

Handbook

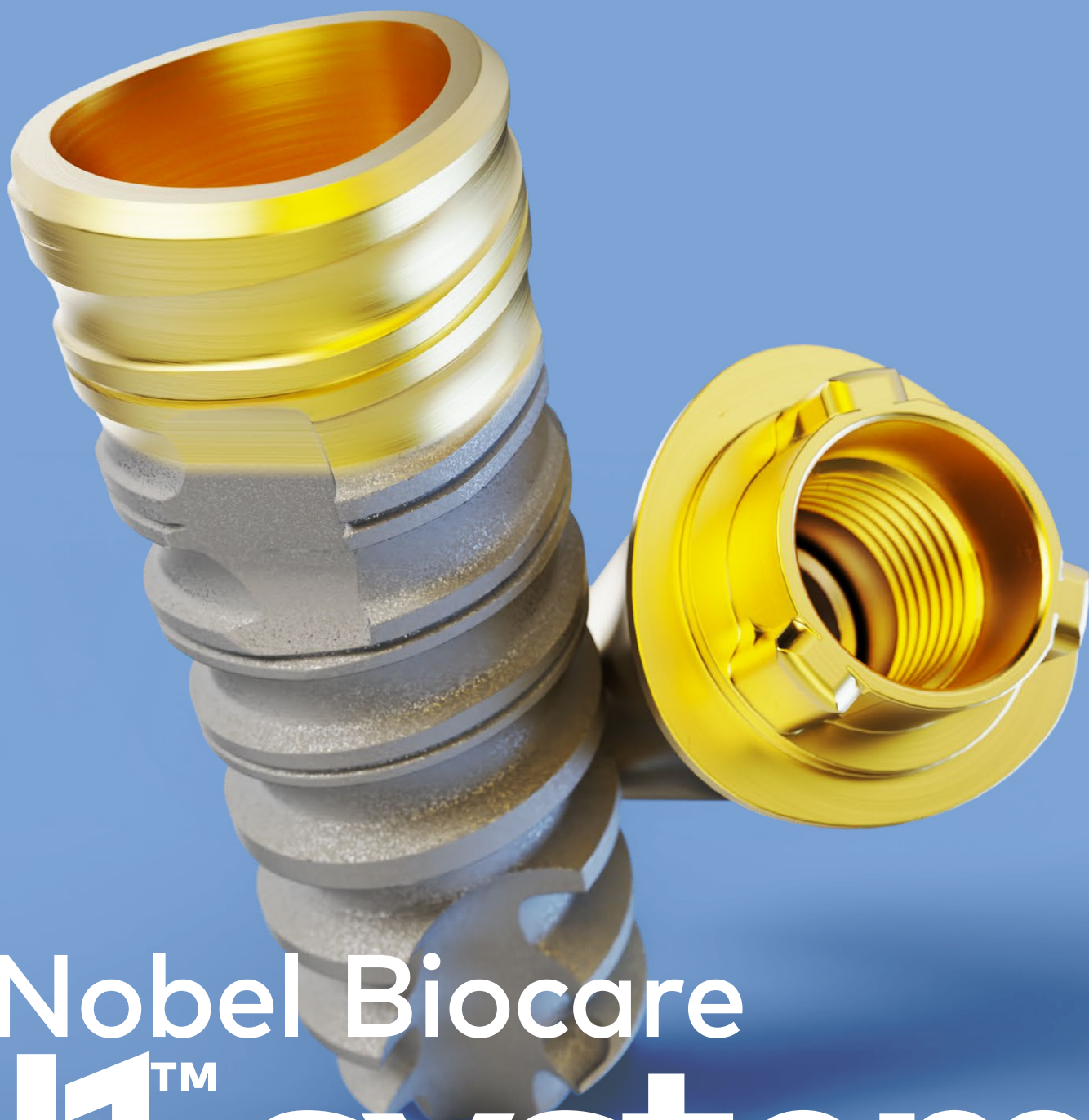

Nobel Biocare
N1TM system

Excellence without compromise

Nobel Biocare N1™
system, for you,
for your patients.

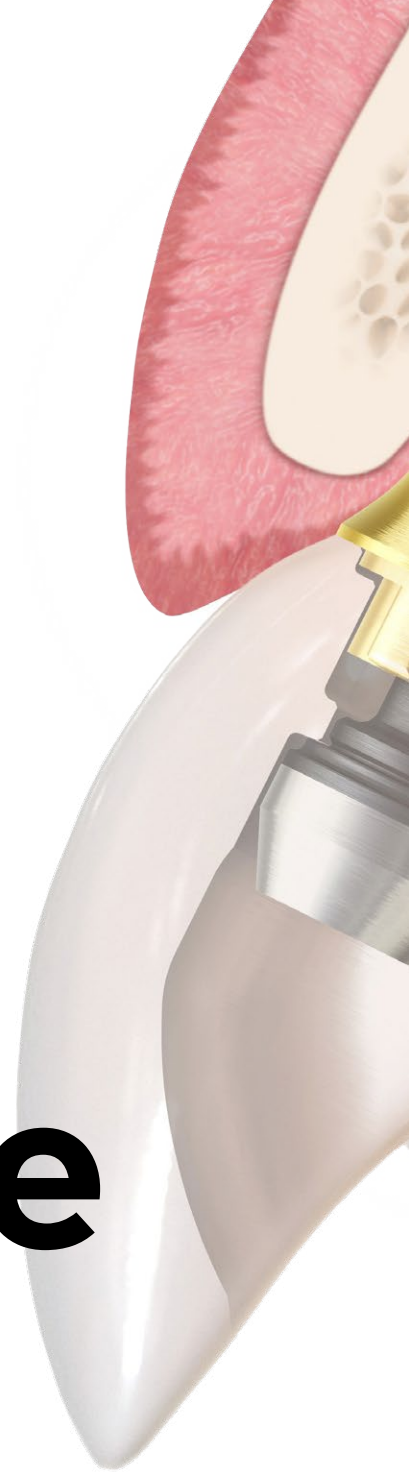



**More than just an implant,
Nobel Biocare N1™ system is a
biologically and esthetically
driven system consisting of
compromise in site preparation,
implant macroshape, prosthetic
connections, emergence profile
and more.**

nobelbiocare.com/n1



Torque symbols used

20
O-Mini

20/15 Ncm



Screwdriver Machine Omnigrip™ Mini

15
O-Mini

Hand
O-Mini

Hand-tighten



Screwdriver Manual Omnigrip™ Mini

20
Base

20 Ncm



Screwdriver Nobel Biocare N1 Base

20
MUA

20 Ncm



Screwdriver Machine Multi-unit

20
Uni

20/15 Ncm



Screwdriver Machine UniGrip

15
Uni

Hand
Uni

Hand-tighten



Screwdriver Manual UniGrip

The scope of this handbook is to provide a comprehensive overview of the surgical steps and options for the Nobel Biocare N1™ system. This handbook does not replace the Instructions For Use (IFU). Please review the Instructions For Use, including Indications For Use, Contraindications, Warnings and Cautions before using the products. Instructions for Use are available at:

ifu.nobelbiocare.com

For a full list of article numbers and for ordering information, refer to the product

overviews available at nobelbiocare.com or contact a Nobel Biocare representative.

Note In order to improve readability, Nobel Biocare does not use ™ or ® in the running text. By doing so, however, Nobel Biocare does not waive any right to the trademark or registered mark and nothing herein shall be construed to the contrary.

Disclaimer Some products may not be regulatorily cleared, released or licensed for sale in all markets. Please contact the local Nobel Biocare sales office for current product assortment and availability.

Contents

Introduction • 7

Quick guide • 8

Implant specifications • 10

Surgical aspects • 13

Instrument overview • 14

Implant packaging • 16

Surgical considerations • 17

Surgical workflow • 18

Depth measurement system • 20

OsseoShaper™ handling considerations • 21

Surgical protocol • 22

Digital workflows • 28

Restorative aspects • 31

Important considerations • 32

Prosthetic portfolio • 36

Nobel Biocare N1™ Base concept • 38

Restorative procedures • 44

Temporary restorations • 45

Final restorations • 52

Impression techniques procedures • 58

Instruments and kits • 69

Surgical PureSet™ • 70

Prosthetic PureSet™ • 72

Appendices • 75

Manual Torque Wrench • 76

How to remove implant level abutments • 78

How to remove the Nobel Biocare N1™ Base • 80

Cleaning and sterilization • 82



Introduction

Quick guide • 8

Implant specifications • 10

Quick guide

Flap technique



OsseoDirector™
instrument



OsseoShaper™ 1
instrument

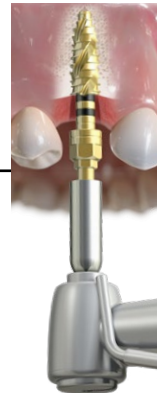

OsseoShaper™ 2
instrument
(if indicated)



Twist Step Drill
(if indicated)

Flapless technique

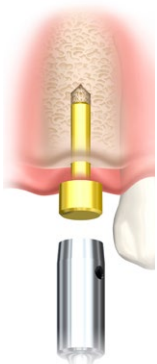

Tissue Punch/
Tissue Punch Guide

Note The illustrations show the drill sequence for a Nobel Biocare N1 RP 4.0 implant in medium bone. For other implant diameters and bone densities, see surgical workflow on [page 18](#).



Implant placement (if indicated)

Implant level



Base level

One-stage Immediate Function

One-stage early/delayed function

Two-stage early/delayed function

One-stage Immediate Function

One-stage early/delayed function



Implant

SPECIFICATIONS

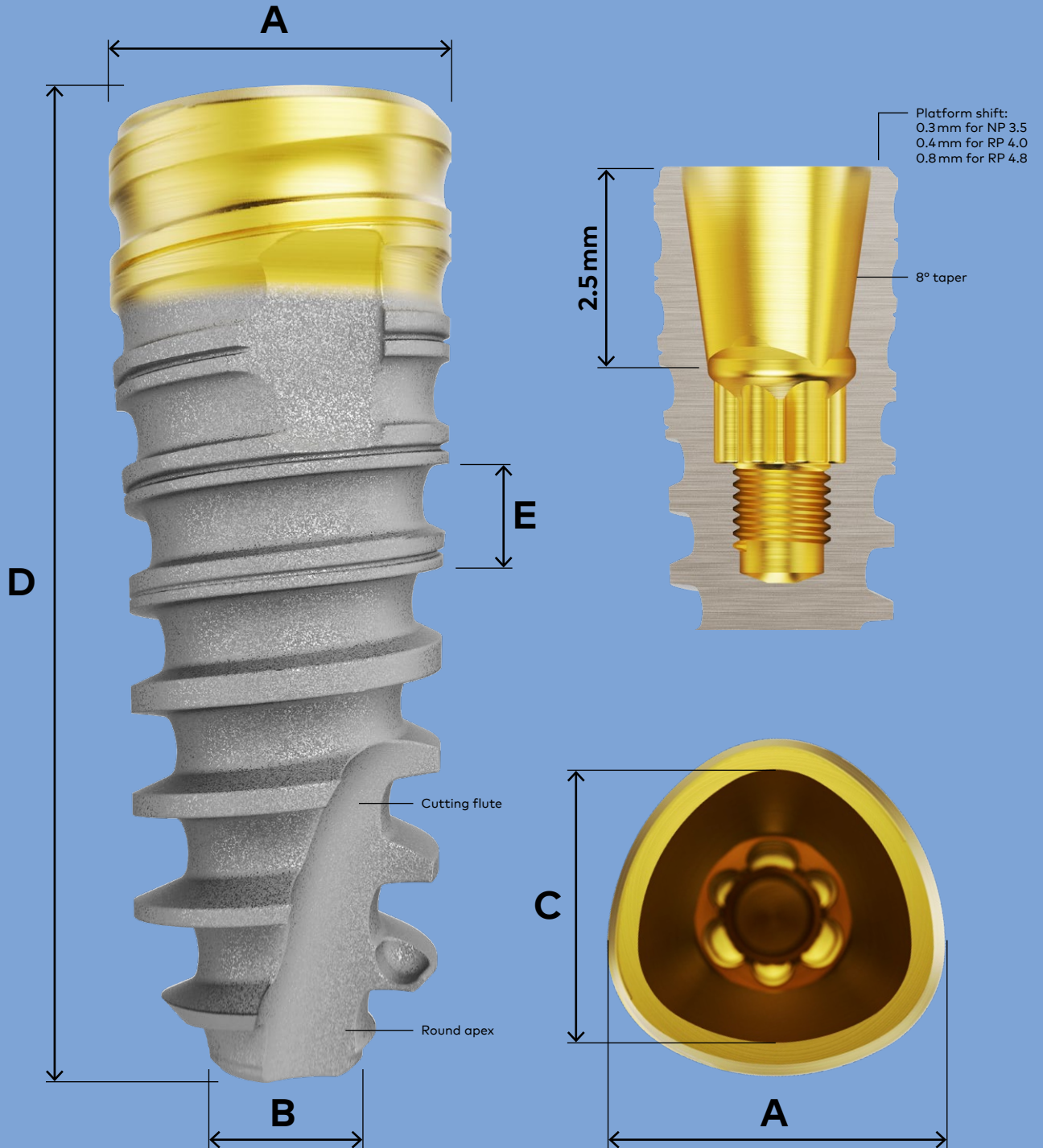

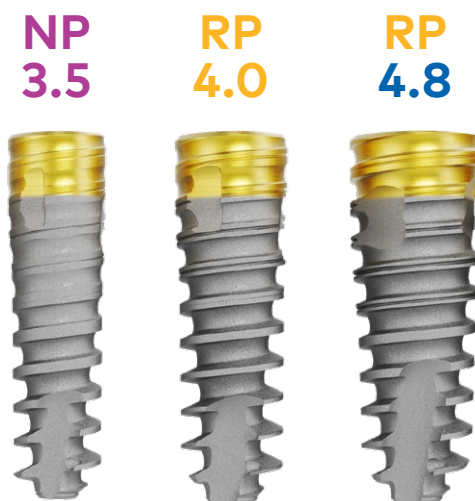

Platform		A Implant size	B Tip diameter	C Abutment interface	D Overall length	E Thread pitch
NP 3.5	3.5×9mm	3.5	1.5	2.9	9	1.2
	3.5×11mm	3.5	1.5	2.9	11	1.2
	3.5×13mm	3.5	1.5	2.9	13	1.2
	3.5×15mm	3.5	1.5	2.9	15	1.2
RP 4.0	4.0×7mm	4.0	1.6	3.1	7	1.2
	4.0×9mm	4.0	1.7	3.1	9	1.2
	4.0×11mm	4.0	1.8	3.1	11	1.2
	4.0×13mm	4.0	1.8	3.1	13	1.2
	4.0×15mm	4.0	1.8	3.1	15	1.2
RP 4.8	4.8×7mm	4.8	1.6	3.1	7	1.2
	4.8×9mm	4.8	1.8	3.1	9	1.2
	4.8×11mm	4.8	1.8	3.1	11	1.2

All measurements in millimeters.

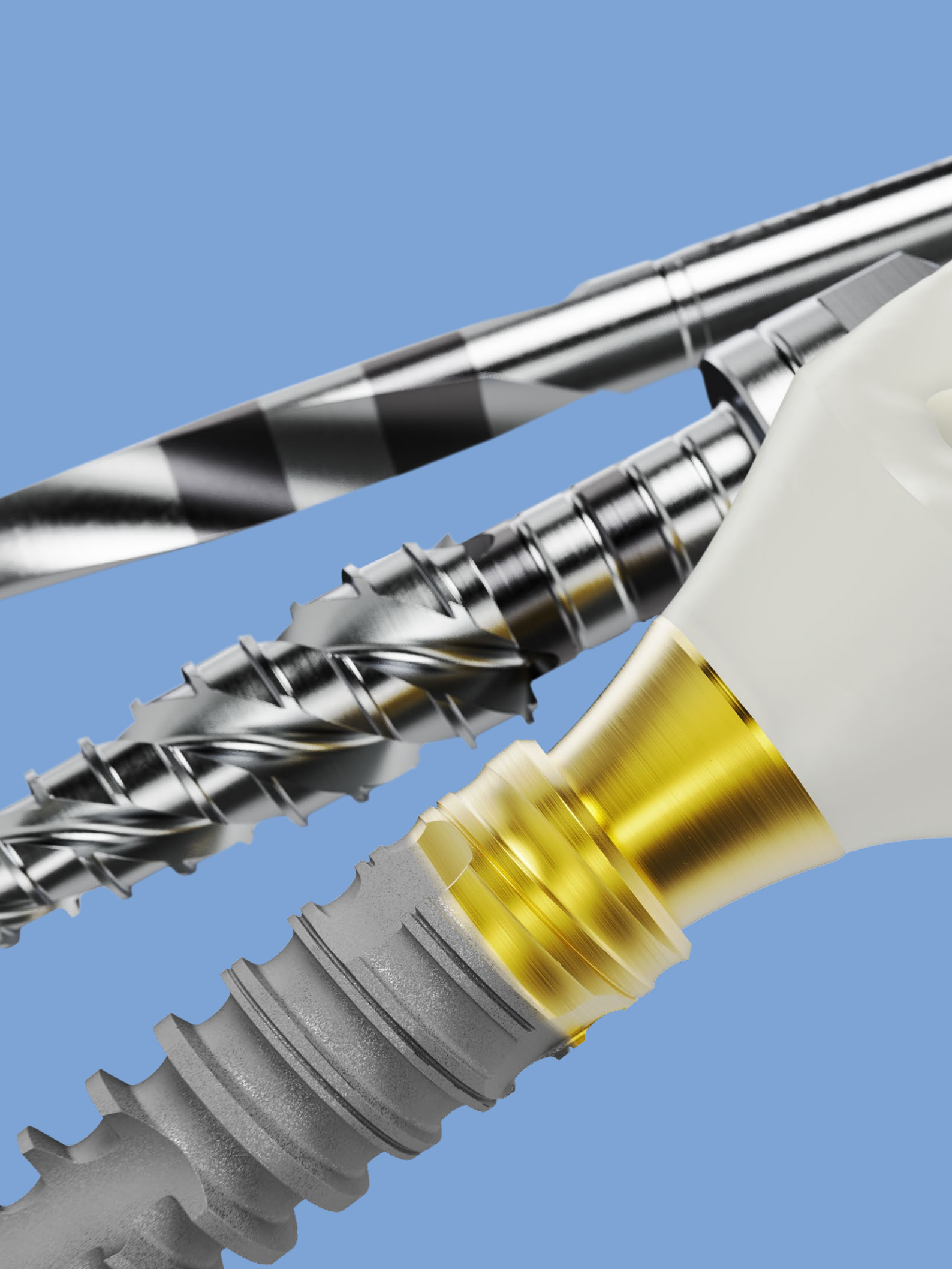

Surgical aspects

- Instrument overview • 14
- Implant packaging • 16
- Surgical considerations • 17
- Surgical workflow • 18
- Depth measurement system • 20
- OsseoShaper™ handling considerations • 21
- Surgical protocol • 22
- Digital workflows • 28

Instrument overview

The Nobel Biocare N1 system is a complete system approach with a full set of site preparation instruments.



The OsseoDirector instrument is a tapered drill with improved cutting capabilities for better directional changes while drilling. It also sets the depth and direction of the Nobel Biocare N1 Implant.

OsseoDirector™ instrument



3.5 4.0 4.8

OsseoShaper™ 1 instrument

A single-use site preparation instrument designed to preserve vital bone by operating at low speed (50 rpm) without irrigation.



3.5 4.0 4.8

A single-use site preparation instrument in the Nobel Biocare N1 protocol used when the implant cannot be placed after the OsseoShaper 1 instrument. It is color-coded based on the implant diameter: magenta for 3.5 mm, yellow for 4.0 mm and blue for 4.8 mm.

OsseoShaper™ 2 instrument

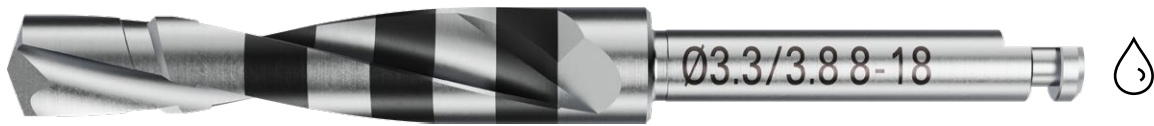

The Twist Step Drill is used if the implant cannot be placed after the OsseoShaper 2 instrument, especially in dense bone situations.

Twist Step Drill



NP RP

Implant Driver Nobel Biocare N1™ TCC

The Nobel Biocare N1 Implant Driver is available in two dimensions and color-coded based on the implant platform: magenta for NP and yellow for RP platform. It has three concave surfaces on the body that align with the flat side of the trioval implant interface. The depth marks identify the implant depth in relation to bone and soft tissue during its placement.



Facilitates initial soft tissue penetration and creation of an initial crestal starting point (also for flap procedure), with contrast marking to prepare the site to the correct depth. Can be used for all Nobel Biocare implants.

Precision Drill

Optional



Guided Pilot Drill

Optional

The Guided Pilot Drill is a straight drill to be used in combination with NobelGuide components. It can be used as an alternative to the OsseoDirector instrument for guided pilot surgery (for detailed instructions refer to Nobel Biocare IFU2001 and IFU2009).

Implant packaging

The cardboard box identifies the Nobel Biocare N1 Implant by highlighting the length, diameter and platform type. The color codes are based on the implant diameter: magenta for 3.5 mm, yellow for 4.0 mm and blue for 4.8 mm.

OsseoShaper 1 comes co-packed: On the side of the box, the quick guide demonstrates how to unbox the implant and release the co-packed OsseoShaper 1 instrument and Nobel Biocare N1 Implant.

Length, diameter and platform type. 'N' indicates that it is a Nobel Biocare N1 implant.

Diagram on how to unbox the OsseoShaper 1 instrument and Nobel Biocare N1 Implant

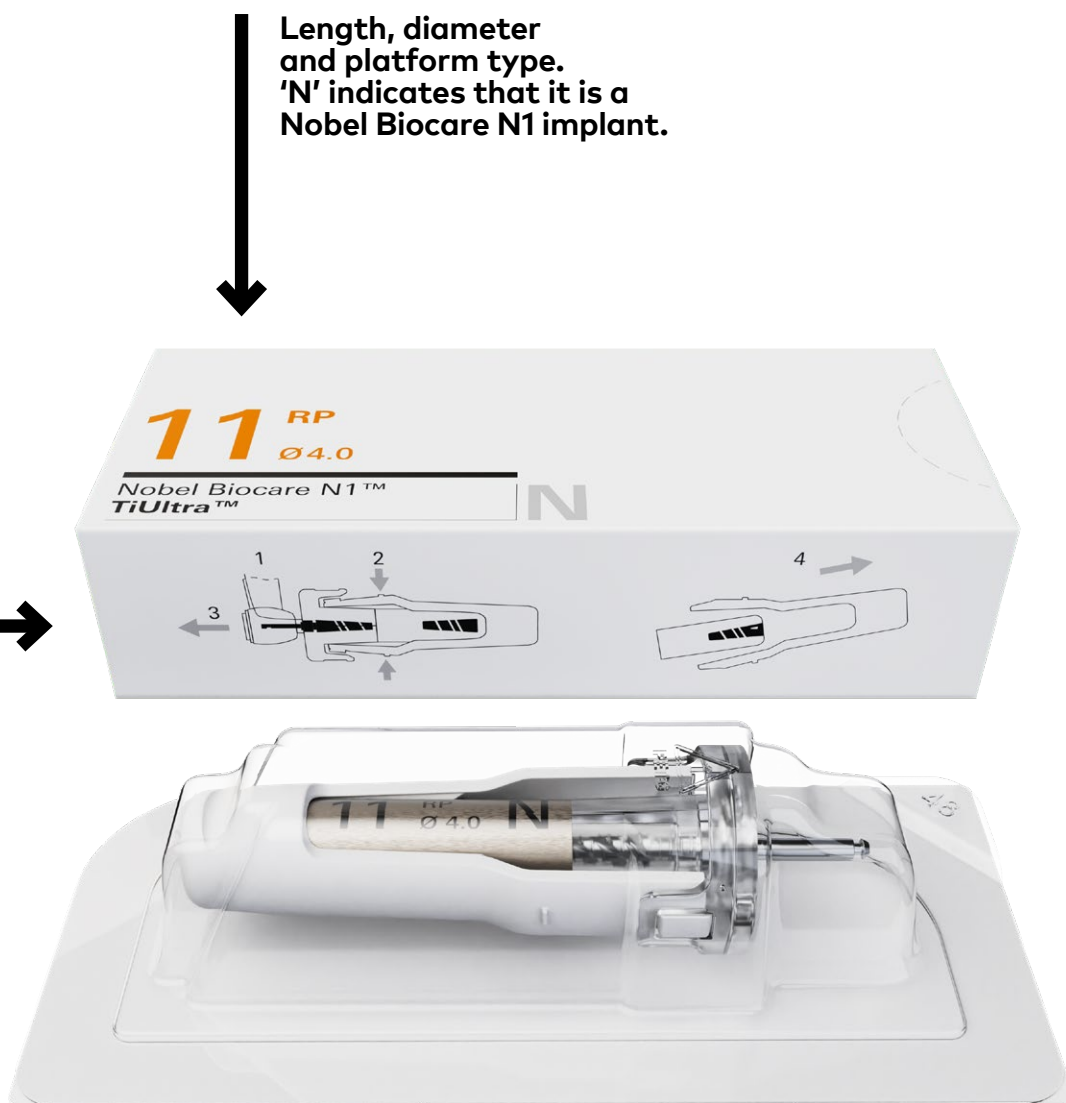

Surgical considerations

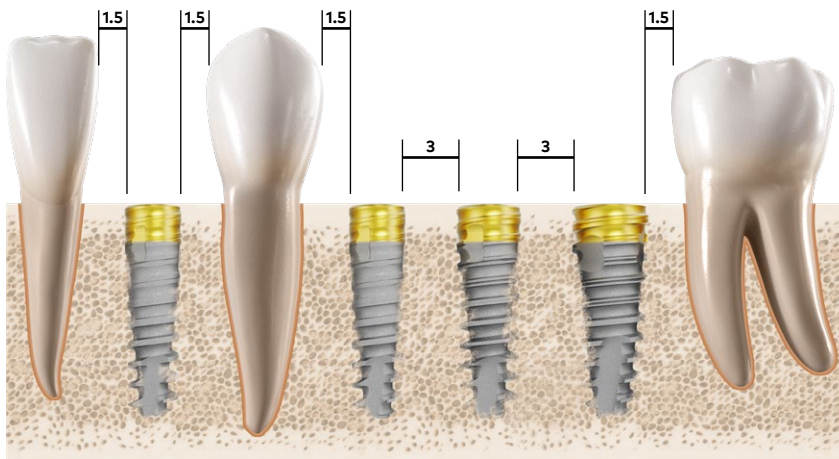

Distance to adjacent teeth

The implants require a minimum distance of 1.5 mm from the neighboring teeth.

Distance to adjacent implants

The distance between the implants should be at least 3 mm.



Biological width

It is generally advised to maintain a minimum of 3 mm of soft tissue height from implant to free gingival margin. Based on available soft tissue volume this might result in a crestal or subcrestal implant placement.

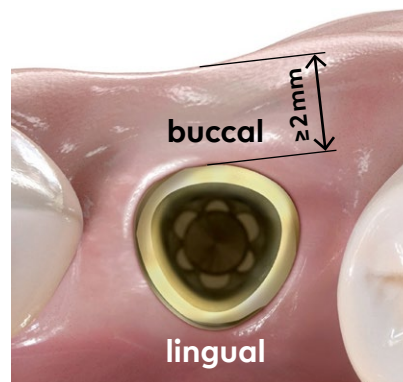

Implant positioning

The implant should be positioned such that the flat side of the trioval shape faces buccally, in order to maximize buccal wall volume at the time of implant placement. Adjust the orientation with the Manual Torque Wrench Surgical.

It is generally advised to maintain a minimum of 2 mm buccal bone thickness.

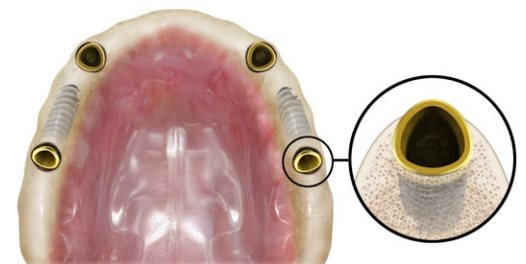

Tilted implant positioning

When the implant is placed in a tilted position, in for instance the All-on-4 treatment concept, it should be placed with flat side of the trioval shape facing the bone. This will allow the screw hole of the angled Multi-unit Abutment to be oriented correctly.

Surgical workflow

The osteotomy is created using the OsseoDirector and OsseoShaper instruments. The OsseoShaper instrument is a threaded device that is inserted and removed at low speed without irrigation. They replace the conventional drills used for creating the osteotomy.

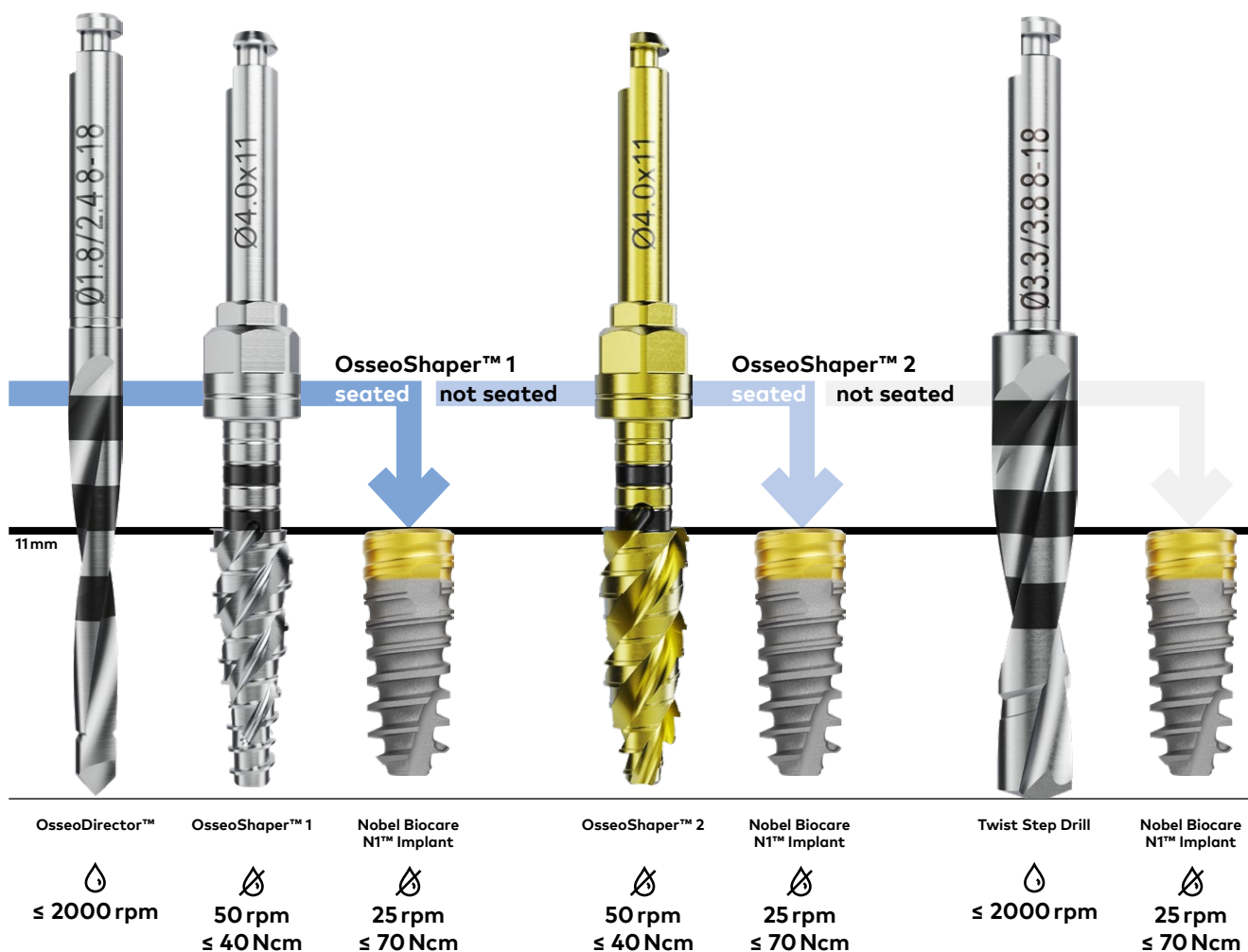

Above demonstrates the surgical protocol based on the Nobel Biocare N1 TiUltra TCC RP 4.0x11 mm implant.

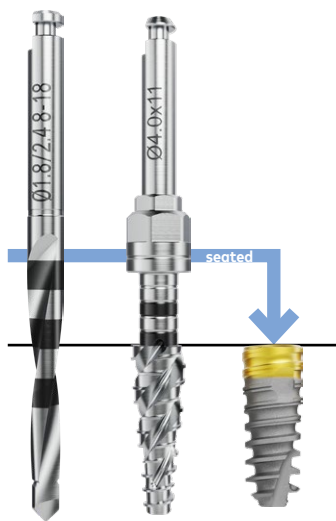

Below 40 Ncm insertion torque for the OsseoShaper™ 1 instrument

Only a few surgical instruments are needed with the introduction of the OsseoShaper concept.

When the OsseoShaper 1 instrument is fully seated to the intended depth within the torque of max. 40 Ncm, you can proceed with implant placement.

In cases where the OsseoShaper 1 instrument cannot be fully seated, the OsseoShaper 2 instrument must be used in order to place the implant.



Below 40 Ncm insertion torque for the OsseoShaper™ 2 instrument

The OsseoShaper 2 instrument is used with the same parameters (speed and insertion torque) as the OsseoShaper 1 instrument.

When the OsseoShaper 2 instrument is fully seated to the intended depth within the torque of max. 40 Ncm, you can proceed with implant placement.

In cases where the OsseoShaper 2 instrument cannot be fully seated, you must use the Twist Step Drill to place the implant.

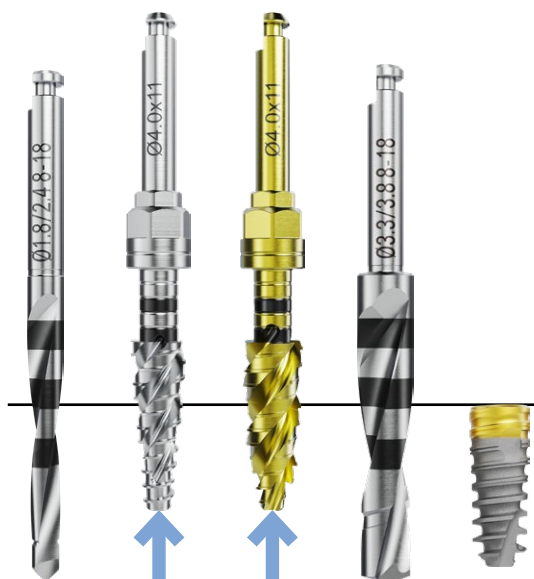

Above 40 Ncm Insertion torque above the intended limit of the OsseoShaper 2 instrument

The Twist Step Drill is used within the same parameters used for the OsseoDirector instrument (≤ 2000 rpm, constant and profuse irrigation).

Depth measurement system

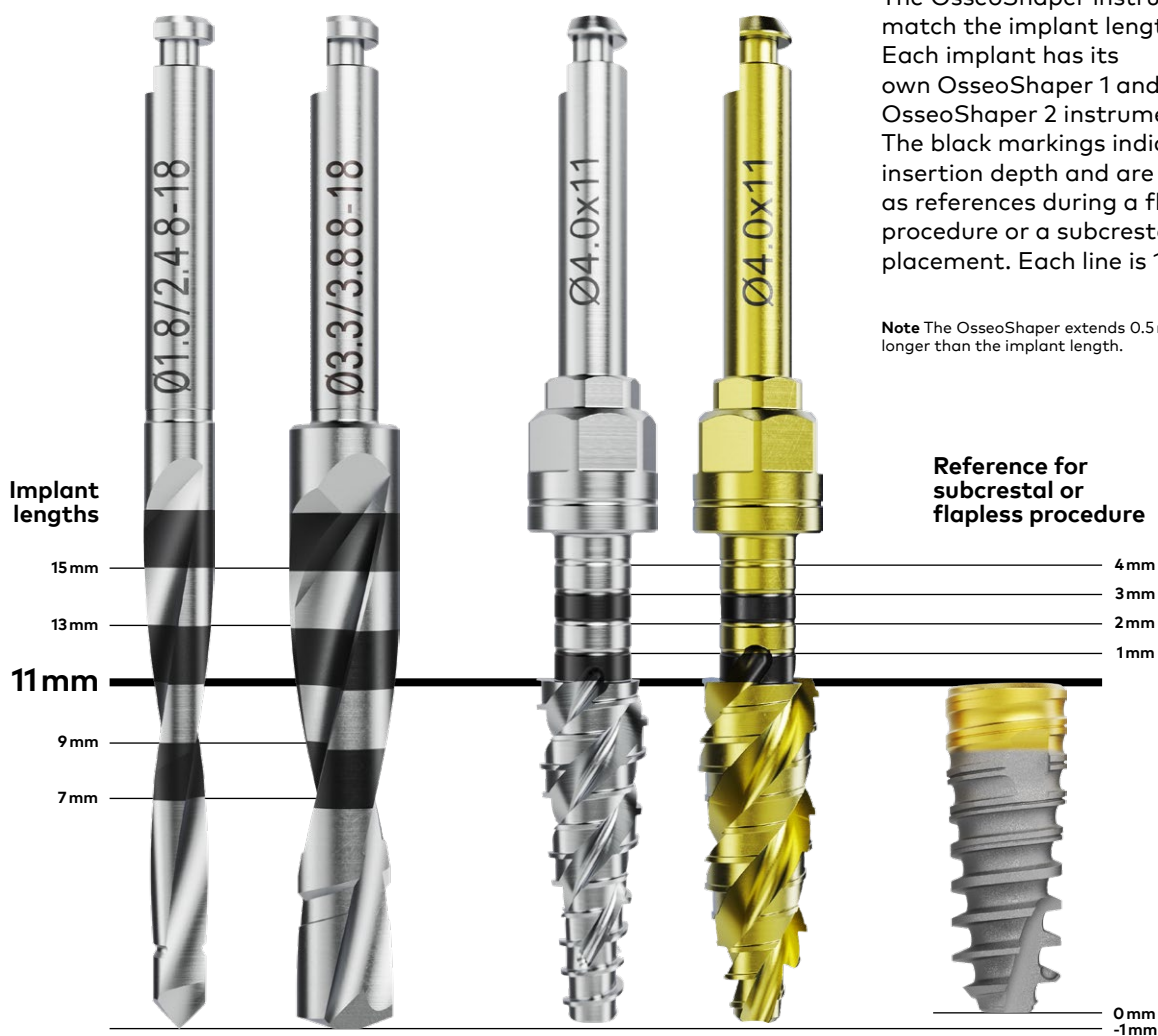

The OsseoShaper instruments match the implant lengths. Each implant has its own OsseoShaper 1 and OsseoShaper 2 instruments. The black markings indicate the insertion depth and are used as references during a flapless procedure or a subcrestal planned placement. Each line is 1mm thick.

Note The OsseoShaper extends 0.5mm longer than the implant length.

The OsseoDirector instrument and the Twist Step Drill present depth marking corresponding to the implant lengths. Each line is 2mm thick.

Caution The OsseoDirector instrument, Guided Pilot Drill, and Twist Step Drill extend up to 1mm longer than the implant length when seated. Allow for this additional length when drilling near vital anatomical structures.

OsseoShaper™ handling considerations

Insertion

Both OsseoShaper 1 and 2 have a leading thread that draws the OsseoShaper into the osteotomy. During insertion avoid applying pressure on the OsseoShaper via the hand piece. Instead let the OsseoShaper be drawn into the site itself.

Keep a steady hand into soft bone to allow it to follow the osteotomy created by the OsseoDirector.



Depth Control

The OsseoShaper depth placement is controlled by the foot pedal. To stop the OsseoShaper from going deeper once the intended depth is reached, stop pressing the foot pedal.

Remove the OsseoShaper from the site by placing the drill unit in reverse mode without applying pressure on the handpiece while being removed.

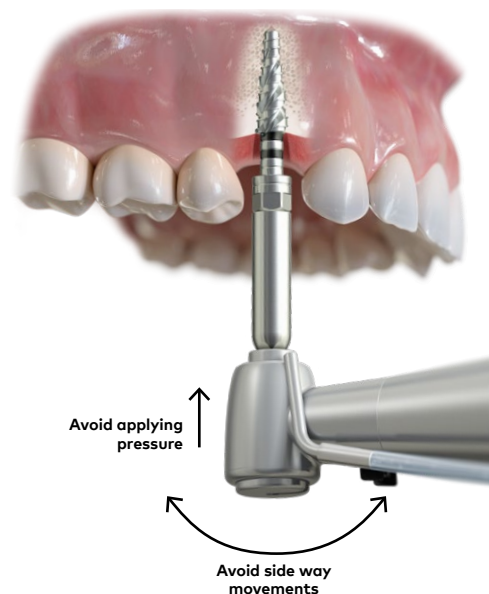

Handling in soft bone

Once the OsseoShaper has reached the intended depth, proceed to immediately remove it from the site by placing the drill unit in reverse mode.

Avoid inducing any side way movements on the hand piece during the removal of the OsseoShaper as this might enlarge the implant site.

Handling in Dense Bone

Dense bone situations might result in the cutting flutes of the OsseoShaper 2 being full of bone debris. This might negatively impact the cutting behaviour of the OsseoShaper 2.

When the OsseoShaper 2 is used in dense bone and is almost seated to intended depth or is fully seated it is advisable to clean the cutting flutes from bone debris and prepare the site to full depth with the OsseoShaper 2 once again.



Surgical protocol

Preparation of osteotomy

1 Setup

The OsseoDirector must run at high speed until the full depth to successfully prepare the site for the implant (maximum 2000 rpm), and under constant and profuse irrigation by sterile saline at room temperature.

💧 ≤2000 rpm

With the OsseoDirector instrument you determine the final implant position, it is important to drill until the full depth in order to successfully prepare the site for the implant.

Caution The OsseoDirector Nobel Biocare N1 extends up to 1mm longer than the implant length. Allow for this additional length when drilling near vital anatomical structures.



2 Osteotomy preparation

Prepare the osteotomy with the OsseoDirector instrument at the planned depth. In situations in which adjacent natural teeth interfere with the contra-angle head, the OsseoShaper Extension can be used together with the OsseoDirector instrument.

The OsseoDirector instrument allows you to change direction and inclination while drilling.

Warning The OsseoDirector instrument, Guided Pilot Drill, OsseoShaper instruments and Twist Step Drills are sharp instruments. Handle with care to prevent injury.



3 Orientation check

Check the orientation of the osteotomy with the Direction Indicator. The depth probe is used to check the right depth of the osteotomy.

The Direction Indicator has two sides: the tapered side fits the osteotomy created with the OsseoDirector instrument and the other side (straight) fits the osteotomy created with the Guided Pilot Drill.

Note It is recommended to use a suture thread through the hole to prevent aspiration.

Caution Use of the wrong depth probe can result in incorrect measurement of the osteotomy depth. The Depth Probe Nobel Biocare N1 must be used.



4 Setup OsseoShaper instrument

Drill unit set with maximum speed of 50 rpm, and insertion torque at 40 Ncm with no irrigation.

⚠ 50 rpm / 40 Ncm

Caution The drill unit must indicate the inserting torque while drilling. Exceeding 40 Ncm may damage the contra-angle and related tooling.

 Pickup (pristine environment): Engage the OsseoShaper 1 as explained in the video tutorial accessible through the QR code.



5 Drilling

Insert the OsseoShaper 1 instrument by drilling in a forward direction to the intended depth or until it prematurely stops. Remove the foot from the foot pedal to stop the OsseoShaper 1 from going deeper into the osteotomy once the intended depth is reached. Then reverse mode at 50 rpm to pull it out.

Warning Allow the OsseoShaper 1 instrument to feed in without applying pressure. It will follow the osteotomy created by the OsseoDirector instrument. Never exceed the insertion torque of 40 Ncm.

Extension can also be used together with the OsseoShaper 1 instrument if interferences with contra-angle.

Warning Do not apply excessive forces while using both OsseoShaper instruments to avoid injuring underlying vital structures.

Caution Ensure OsseoShaper instruments are fully inserted in the contra-angle. They may become stuck if incorrectly assembled. Using the OsseoShaper instruments at speeds greater than 50 rpm may damage the bone.

Caution Never exceed insertion torque of 40 Ncm for both OsseoShaper instruments. Overtorquing may lead to fracture or necrosis of the bone, or to damage of tooling such as contra-angle or OsseoShaper Extension.

Caution The drill unit maximum torque must be set to 40 Ncm. Exceeding 40 Ncm may damage the contra-angle and related tooling.



6 Next steps

As soon as the OsseoShaper 1 instrument has reached the desired depth and position in accordance with the preoperative planning, proceed with the implant placement (see [page 26](#)) or go to step 7 ([page 24](#)).

7 Setup OsseoShaper instrument

Drill unit set with maximum speed of 50 rpm, and insertion torque at 40 Ncm with no irrigation.

⚙️ 50 rpm / 40 Ncm

Caution The drill unit must indicate the inserting torque while drilling. Exceeding 40 Ncm may damage the contra-angle and related tooling.

8 Select OsseoShaper 2 instrument

Select the OsseoShaper 2 instrument size that corresponds to the implant length and diameter.



9 Setup

Set up the drill unit with maximum speed of 50 rpm, insertion torque at 40 Ncm and no irrigation.

⚙️ 50 rpm / 40 Ncm

Warning Do not apply excessive forces while using the OsseoShaper 1 instrument to avoid damaging vital structures.

Caution Do not pull the OsseoShaper 1 instrument out from the osteotomy without setting the reverse mode to avoid damaging the osteotomy.

Caution Ensure the OsseoShaper instrument is fully inserted in the contra-angle. The OsseoShaper instrument may become stuck if incorrectly assembled.

10 Drilling

Insert the OsseoShaper 2 instrument by drilling in a forward direction to the intended depth or until it prematurely stops. Do not exceed 40 Ncm insertion torque in both ways. Remove foot from the foot pedal to stop the OsseoShaper 2 from going deeper into the osteotomy once the intended depth is reached. Then reverse mode at 50 rpm to pull it out.

Warning Allow the OsseoShaper 1 instrument to feed in without applying pressure. It will follow the osteotomy created by the OsseoDirector instrument. Never exceed the insertion torque of 40 Ncm.

Extension can also be used together with the OsseoShaper 1 instrument if interference with contra-angle.

Warning Do not apply excessive forces while using OsseoShaper instruments to avoid injuring underlying vital structures.



Caution Ensure OsseoShaper instruments are fully inserted in the contra-angle. They may become stuck if incorrectly assembled. Using the OsseoShaper instruments at speeds greater than 50 rpm may damage the bone.

Caution Never exceed insertion torque of 40 Ncm for OsseoShaper instruments. Overtorquing may lead to fracture or necrosis of the bone, or to damage of tooling such as contra-angle or OsseoShaper Extension.

Caution The drill unit maximum torque must be set to 40 Ncm. Exceeding 40 Ncm may damage the contra-angle and related tooling.

11 Next steps

If the OsseoShaper 2 instrument is fully seated to the defined depth within the torque of max. 40 Ncm proceed with the implant placement (see [page 26](#)), otherwise proceed with the Twist Step Drill (step 12 on [page 25](#)).

12 Select Twist Step Drill

Select the Twist Step Drill that corresponds to the implant diameter.



13 Setup

Set up the drill unit at high speed (maximum 2000 rpm) with irrigation, and engage the Twist Step Drill to the handpiece.

💧 ≤2000 rpm

14 Drilling

Drill forward at the planned depth in order to widen the osteotomy. In situations where adjacent natural teeth interfere with the contra-angle head, the OsseoShaper Extension can be used together with the Twist Step Drill.

Proceed with the implant placement (see [page 26](#)).



Implant placement

1 Access implant

To pick up the implant, rotate the packaging and remove the protective sleeve (a).

2 Pick up implant

Use the Nobel Biocare N1 Implant Driver to pick up the implant from the titanium sleeve (b).

Set up the drilling unit with maximum speed of 25 rpm and maximum insertion torque of 70 Ncm.

25 rpm / 70 Ncm

To engage the implant, hold the titanium sleeve and slowly rotate the implant driver. It will automatically engage the implant.



3 Insert implant

Insert the implant using the contra-angle proceeding forward at 25 rpm without irrigation.

The implant should be positioned such that the flat side of the trioval shape faces buccally, in order to maximize buccal wall volume at the time of implant placement. Adjust the orientation with the Manual Torque Wrench Surgical.

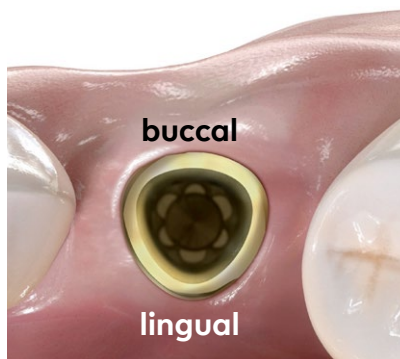

4 Final placement

The Manual Torque Wrench Surgical can be used for the final placement or to correct the orientation of the implant if needed.

Caution Never exceed insertion torque of 70 Ncm for the implant. Prosthetic torque should never exceed 25 Ncm.

Overtightening may damage the implant unit and/or fracture or necrosis of the bone site. If a surgical driver is used to insert the implant, take special care to avoid overtightening. For immediate loading the implant should withstand a final insertion torque of at least 35 Ncm. If this insertion torque value is not achieved, other loading protocols may be considered in accordance with the indications for use of the device.



Digital workflows

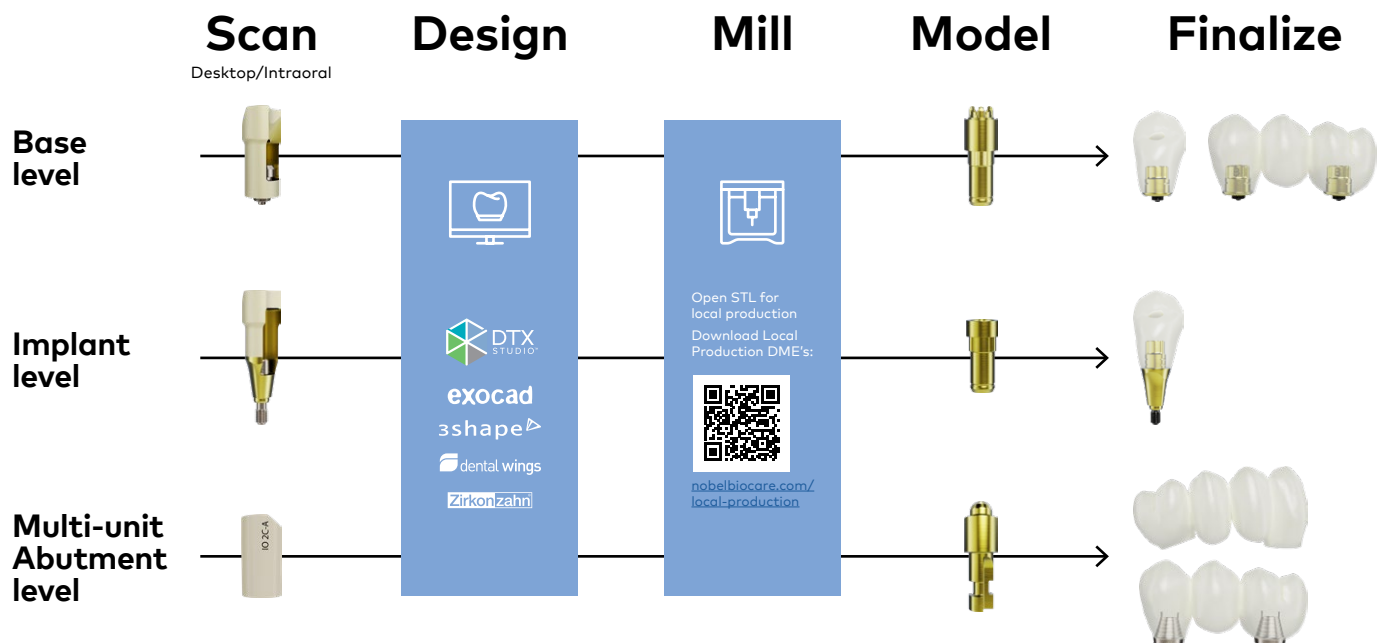

Pilot guided surgery

Plan and place Nobel Biocare N1 system with high accuracy and precision with pilot guided surgery tools from Nobel Biocare. Place according to plan.

See procedure on [page 29](#)



Navigated surgery

The Nobel Biocare N1 system is compatible with the X-Guide 3D navigation system. This advanced technology provides real-time interactive guidance for drill positioning during surgeries, enabling improvements in the precision and accuracy of implant placement, including position, angle, and depth.

Pilot guided surgery

1 Seat template

Seat the surgical template.

For detailed instructions on NobelGuide components refer to Nobel Biocare IFU2001 and IFU2009.



2 Drilling

Engage the Guided Pilot Drill with the handpiece and drill the full planned depth.

The Guided Pilot Drill must proceed at high speed, maximum 2000 rpm and under constant and profuse irrigation by sterile saline at room temperature.

⚠ ≤2000 rpm



3 Remove template

Remove the surgical template and proceed with the OsseoDirector and OsseoShaper 1.

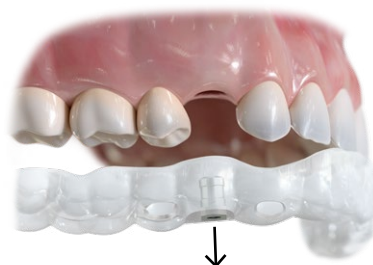



Restorative aspects

Important considerations • 32

Prosthetic portfolio • 36

Nobel Biocare N1™ Base concept • 38

Restorative procedures • 44

Temporary restorations • 45

Final restorations • 52

Impression techniques procedures • 58

Important considerations

Working at base or implant level

When executing the implant treatment with Nobel Biocare N1 System, the clinician can choose whether the restorative procedure should be done at implant level or base level.

Base level

Trioval design of the Base resembles the teeth in the esthetic zone.

The Base concept supports the preservation of connective tissue structures throughout the prosthetic procedure.

Implant level

Implant level abutments and components have harmonized slim emergence profiles.

The components self-align into the right position within the implant connection.



Emergence profiles

Margin height
1.5 mm

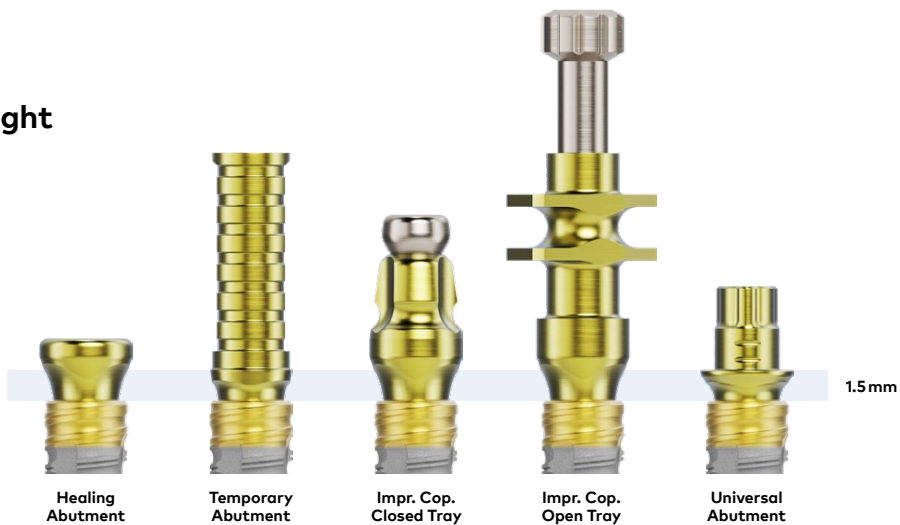

Margin height
3.0 mm



Tightening torques

Nobel Biocare
N1 Base

Healing and impression
taking components

Temporary and
final abutments

Temporary and
final abutments

20
Base

Hand
O-Mini

20
O-Mini

Base
level

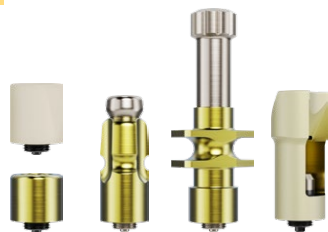

Implant
level

Hand
O-Mini

20
O-Mini



Multi-unit
Abutment
level

20
O-Mini



20
MUA



* At Multi-unit Abutment level the tightening torque is 15Ncm. Depending on the type of restoration, a Unigrip or Omnigrip mini screwdriver is used in order to connect the restoration with the abutment.

Prosthetic components



How to identify platforms

All prosthetic components in the Nobel Biocare N1 portfolio feature anodized surfaces.

Temporary Abutments and Universal Abutments, regardless of the platform, have a golden hue. In order to distinguish NP from RP abutments, the screw heads are color coded. The marking follows the scheme: magenta for narrow platform and yellow for regular platform components.



How to identify trioval conical connection versus conical connection

Multi-unit Abutments with trioval conical connection feature laser markings containing information on the connection, platform and abutment height. This information, as well as the black screw head of the straight abutments, make them distinguishable from conical connection Multi-unit Abutments.



How to identify bridge components

To allow identification of restorative components for bridges, they have a laser-marked "B" on the abutment post. When taken out of the package they can be visually identified.

Prosthetic portfolio



Base level



Universal Abutment screw-retained crowns

Angulated screw channel (0–20°)



Esthetic Abutment cement-retained crowns



NobelProcera zirconia crown with angulated screw channel

Angulated screw channel (0–25°)

Implant level



Universal Abutment screw-retained crowns



Esthetic Abutment cement-retained crowns



Ti-Blanks TCC

Multi-unit Abutment level



**Esthetic Abutment
cement-retained
bridges**



**Universal
Abutment screw-
retained bridges**

Angulated screw
channel (0–20°)



**Esthetic Abutment
cement-retained
bridges**



Ti-Blanks TCC



**NobelProcera Titanium
fixed implant bar**



**Universal Base for
Multi-unit Abutment**



**NobelProcera Zirconia
Implant Bridge (2-14 units)**

Nobel Biocare N1™ Base concept

The peri-implant soft tissue interface plays an important role in the long-term success of implant-supported restorations. While there are many factors that contribute to the success or failure of implant-supported restorations, the quality and the quantity of peri-implant mucosa plays a critical role.

The peri-implant soft tissue interface can be affected by several characteristics including:

- material and surface topography of the implant and abutment
- the abutment/implant connection design
- prosthetic manipulations (e.g. repeated abutment detachment)

“One abutment, one time” concept

Those findings led to the development of a soft-tissue-friendly concept of abutment placement at the time of implant surgery.

With this method, the final abutment is installed and left undisturbed throughout the treatment process. This component is the novel Nobel Biocare N1 Base.

2-piece abutment, placed at the time of implant surgery, remains in situ throughout the entire prosthetic procedure to preserve the connective tissue structure.

The base is trioval and features Xeal surface, embracing the Mucointegration concept.



References

Wang Y, Zhang Y & Miron R. J. Health Maintenance, and Recovery of Soft Tissues around implants. *Clin Implant Dent Relat Res* 18, 618-634, (2016)

Atsuta, I. et. al. Soft tissue sealing around dental implants based on histological interpretation. *J Prosthodont Res* 60, 3-11, (2016)

Canullo, L. Bignozzi, I. Cocchetto, R. Cristalli, M. P. & Iannello, G. Immediate positioning of a definitive abutment versus repeated abutment replacements in post-extractive implants: 3-year follow-up of randomised multicentre clinical trial. *Eur J Oral Implantol* 3, 285-296, (2010)

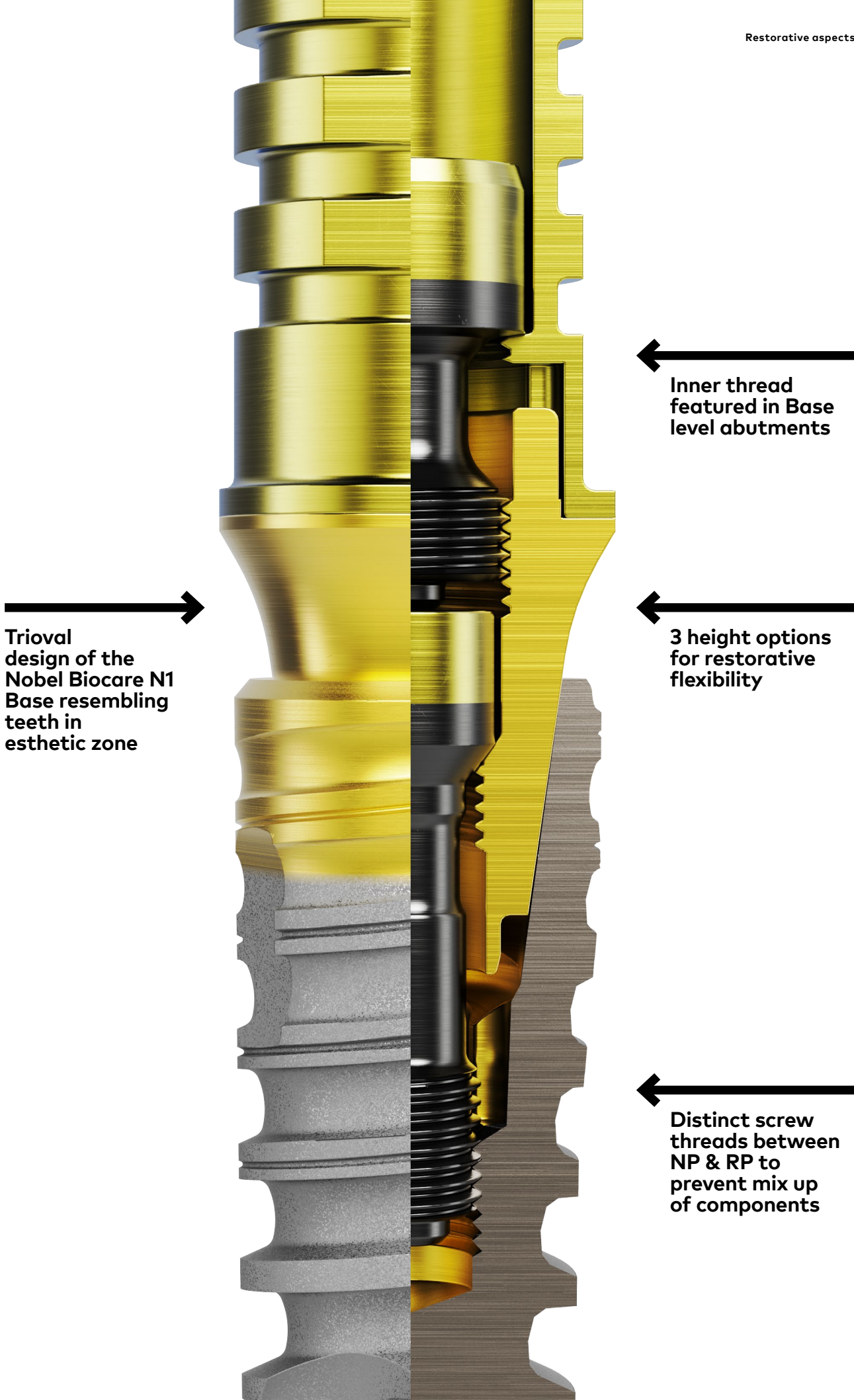

Trioval design of the Nobel Biocare N1 Base resembling teeth in esthetic zone

Inner thread featured in Base level abutments

3 height options for restorative flexibility

Distinct screw threads between NP & RP to prevent mix up of components

20
Base



Screwdriver Nobel Biocare N1 Base
Available in 28 mm and 36 mm length



Built-in safety break (about 30 Ncm)

When over-torquing the abutment screw, the driver will break leaving the screw abutment, and implant intact.

Studies show that factors like prosthetic abutment height can be one of key factors in peri-implant bone levels. Therefore right component selection can play an important role in the overall treatment outcome¹.

For that reason we are introducing three height options for the Nobel Biocare N1 Base: 1.75 mm, 2.5 mm and 3.5 mm for both Narrow Platform and Regular Platform implants.

The clinician can choose the right one based on the patient's anatomical situation and the position of the implant.

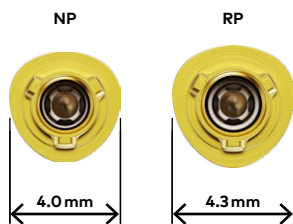

1. Galindo-Moreno P, Leon-Cano. A., Ortega-Oller. I, et. al. Prosthetic Abutment Height is a Key Factor in Peri-implant Marginal Bone Loss J Dent Res. 2014 Jul; 93(7 Suppl): 80S-85S

Xeal™ - The pioneering Mucointegration™ surface¹⁻³

Tissue integration begins here. Dense soft tissue contact with an abutment can act as a barrier that protects the underlying bone. This is the basis for long-term tissue health and stability.⁴⁻⁷

Xeal is a pioneering surface for soft-tissue integration¹⁻³

It is a smooth, non-porous, nanostructured and anodized surface and possesses surface chemistry and topography that are specially designed to promote soft-tissue attachment.^{1,8}

Golden color for natural appearance

The distinctive golden color occurs naturally during the manufacturing process. The hue also presents a natural appearance in the transmucosal zone.⁸

Pristine surface

Preserving the surface chemistry and hydrophilicity.⁹

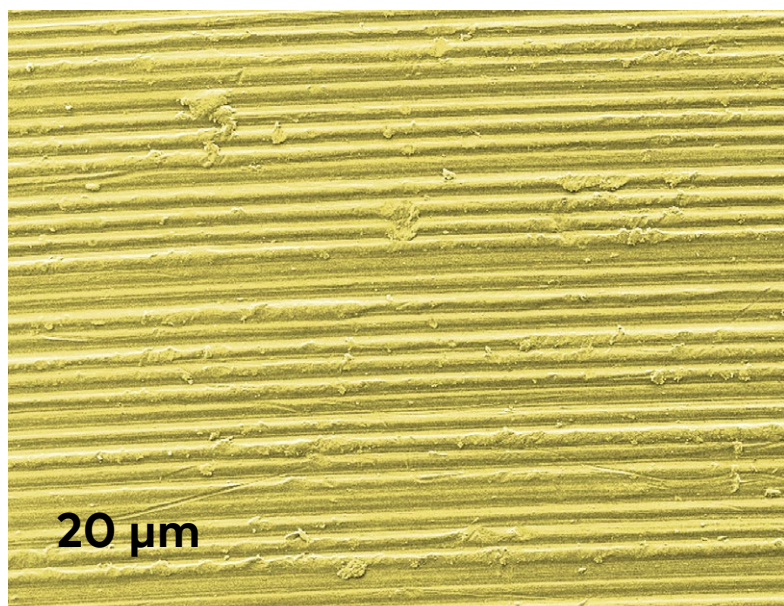

1. Susin C, Finger Stadler A, Fiorini T, et al. Safety and efficacy of a novel anodized abutment on soft tissue healing in Yucatan mini-pigs. *Clin Implant Dent Relat Res* 2019;21(Suppl 1):34-43.
2. Roffel S, Wu G, Nedeljkovic I, et al. Evaluation of a novel oral mucosa in vitro implantation model for analysis of molecular interactions with dental abutment surfaces. *Clin Implant Dent Relat Res* 2019;21(Suppl 1):25-33.
3. Hall J, Neilands J, Davies JR, et al. A randomized, controlled, clinical study on a new titanium oxide abutment surface for improved healing and soft tissue health. *Clin Implant Dent Relat Res* 2019;21(Suppl 1):55-68.
4. Rompen E, Domken O, Degidi M, et al. The effect of material characteristics, of surface topography and of implant components and connections on soft tissue integration: a literature review. *Clin Oral Implants Res* 2006;17(Suppl 2):55-67.
5. Alva H, Prasad KD, Prasad AD. Bioseal: The physiological and biological barrier for osseointegrated supported prosthesis. *J Dent Implant* 2013;3:148-152.
6. Touati B, Rompen E, Van Dooren E. A new concept for optimizing soft tissue integration. *Pract Proced Aesthet Dent* 2005;17(10):711-715.
7. Schupbach P, Glauser R. The defense architecture of the human periimplant mucosa: a histological study. *J Prosthet Dent* 2007;97(6 Suppl):S15-25.
8. Nobel Biocare. Data on file.
9. Milleret V, Lienemann PS, Gasser A, et al. Rational design and in vitro characterization of novel dental implant and abutment surfaces for balancing clinical and biological needs. *Clin Implant Dent Relat Res* 2019;21(Suppl 1):15-24.

Procedure

The procedure below only describes the handling of the Nobel Biocare N1 Base. For additional details on procedures at Base level, please refer to the following modules of the handbook.

 **Video Nobel Biocare N1 Base placement on a central incisor.**

1 Insert

Select an appropriate Nobel Biocare N1 Base Xeal and connect it to the implant using the pre-assembled handle to facilitate the insertion and avoid touching the surface of the device. Remove the handle.



20 Ncm, Screwdriver Nobel Biocare N1 Base

20
Base



2 Tighten

Tighten the Clinical Screw of the Nobel Biocare N1 Base.

Hand-tighten the Clinical Screw Nobel Biocare N1 Base using the Screwdriver Nobel Biocare N1 Base.

If an Impression Coping, Temporary Abutment, or Universal Abutment will be placed on the Nobel Biocare N1 Base Xeal, tighten the Clinical Screw Nobel Biocare N1 Base to 20 Ncm using the Screwdriver Nobel Biocare N1 Base and Manual Torque Wrench Prosthetic.

Caution Never exceed 20 Ncm tightening torque for Nobel Biocare N1 Base Xeal. Overtightening the Clinical Screw may lead to a screw fracture. Built-in safety-break set around 30 Ncm.



Removal

If removal of the Nobel Biocare N1 Base Xeal is needed, untighten the screw using the Screwdriver Nobel Biocare N1 Base.

It is recommended to verify the final seating of the Nobel Biocare N1 Base and the components attached using radiographic imaging. Nobel Biocare N1 Base Xeal should only be replaced in conjunction with the Clinical Screw Nobel Biocare N1 Base.



Restorative procedures

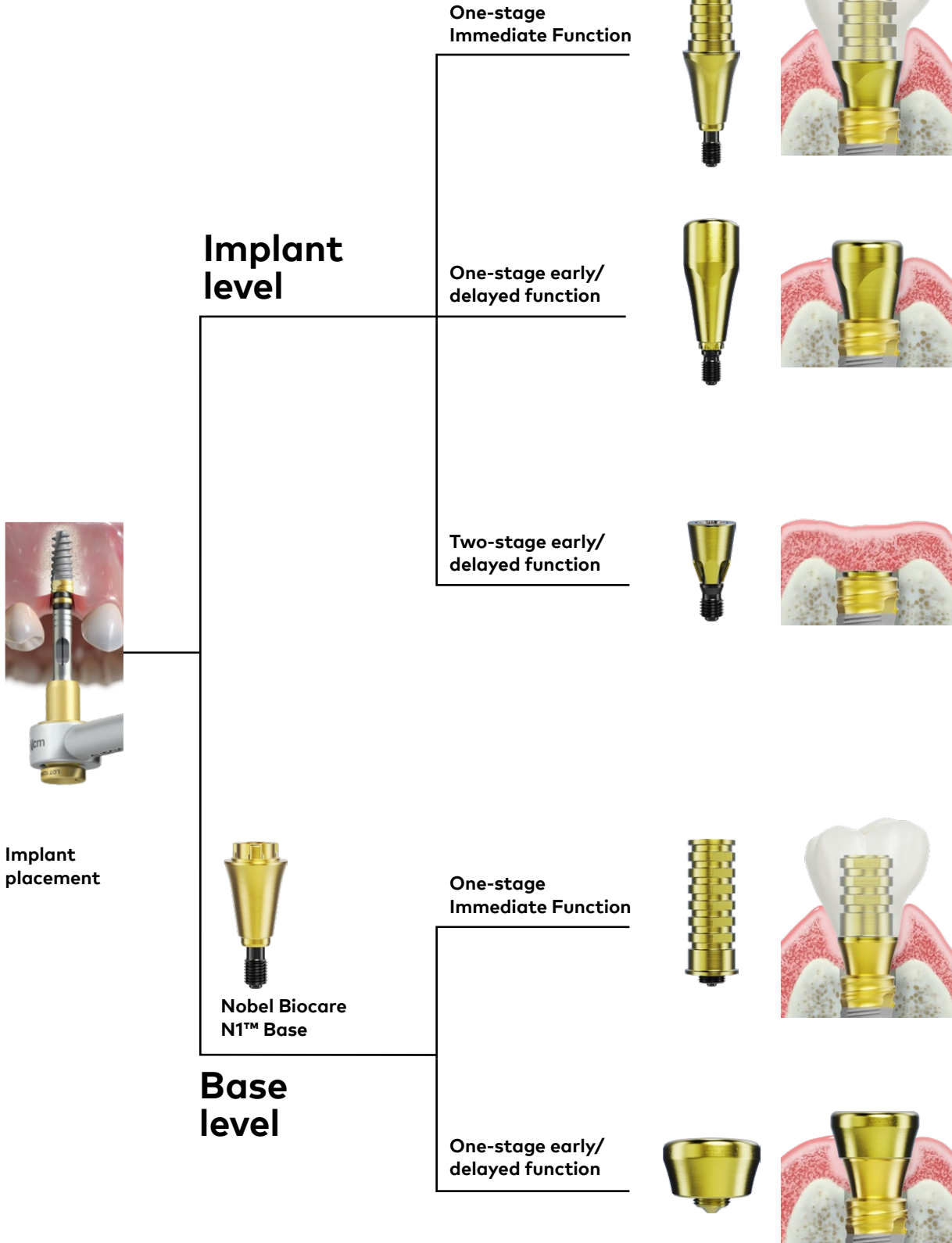

Temporary restorations

There are three options to temporarily restore an implant.



One-stage Immediate Function

Provisionalize the implant for immediate esthetics and function, using Nobel Biocare On1 Temporary Abutments or implant-level temporary abutments.

See more on [page 46](#)



One-stage early/delayed function

Place the On1 Base Xeal and connect the On1 Healing Cap to it. Or connect a healing abutment directly to the implant. If applicable, suture back the soft tissue.

See more on [page 50](#)



Two-stage early/delayed function

Connect a cover screw to the implant. Suture the tissue flap using the desired technique.

Note If the final restoration is an implant-level NobelProcera Implant Bridge, non-engaging Universal Abutment or non-engaging GoldAdapt Abutment, use a Healing Abutment Bridge to prevent tissue overgrowth on the horizontal implant platform.

One-stage Immediate Function

Temporary single-unit restoration

Temporary Abutments within the Nobel Biocare N1 system allow for immediate provisionalization at implant level and base level.

Single unit restorations

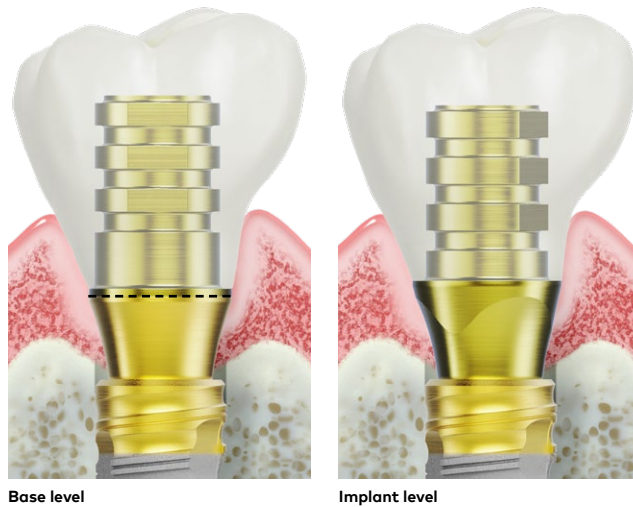

20
O-Mini

Multiple unit restorations



20
O-Mini

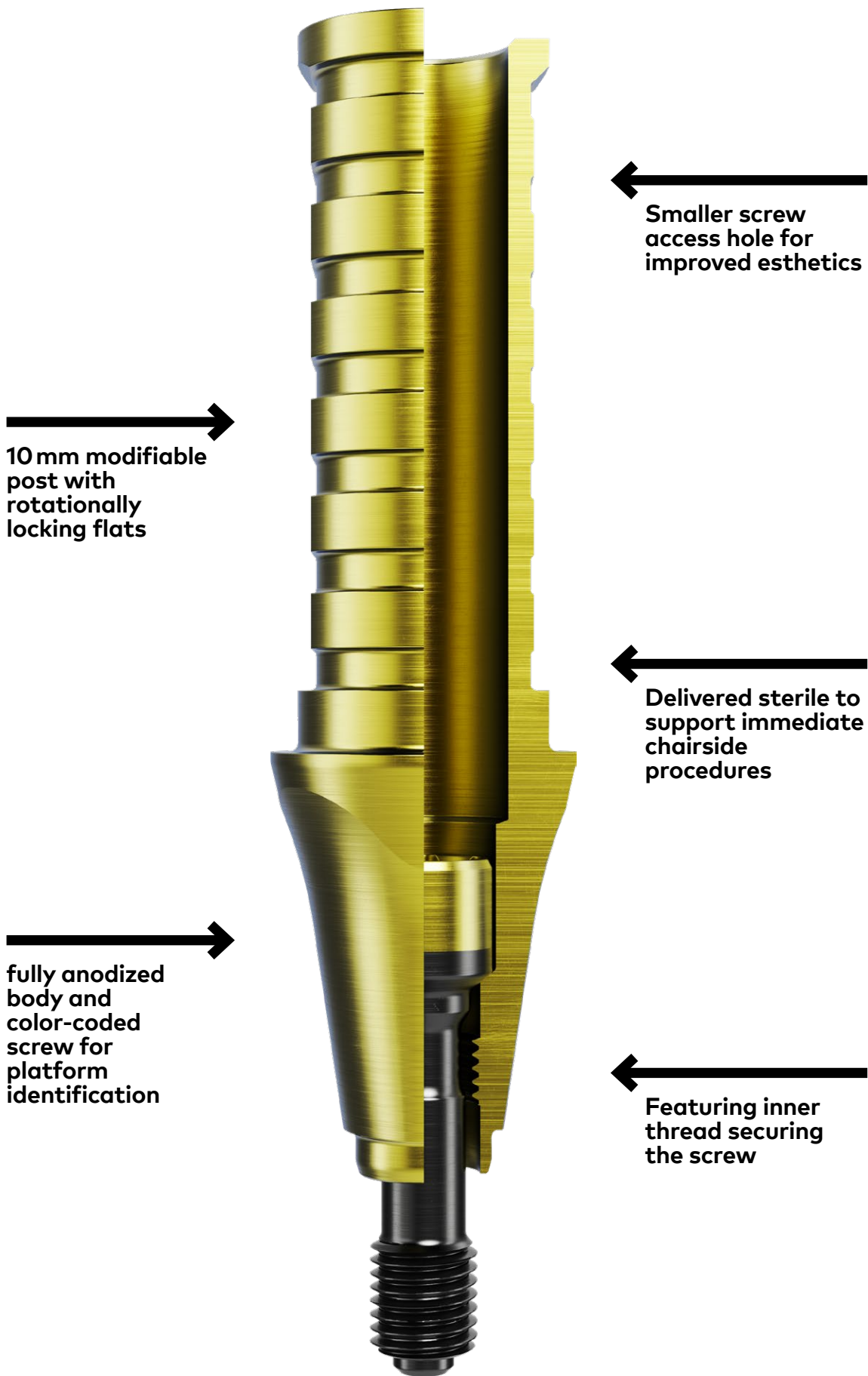

One-stage Immediate Function

Temporary single-unit restoration

The images demonstrate a procedure at base level as an example. The same steps apply to implant level workflow.

1 Connect temporary abutment

Connect the temporary abutment to the implant or base and hand-tighten it using the Omnigrip mini screwdriver.



2 Adjust post height

Check the post height for occlusal clearance. If it requires shortening, mark the desired height on the abutment post, then remove it from the patient's mouth and connect to a replica. Shorten the abutment using disc burr.

Do not modify the abutment seating area.



The post height after modification should be at least 4 mm.

3 Re-connect abutment

Re-connect the abutment to the implant or base and block the screw access hole using teflon tape.



4 Fabricate temporary restoration

- using TempShell
- using a pre-fabricated mold with suitable temporary restoration material
- using composite build-up technique

The macrodesign of the abutment post provides rotational and vertical locking of the crown.

5 Create screw channel

Open up a screw channel in the temporary crown in order to remove the abutment from the implant or base and connect it the implant replica.



6 Try-in restoration

Make final adjustments to the restoration. Try-in in the patient's mouth and adjust occlusal surface if needed.

Temporary restoration should be placed out of occlusion.



7 Tighten restoration

Tighten the temporary restoration to 20 Ncm using the clinical screw (co-packed with the abutment) and Omnigrip mini screwdriver.

Take an x-ray to verify the seating of the temporary restoration.



8 Block screw access hole

Block the screw access hole using suitable material (e.g. teflon tape), before closing it with composite.



One-stage early/delayed function

Healing Abutment

For cases where immediate provisionalization is not needed or not indicated - there is a portfolio of titanium/PEEK healing abutments and cover screws to choose from.

Healing abutment



Base level



Implant level



IOS healing abutment



Base level

Hand
O-Mini

Features

- Emergence profile harmonized with impression copings, temporary abutment and universal abutment
- Delivered sterile
- Three shapes available



The images demonstrate a procedure at implant level as an example. The same steps apply to base level workflow.

1 Select healing abutment

Select appropriate healing abutment and check the occlusal clearance.

2 Connect healing abutment

Connect the abutment to the implant or Nobel Bicoare N1 Base and hand-tighten using the Omnigrip mini screwdriver.



3 Block screw channel

The screw channel of the healing abutments may be blocked using Teflon tape and dental composite.



Removal

To remove the healing abutment, untighten it using the Omnigrip mini screwdriver.

Final restorations

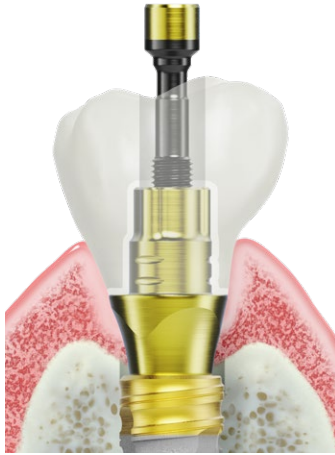

There are three options for finalizing the implant surgery.

Local production

Definitive screw-retained, cemented and individualized restoration solutions to be completed with an in-lab milled crown (fully anodized abutment, co-packed with color-coded screw).

See all the options on [page 54](#)



NobelProcera® restoration

Nobel Biocare offers ready-to-use CAD/CAM prosthetics, workflows, and services that maximize lab efficiency and save you time. 100% cement-free, screw retained restorations available for Nobel Biocare N1 system.

See all the options on [page 56](#)

**Smaller screw
access hole
for improved
esthetics**

**4 mm post
geometry
optimized for
in-lab milling
devices**

**Inner thread
securing the
screw**



**Supported by
DTX Studio™
and 3Shape**

**Fully anodized
abutment,
co-packed with
color-coded
screw**

Local production

Final screw-retained restorative solution to be completed with in-lab milled crown or bridge.

Universal Abutment Base is available in two versions: for single units and for bridges (lasermarked with B) of up to 20° divergence between implants.

Universal Abutment – Screw retained

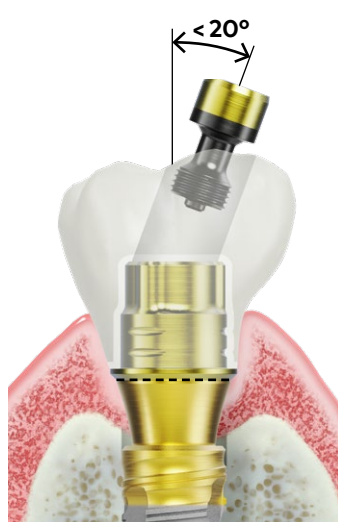

Single-unit



Partial bridge

20
O-Mini

Esthetic abutment – Cement retained

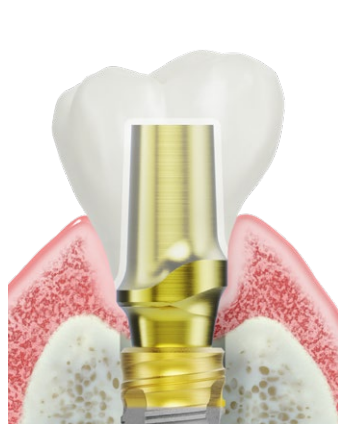

Single-unit



Partial bridge

20
O-Mini

Universal Base Multi-unit Abutment – Cement retained



Full-arch solution

15
O-Mini



15
Uni



NobelProcera® restoration

The NobelProcera components are a unified solution within the Nobel Biocare N1 system.

Used together, they provide a precise fit between abutment, implant and screw combined with quality manufacturing helps to avoid system or component failure.

NobelProcera Zirconia implant crown

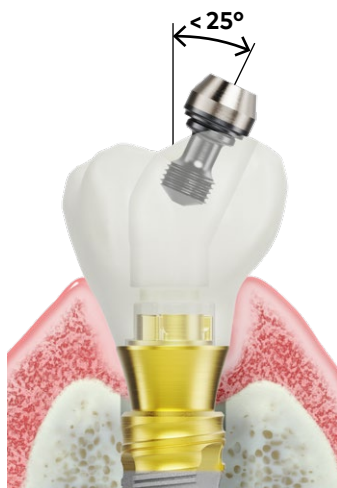

20
O-Mini

Single-unit on Nobel Biocare N1 Base

Features

- Angulated screw channel feature (0–25°)
- 10 VITA shades
- Three design options: abutment, cut-back, full-contour



Tightening torques for Multi-unit abutments

20
MUA



Multi-unit Abutment Xeal
Nobel Biocare N1 TCC

20
O-Mini



17°/30° Multi-unit Abutment Xeal
Nobel Biocare N1 TCC

Note Refer to the All-on-4 treatment concept handbook for detailed workflows about the Multi-unit Abutment.

NobelProcera Zirconia implant bridge



Partial bridge to full-arch solution

15
O-Mini

NobelProcera Titanium fixed implant bar



Partial bridge to full-arch solution

15
Uni

Impression techniques procedures

Dental impression transfers the position of the Nobel Biocare N1 Implant or Nobel Biocare N1 Base from the patient's mouth to the patient model, using impression copings or position locators.

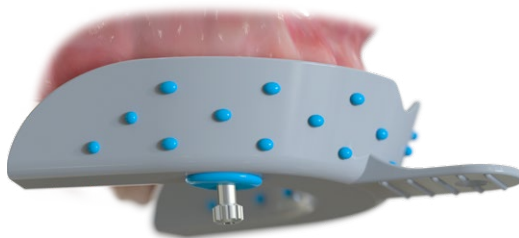

Open tray

Use the open tray technique:

- To avoid any potential risks associated with re-seating of the impression coping, when it is preferable to have the impression coping retained in the impression material
- When the lack of implant parallelism would make tray removal difficult using the closed tray technique
- When the height of the implant level impression coping is significantly below the occlusal plane

See procedure on [page 60](#)

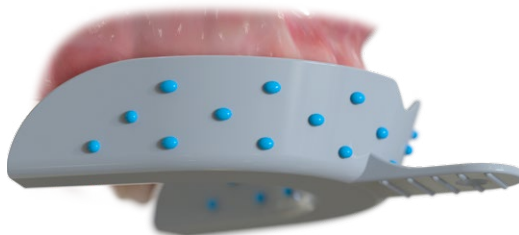

Closed tray

Use the closed tray technique:

- When it is possible to re-seat the impression coping optimally
- When the vertical height is limited
- When the implant parallelism is sufficient (it may be challenging to remove the impression without tearing the material if the implant divergence is greater than 15°)

See procedure on [page 62](#)

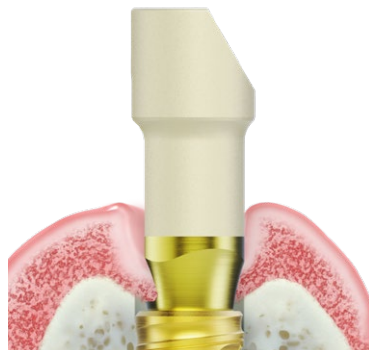

Digital

Both the Position Locators and IOS Healing Abutments within the Nobel Biocare N1 system can be used with Intra-oral scanners. In addition the Position Locators can be used also with desktop scanners in a dental laboratory.

Position Locators are reusable titanium scan bodies featuring Zirconium Nitride coating. The angulated screw channel access gives a large matching surface area. Position Locators do not require disassembly prior reprocessing.

See procedure on [page 64](#)

Conventional

The apical part of the impression coping is fixed to the implant or the base connection with a guide pin. The coronal part of the impression coping is designed prior to reprocessing in the dental impression material.

Closed tray impression coping



Base level

Implant level

Open tray impression coping

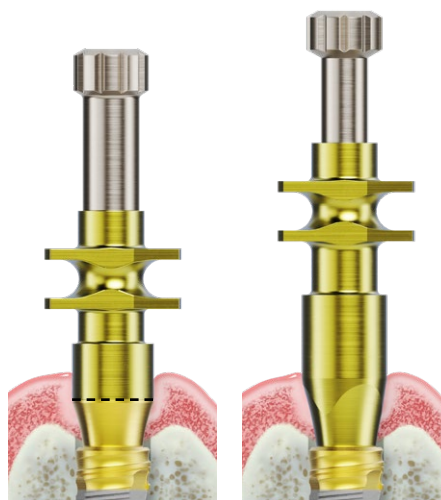

Base level

Implant level

Hand
O-Mini

The open tray impression copings are designed with retention elements resembling the trioval shape of the Nobel Biocare N1 implant and the Nobel Biocare N1 Base.

The impression coping is intended to be positioned with the wider retention element oriented buccally.

Note the orientation of the retention elements



Open tray technique

The images demonstrate a procedure at implant level as an example. The same steps apply to Nobel Biocare N1 Base Position Locators workflows.

1 Remove abutment

Remove the healing abutment, temporary abutment or cover screw from the implant or base using Omnigrip mini screwdriver by rotating it counterclockwise.

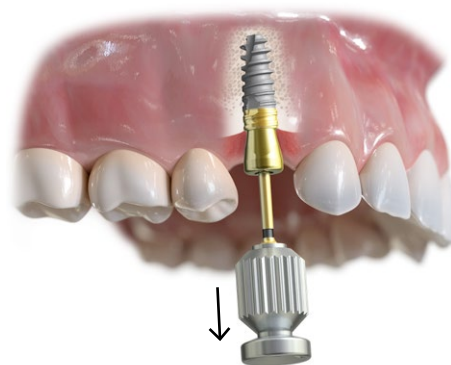

2 Connect Position Locator

Select the appropriate impression coping according to the implant or base connection and platform.

Connect the impression coping to the implant or base and hand-tighten the guide pin either by hand or by using the Omnigrip mini screwdriver.



3 Verify seating

Check that the impression coping is not in contact with adjacent teeth.

Take an x-ray to verify the seating of the impression coping before taking the impression.

4 Inject impression material

Inject impression material around the impression coping and into the tray and record the impression by seating the impression tray fully, so that the tip of the guide pin is identified.



5 Unscrew guide pin

After the impression material has set, unscrew the guide pin until it is disengaged from the implant or base using the Omnigrip mini screwdriver.

Caution Do not remove the guide pin from the embedded impression coping, as this might cause loss of the O-ring from the guide pin.

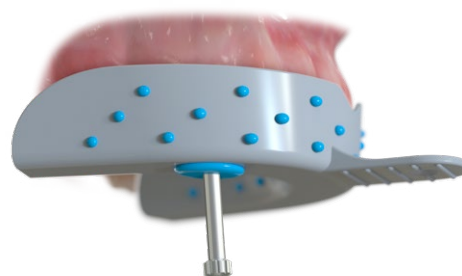

6 Remove tray

Remove the impression tray from the patient's mouth, keeping the impression coping and the guide pin embedded in the impression material, and check the impression for any irregularities or bubbles.

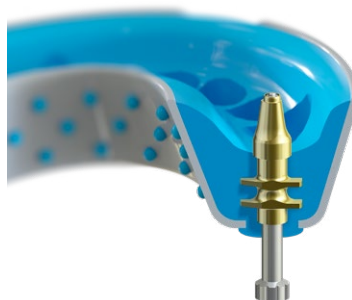

7 Re-connect abutment

Re-connect the healing abutment, temporary abutment or cover screw to the implant or base to prevent soft tissues from collapsing.

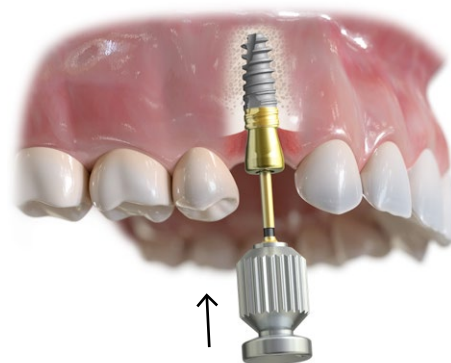

8 Send impression to lab

Send the disinfected impression to the dental laboratory.

Closed tray technique

The images demonstrate a procedure at implant level as an example. The same steps apply to Nobel Biocare N1 Base Position Locators workflows.

1 Remove abutment

Remove the healing abutment, temporary abutment or cover screw from the implant or base using the Omnigrip mini screwdriver by rotating it counterclockwise.

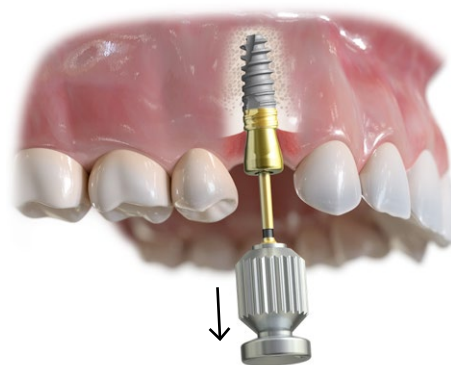

2 Connect Position Locator

Select the appropriate impression coping according to the implant or base connection and platform.

Connect the impression coping to the implant or base and hand tighten it using the Omnigrip mini screwdriver.

The impression copings should be hand-tightened only.

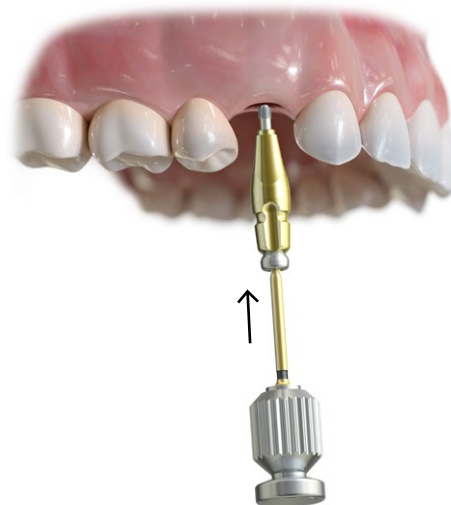

3 Verify seating

Take an x-ray to verify the seating of the impression coping before taking the impression.

4 Block driver indentation

Block out the Omnigrip mini driver indentation on the impression coping using wax.

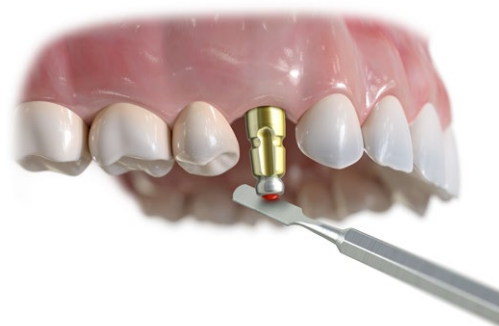

5 Inject impression material

Inject a medium or heavy body impression material around the impression coping and into the tray and record the impression by seating the tray.



6 Remove tray

Remove the tray as the impression material has set. Check the impression for any irregularities or bubbles. Remove the block-out material from the screw, if applicable.

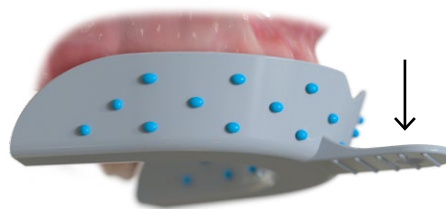

7 Remove impression coping

Untighten the impression coping from the implant or base using the Omnigrip mini screwdriver.

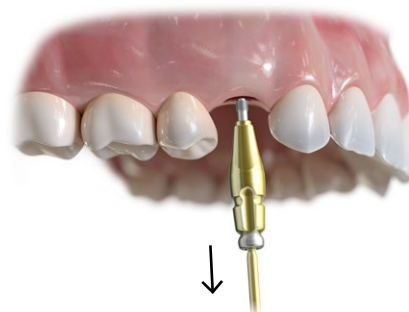

8 Re-connect abutment

Re-connect the healing abutment, temporary abutment or cover screw to the implant or base to prevent soft tissues from collapsing.



9 Send impression to lab

Send the disinfected impression to the dental laboratory.

Digital impression taking

Both the Position Locators and IOS Healing Abutments within the Nobel Biocare N1 system can be used with Intra-oral scanners. In addition the Position Locators can also be used also with desktop scanners in a dental laboratory.

Position Locators are reusable titanium scan bodies featuring Zirconium Nitride coating. The angulated screw channel access gives a large matching surface area. Position Locators do not require disassembly prior reprocessing.

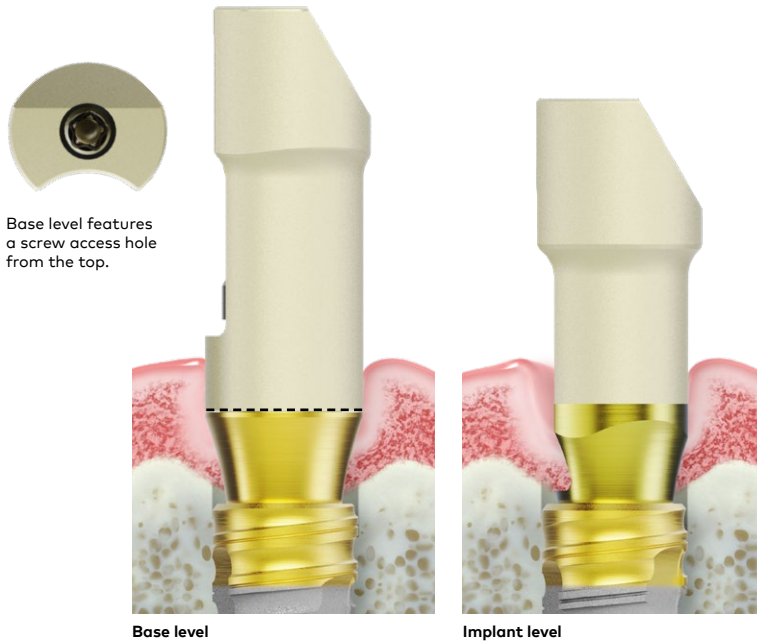

Position locator

Hand
O-Mini

IOS healing abutment



Hand
O-Mini

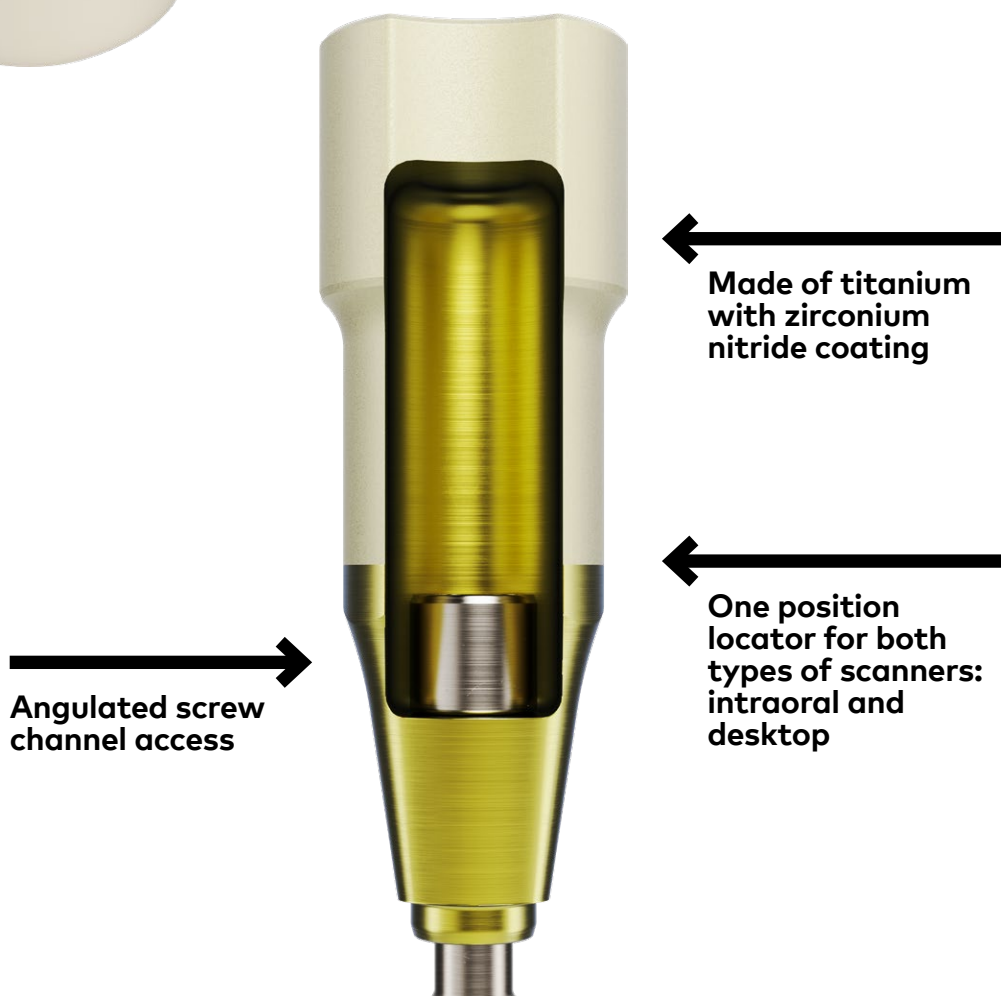
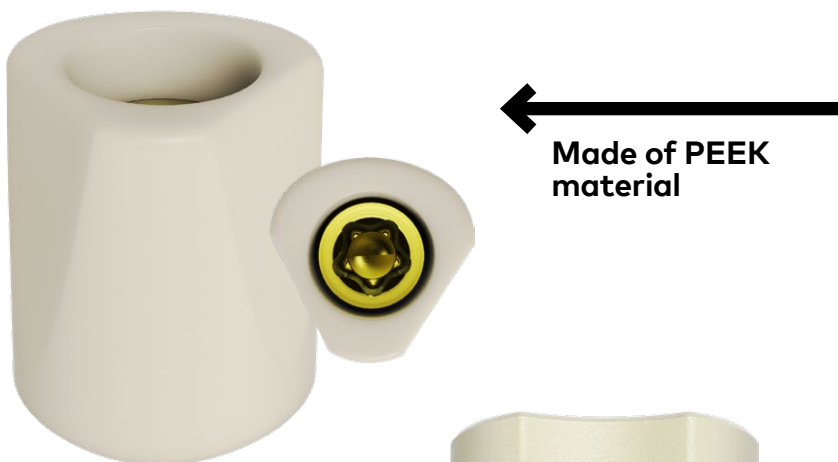
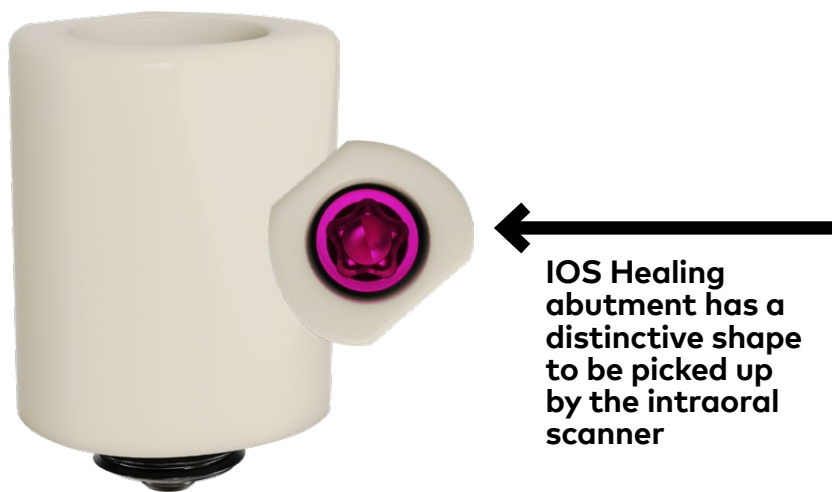

Digital impression taking with IOS

The images demonstrate a procedure at implant level as an example. The same steps apply to Nobel Biocare N1 Base Position Locators and N1 Base IOS healing abutments workflows.

1 Remove abutment

If applicable, remove the healing abutment, temporary abutment or cover screw from the implant or base using the Omnigrip mini screwdriver by rotating it counterclockwise.

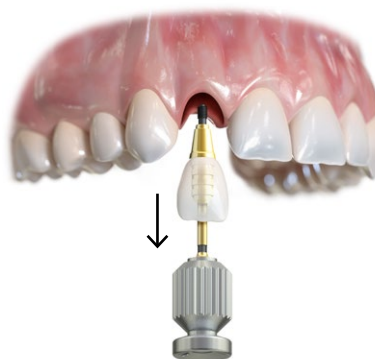

2 Connect Position Locator

Connect the Position Locator to the implant or base by hand-tightening the screw using the Omnigrip mini Screwdriver.

Orienting the Position Locator with the screw access opening towards the buccal side will give you better accessibility for the driver.

PEEK Healing Abutments are single-use components and need to be sterilized prior to usage.

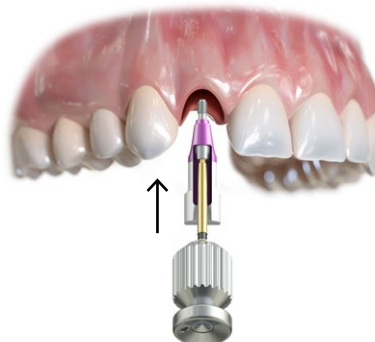

3 Verify seating

Take an x-ray to verify the seating of the Position Locator before taking the intraoral scan.

4 Perform intraoral scan

Take an intraoral scan of the patient, following the scanner manufacturer's instructions.

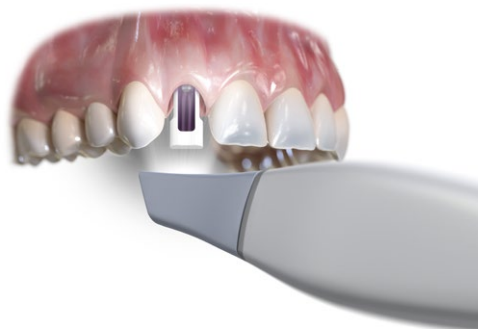

5 Remove Position Locator

Remove the Position Locator by untightening the screw.

If using the IOS Healing Abutment, leave the component in place for the healing phase.

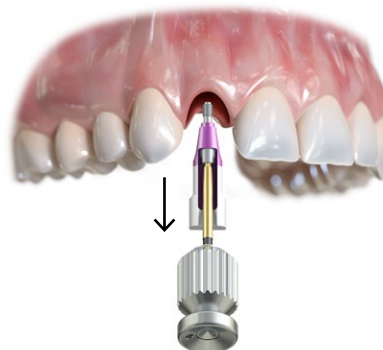

6 Reconnect abutment

Reconnect the healing abutment or the temporary restoration to prevent the soft tissue from collapsing.

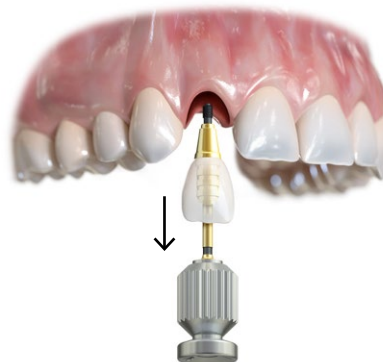

7 Send files to lab

Send the scan file to the dental laboratory. Provide them with the information about the position locator used. The options are:

Position Locator Nobel Biocare N1 TCC NP/RP

Position Locator Nobel Biocare N1 Base Tri NP/RP

IOS Healing Abutment Nobel Biocare N1 Base Tri NP/RP (PEEK)

8 Clean and sterilize the Position Locator

After intraoral use, clean and sterilize the Position Locator following the instructions in the Cleaning and Sterilization Instruction section.



▲ Torque Wrench

◆ Torque Wrench Internal

▼ Torque Wrench / Depth

Nobel Biocare N1 CE 2797

SINGLE USE ONLY

NTM

Osseo-Director™
< 2000 rpm
💧

Osseo-Shaper™ 1
50 rpm
< 40 Ncm
⚡

Osseo-Shaper™ 2
50 rpm
< 40 Ncm
⚡

Direction Indicator

Driver

Span

Omnigrip M

Impl Driver

Base

Extension

RP

Nobel Biocare

+1 mm

7+1

Instruments and kits

Surgical PureSet™ • 70

Prosthetic PureSet™ • 72

Surgical PureSet™

Nobel Biocare N1™
PureSet™ Tray
PUR0400

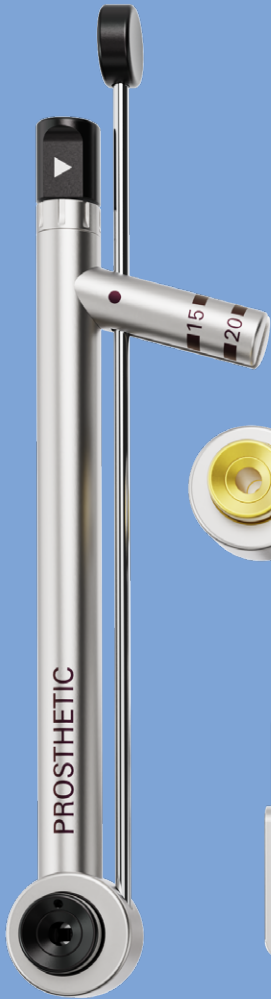

Torque Wrench
Prosthetic
301082

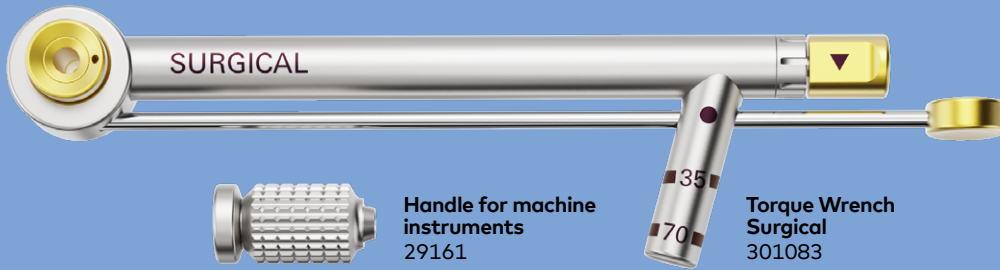

Torque Wrench
Surgical
301083

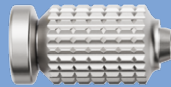

Handle for machine
instruments
29161



Depth Probe
300924

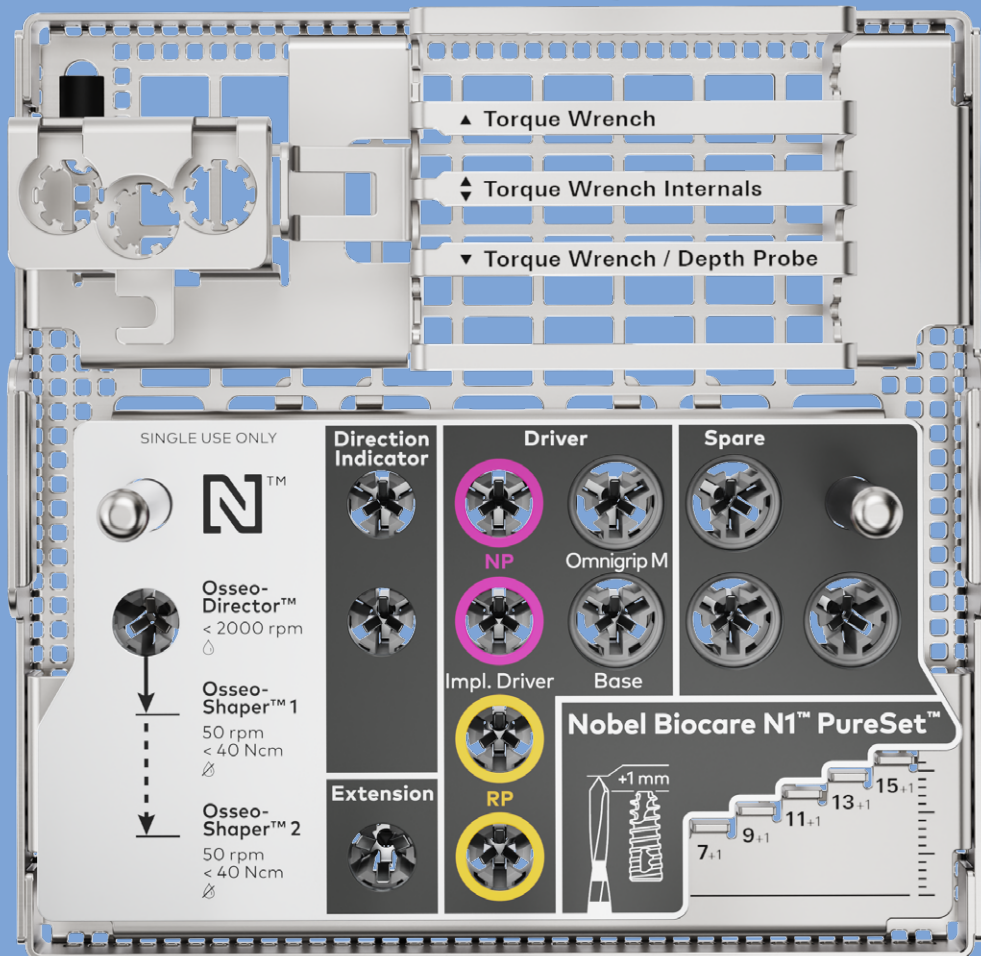

Omnigrip Mini
Machine
20mm 300852
28mm 300853
36mm 300854



Screwdriver
Machine Nobel
Biocare N1™ Base
28mm 300903
36mm 300904



OsseoDirector™
301077



Direction Indicator
300918



Extension
300923



Impl. Driver NP
short: 300905
long: 300906



Impl. Driver RP
short: 300907
long: 300908

Nobel Biocare N1™ PureSet™ surgical 87293

(The articles below can also be purchased individually)

Nobel Biocare N1™ PureSet Tray (include the plate)	PUR0400
Screwdriver Machine Nobel Biocare N1™ Base 28 mm	300903
Implant Driver Nobel Biocare N1™ TCC NP Short	300905
Implant Driver Nobel Biocare N1™ TCC NP Long	300906
Implant Driver Nobel Biocare N1™ TCC RP Short	300907
Implant Driver Nobel Biocare N1™ TCC RP Long	300908
Direction Indicator Nobel Biocare N1™ (2×)	300918
Screwdriver Machine Omnigrip™ Mini 28 mm	300853
Manual Torque Wrench Surgical Nobel Biocare N1™	301083
Handle for Machine Instruments	29161
OsseoShaper Extension Nobel Biocare N1™	300923
Depth Probe Nobel Biocare N1™	300924
Radiographic Template Nobel Biocare N1™	301074
Wall Chart Nobel Biocare N1™ PureSet	301075

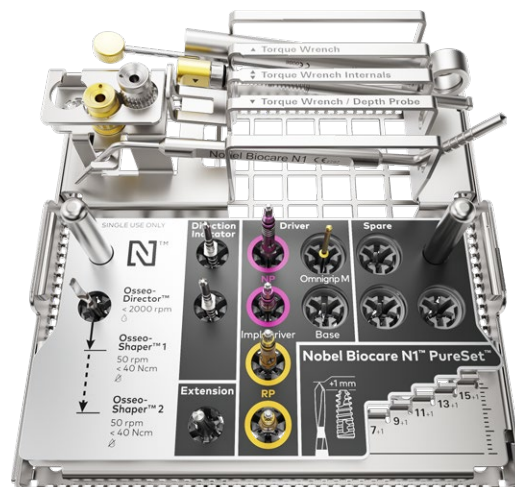

Bone Mill and Guide for TCC

(To be accommodated in the PureSet™)

Bone Mill Nobel Biocare N1™ TCC Ø 4.0	300909
Bone Mill Nobel Biocare N1™ TCC Ø 5.2	300910
Bone Mill Guide Nobel Biocare N1™ TCC NP Ø 4.0	300911
Bone Mill Guide Nobel Biocare N1™ TCC NP Ø 5.2	300915
Bone Mill Guide Nobel Biocare N1™ TCC RP Ø 5.2	300916



For more information regarding the product portfolio see the 'Product Overview - Nobel Biocare N1 system'.

Prosthetic PureSet™

Prosthetic PureSet™ Tray
PUR0500



Torque Wrench Prosthetic
29165

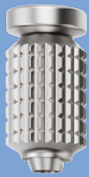

Handle for machine instruments
29161

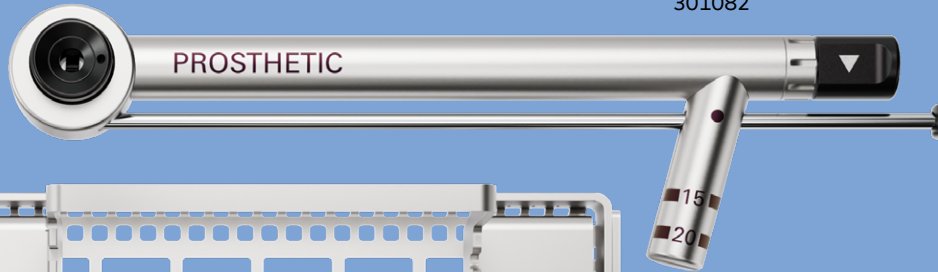

Torque Wrench Prosthetic
301082



▲ Torque Wrench
 ▲▼ Torque Wrench Internals
 ▼ Torque Wrench

Screwdriver Nobel Biocare N1™ Base

manual
28mm 301135
36mm 301136

machine
28mm 300903
36mm 300904

Multi-unit
manual 29156
machine 29158

Omnigrip Mini

manual
20mm 300855
36mm 300856

machine
20mm 300852
28mm 300853
36mm 300854

Omnigrip
 manual
 20mm 37376
 28mm 37377
 36mm 37378
 machine
 20mm 37379
 25mm 37380
 30mm 37381
 35mm 37382

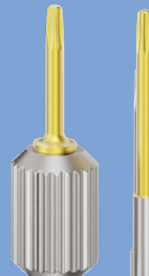
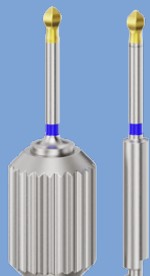

Unigrip
 manual
 20mm 29148
 28mm 29149
 36mm 29150
 machine
 20mm 29151
 25mm 29152
 30mm 29153
 35mm 29154

Prosthetic PureSet™**87353**

(The articles below can also be purchased individually)

Prosthetic PureSet Tray	PUR0500
Wall Chart Prosthetic PureSet	301076
Screwdriver Machine UniGrip 30 mm	29153
Screwdriver Machine Omnigrip mini 28 mm	300853
Screwdriver Machine Omnigrip 30 mm	37381
Screwdriver Machine Nobel Biocare N1 Base	300903
Screwdriver Machine Multi-unit 21 mm	29158
Handle for Machine Instruments	29161
Manual Torque Wrench Prosthetic	29165
Manual Torque Wrench Prosthetic Nobel Biocare N1	301082

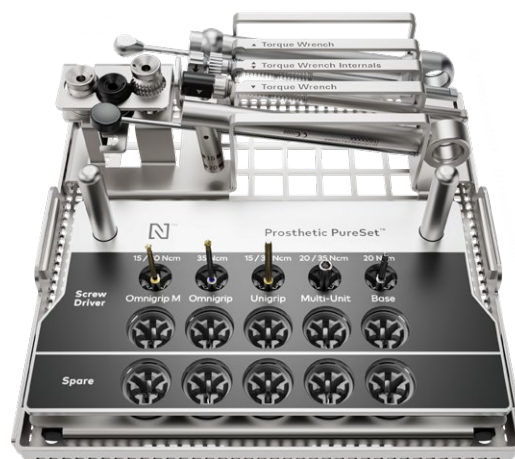

For more information regarding the product portfolio see the 'Product Overview - Nobel Biocare N1 system'.



Appendices

Manual Torque Wrench • 76

How to remove implant level abutments • 78

How to remove the Nobel Biocare N1™ Base • 80

Cleaning and sterilization • 82

Manual Torque Wrench

For the surgeon, the torque required to place implants provides insight into the primary stability of the implant. For restorative procedures, tightening the abutment and prosthetic screws to the recommended torque specifications will more effectively control screw-joint integrity during patient function.

Manual Torque Wrench – Surgical

Manual Torque Wrenches Surgical are indicated for use with Nobel Biocare dental implant drivers to ensure that the desired torque is achieved during implant placement. They are also indicated for use with implant retrieval instruments and abutment screw retrieval instruments. Manual Torque Wrenches Surgical can be used as an alternative to machine torque wrenches.

- Indicating torque values 35 Ncm and 70 Ncm
- Insert Implant Driver Nobel Biocare N1 TCC



Manual Torque Wrench – Prosthetic

Manual Torque Wrenches Prosthetic are indicated for use with Nobel Biocare abutments and abutment screws to ensure that the desired torque is achieved during placement or removal of the abutment or screw. Manual Torque Wrenches Prosthetic can be used as an alternative to machine torque wrenches.

- Indicating torque values 15 Ncm and 20 Ncm
- Insert the applicable driver



Use of the Manual Torque Wrench Surgical

To tighten an implant, adjust the direction indicator so that the arrow is pointing toward the level arm and rotate clockwise.



To loosen an implant, adjust the direction indicator so that the arrow is pointing away from the level arm, and rotate counterclockwise.



To change the direction, pull out the direction indicator (a), turn it 180 degrees (b) and release it (c).

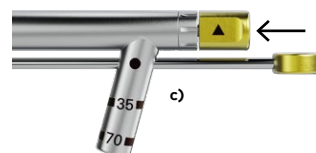
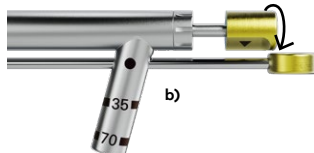
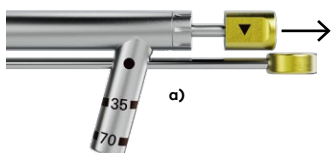

Warning If force is applied to the main body of the Manual Torque Wrench Surgical and not to the lever arm, the applied torque cannot be measured. High forces may cause over compression of the bone leading to bone resorption, especially in case of a thin buccal/lingual marginal bone crest.

After use, disassemble the Manual Torque Wrench by removing the adapter and the rod from the wrench body. Please follow the steps described in the IFU for Manual Torque Wrenches Surgical and Prosthetic.

How to remove implant level abutments

1 Unscrew clinical screw

Unscrew the Clinical Screw using Omnigrip Mini Screwdriver counterclockwise.



In some cases, the TCC abutment can be removed right after this step.

2 Re-connect screwdriver

Press the Omnigrip Mini Screwdriver into the screw to gain good retention.

3 Lift screw

To remove the screw, rotate the tool counterclockwise while gently lifting up.

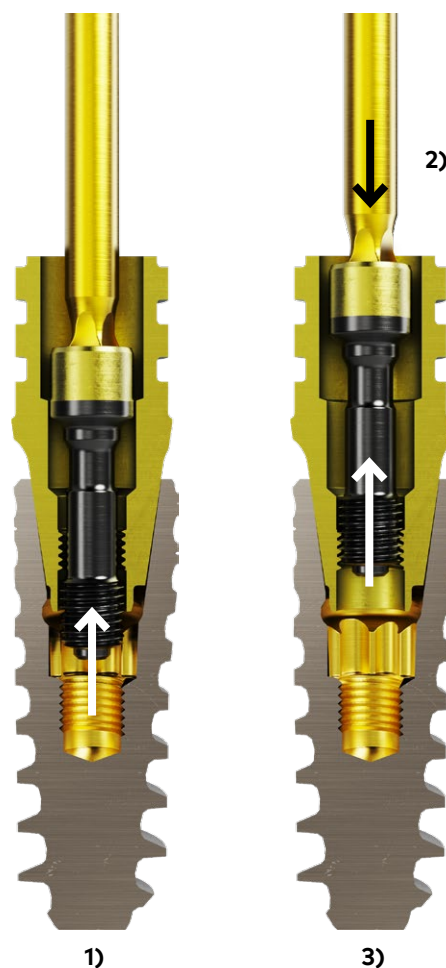

4 Engage retrieval tool

Engage the Abutment Retrieval Tool to the handle for machine instruments.



5 Insert instrument

Insert the instrument and disengage the abutment by turning clockwise. Remove the abutment.

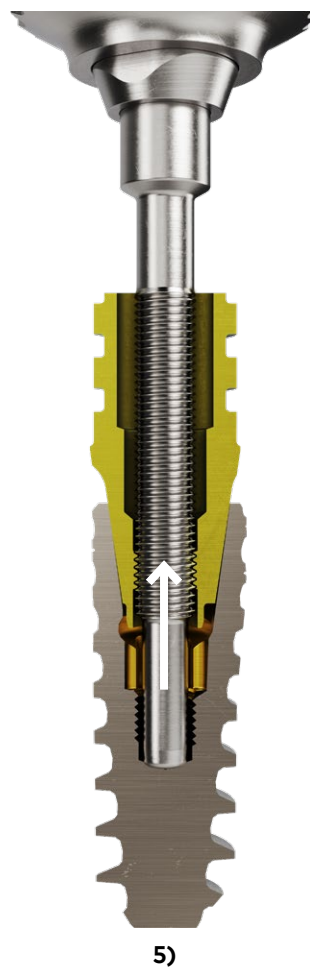

How to remove the Nobel Biocare N1™ Base

1 Unscrew clinical screw

Unscrew the Clinical Screw Nobel Biocare N1 Base using the Screwdriver Nobel Biocare N1 Base.



In some cases, the Nobel Biocare N1 Base can be removed right after this step.

2 Connect removal tool

Connect the Nobel Biocare N1 Base Screw Removal Tool to the handle for machine instruments, or use it free hand.



3 Engage removal tool

Engage the head of the clinical screw. Slightly rotating the tool while pushing can facilitate the engagement until you hear a "click".

4 Lift screw

To remove the screw, rotate the tool counterclockwise while gently lifting up.

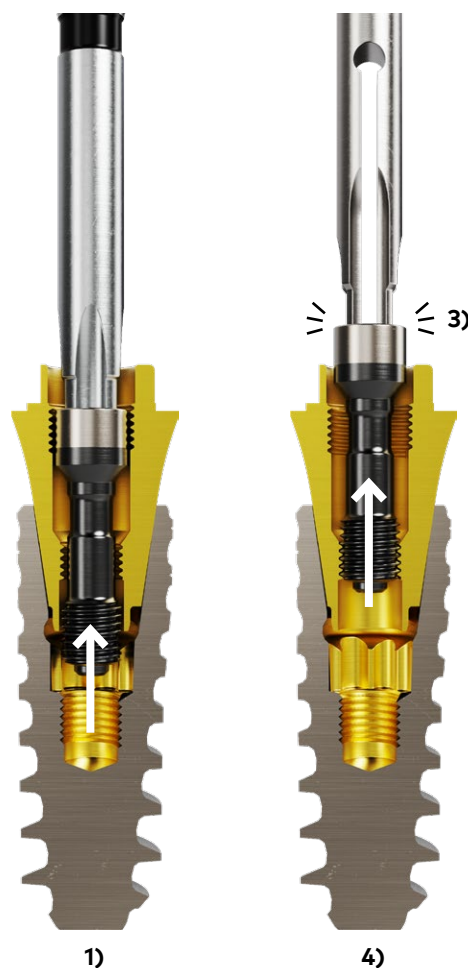

5 Engage retrieval tool

Engage the Abutment Retrieval Tool to the handle for machine instruments.



6 Insert instrument

Insert the instruments and disengage the abutment by turning clockwise. Remove the abutment.

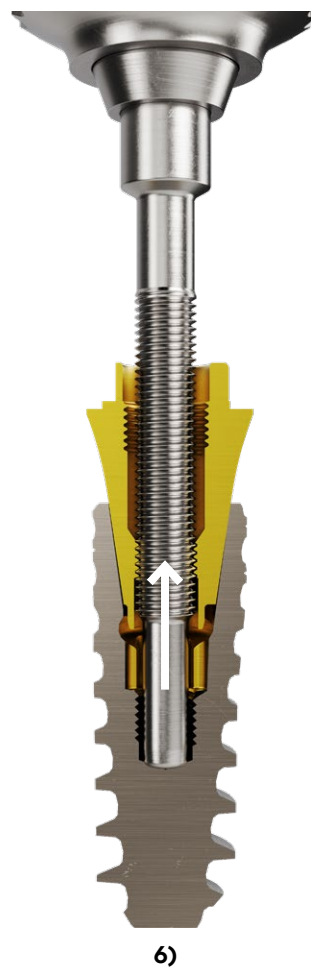

Cleaning and sterilization

Sterile components

Refer to the Instructions For Use (IFU1087) for Nobel Biocare N1 TiUltra TCC system for detailed cleaning and sterilization instructions.

ifu.nobelbiocare.com

Note Implants must never be resterilized or reused.



Implants

Caution Nobel Biocare N1 TiUltra TCC system are delivered sterile for single-use only. Do not use after the labeled expiration date.

Warning Do not use device if the packaging has been damaged or previously opened.

Warning Use of non-sterile device may lead to infection of tissues or infectious diseases.

Caution Nobel Biocare N1 TiUltra TCC system implants are a single-use product and must not be reprocessed. Reprocessing could cause loss of mechanical, chemical and/or biological characteristics. Reuse could cause local or systemic infection.



Drills

Delivered sterile and for single-use only:

- OsseoShaper 1
- OsseoShaper 2
- Precision drill
- Twist step drill



Non-sterile components

Caution Care and maintenance of sterile instruments are crucial for a successful treatment. Sterilized instruments not only safeguard your patients and staff against infection but are also essential for the outcome of the total treatment.

Refer to the Instructions For Use (IFU1067) for PureSet for detailed cleaning and sterilization instructions.

ifu.nobelbiocare.com

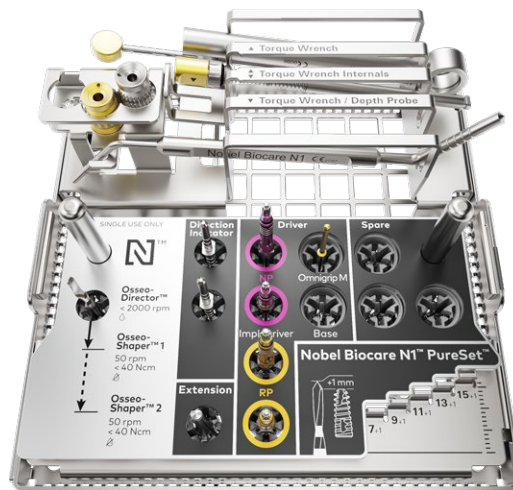

Abutments and plastic copings



Order online

Order our complete range of implants and prefabricated prosthetics 24 hours a day through the Nobel Biocare online store.

nobelbiocare.com/store

Order by phone

Call our customer service team or contact your sales representative.

nobelbiocare.com/contact

Lifetime warranty

The warranty covers all Nobel Biocare implants including prefabricated prosthetic components.

nobelbiocare.com/warranty



nobelbiocare.com/n1

