

Guided surgery

WE FOLLOW NO
ONE.

Contents

Introduction 5

- Treatment workflows 6
- Quick guide NobelActive® TiUltra™ 8
- Quick guide NobelParallel™ CC TiUltra™ 10
- Quick guide NobelReplace® CC TiUltra™ 12

Diagnostics and treatment planning 15

- Clinical examination and data acquisition 16
- Preparation of radiographic guide (edentulous cases only) 22
- Radiographic guide for edentulous jaw 24
- Fabrication of a new edentulous radiographic guide 26
- Digitization 30
- Dental cast and diagnostic setup 34
- Tooth extraction using a dental cast (partially edentulous cases) 36

Important considerations before surgery 39

- Surgical template 40
- Fabrication of stone model and surgical index 46
- Checklist before surgery 53

The scope of this surgical procedures manual is to provide a comprehensive overview of the surgical steps. This surgical procedures manual does not replace the Instructions For Use (IFU). Please review

the Instructions For Use, including Indications For Use, Contraindications, Warnings and Cautions before using the products. Instructions for Use are available at:
ifu.nobelbiocare.com

For a full list of article numbers and for ordering information, contact a Nobel Biocare representative.

Surgical procedure 55

- Anchoring the surgical template 56
- Guided pilot drilling procedures 58
- Implant insertion 63
- Special drilling considerations for NobelActive® TiUltra™ 3.0 68
- Fully guided drilling procedures 70
- Common drilling considerations 73
- Wallchart NobelActive® Guided PureSet™ 78
- Wallchart NobelParallel™ CC Guided PureSet™ 80
- Wallchart NobelReplace® CC Guided PureSet™ 82
- Guided drilling and implant placement NobelActive® TiUltra™ 87
- Guided drilling and implant placement NobelParallel™ CC TiUltra™ 99
- Guided drilling and implant placement NobelReplace® CC TiUltra™ 110

Prosthetic procedure 123

- Temporization 124

Appendices 131

- Manual Torque Wrench 132
- Guided Anchor Pins 134
- Calibration procedure for radiographic guide 136
- CT Protocols 137
- Cleaning and sterilization 138

Note In order to improve readability, Nobel Biocare does not use ™ or ® in the running text. By doing so, however, Nobel Biocare does not waive any right to the trademark or registered mark and nothing herein shall be construed to the contrary.

Disclaimer Some products may not be regulatory cleared, released or licensed for sale in all markets. Please contact the local Nobel Biocare sales office for current product assortment and availability.

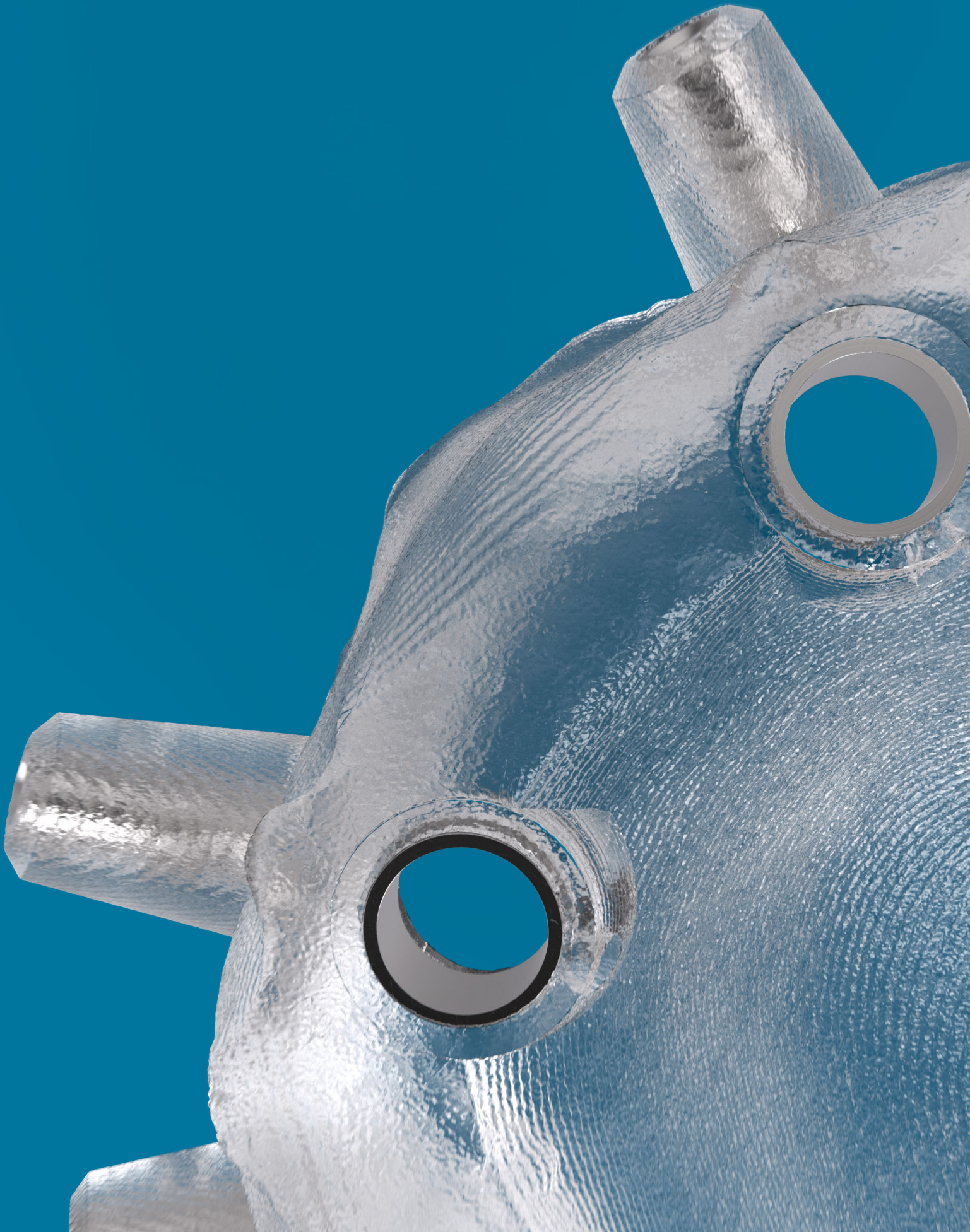

Introduction

Treatment workflows 6

Quick guide NobelActive® TiUltra™ 8

Quick guide NobelParallel™ CC TiUltra™ 10

Quick guide NobelReplace® CC TiUltra™ 12

Treatment workflows

Every case is different. To optimize the outcome, two treatment workflows are available.

The NobelGuide treatment workflow for the partially edentulous patient allows the clinician the flexibility of taking a (CB)CT scan of the patient at any time during the initial examination. Following preliminary diagnostics and treatment planning, the decision can be made to later, at any time, add more information such as surface data using an intraoral scanner or to take an impression and scan the dental cast (including a diagnostic setup if applicable).

For edentulous patients, the treatment workflow needs an additional step at the beginning to include the diagnostic tooth setup and its transformation into a radiographic guide. A (CB)CT scan of the patient and the radiographic guide is taken following the double-scan protocol.

With the data added in DTX Studio Implant, the clinician can visualize important intraoral information such as the soft tissue contour and thickness, and finalize the treatment plan according to the desired prosthetic outcome. Once the treatment plan is finalized the clinician has the option to go straight to surgery or to order a surgical template for either pilot drilling only or for fully guided drilling and, if applicable, guided implant placement.

Clinical examination

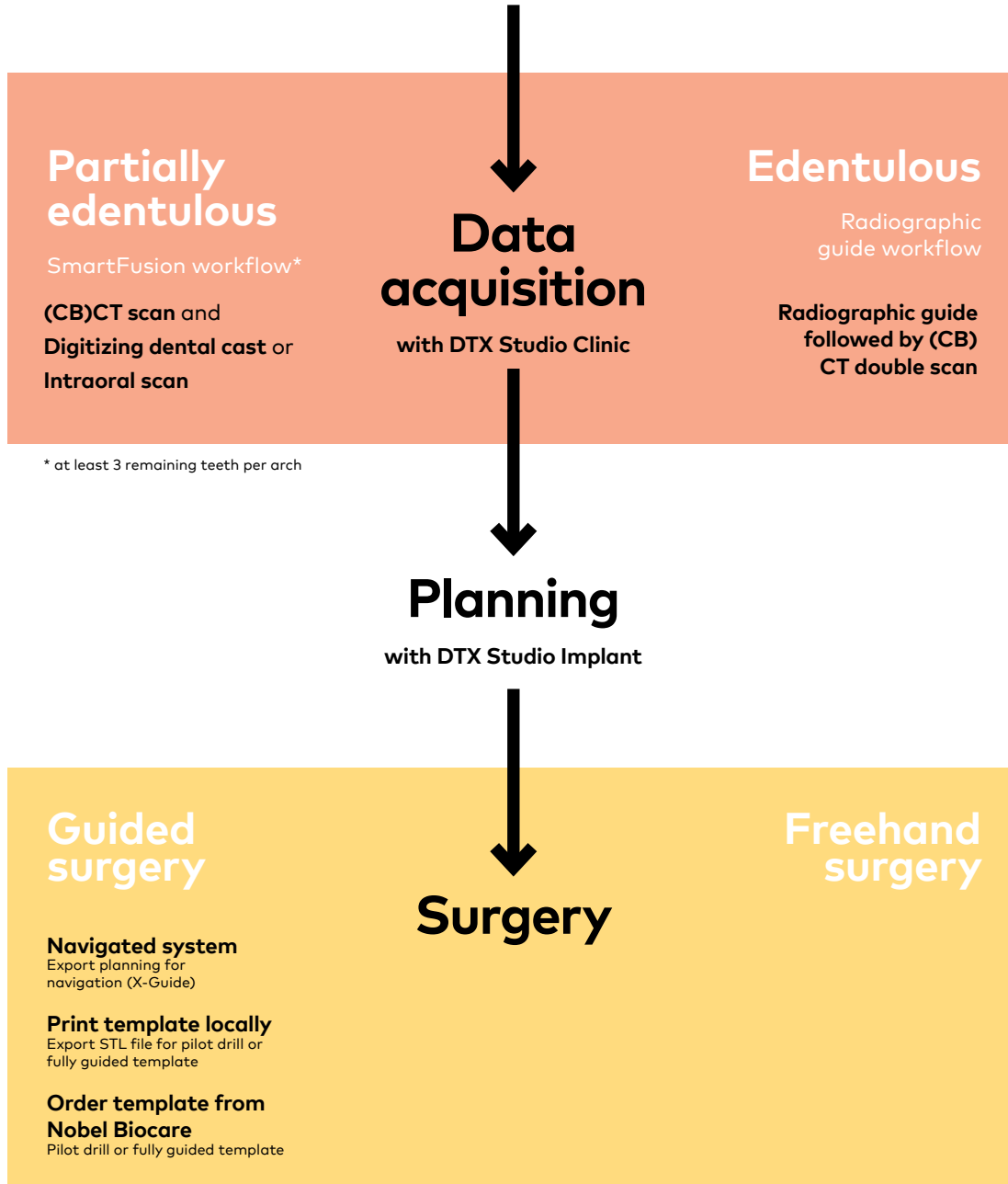

Quick guide NobelActive® TiUltra™

Guided pilot
drilling and
freehand

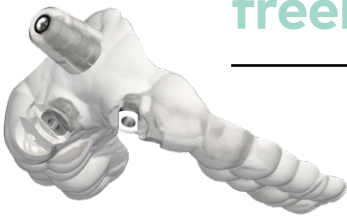

Fully
guided

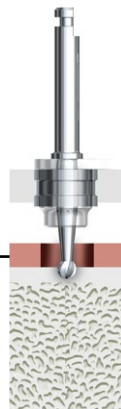

Mark drill position
(if indicated)
Guided Start Drill



Guided drilling
Guided Twist
Drill Ø 2.0



Depth reference
Depth Probe

OR



Depth reference
Twist Drill Ø 2.0

Note The illustrations show the drill sequence for NobelActive TiUltra RP 4.3 in medium bone. For other implant diameters and bone densities, see drill protocols on [page 89](#).

Full drill protocol on [page 89](#).



Drilling
Twist Step
Drill 2.4/2.8



Drilling
Twist Step
Drill 3.2/3.6



Implant placement
Implant Driver CC RP



Guided drilling
Guided Twist Step
Drill 2.4/2.8



Guided drilling
Guided Twist
Step Drill 3.2/3.6



Screw tapping
(Mandatory)
Guided Screw
Tap RP 4.3



Implant placement
Guided Implant Mount
NobelActive RP 4.3

Quick guide NobelParallel™ CC TiUltra™

Guided pilot
drilling and
freehand

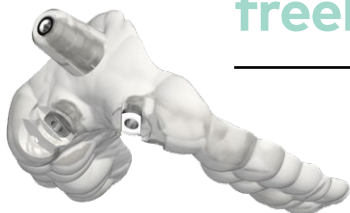

Fully
guided

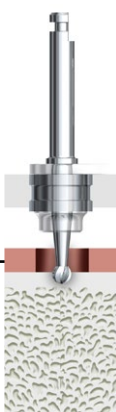

Mark drill position
(if indicated)
Guided Start Drill



Guided drilling
Guided Twist
Drill Ø 2.0



Depth reference
Depth Probe

OR



Depth reference
Twist Drill Ø 2.0

Note The illustrations show the drill sequence for NobelParallel CC TiUltra RP 4.3 in medium bone. For other implant diameters and bone densities, see drill protocols on [page 101](#).

Full drill protocol on [page 101](#).



Drilling
Twist Step
Drill 2.4/2.8



Drilling
Twist Step
Drill 3.2/3.6



Cortex widening
(medium/dense)
Cortical Drill 4.3



Screw tapping
(medium/dense)
Screw Tap CC 4.3



Implant placement
Implant Driver CC RP



Guided drilling
Guided Twist Step
Drill 2.4/2.8



Guided drilling
Guided Twist
Step Drill 3.2/3.6



Countersinking
(medium/dense)
Guided Counterbore
CC 4.3



Screw tapping
(medium/dense)
Guided Screw
Tap CC 4.3



Implant placement
Guided Implant
Mount CC RP

Quick guide NobelReplace[®] CC TiUltra[™]

Guided pilot
drilling and
freehand

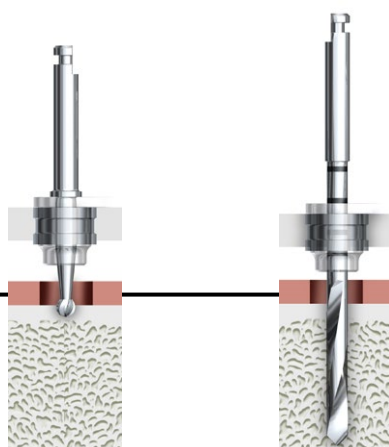
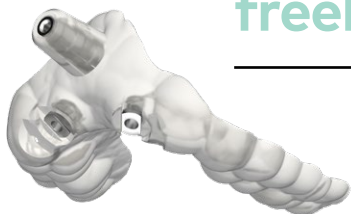

Mark drill position
(if indicated)
Guided Start Drill

Guided drilling
Guided Twist
Drill Ø 2.0

Fully
guided



Note The illustrations show the drill sequence for NobelReplace CC TiUltra RP 4.3 in medium bone. For other implant diameters and bone densities, see drill protocols on [page 111](#).

Full drill protocol on [page 111](#).

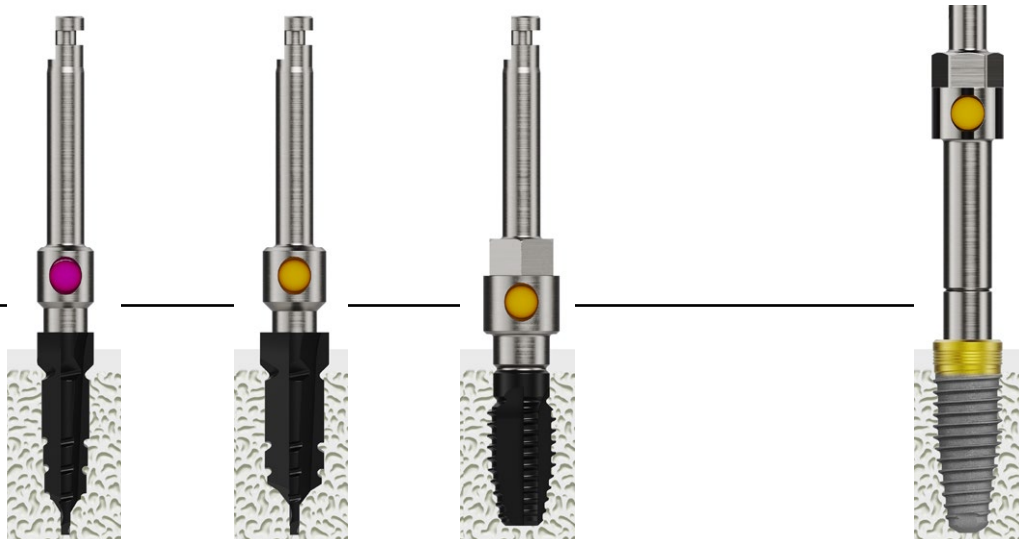

Tapered Drill
NP x 13 mm

Tapered Drill
RP x 13 mm

Screw Tap
RP

Implant placement
Implant Driver CC RP

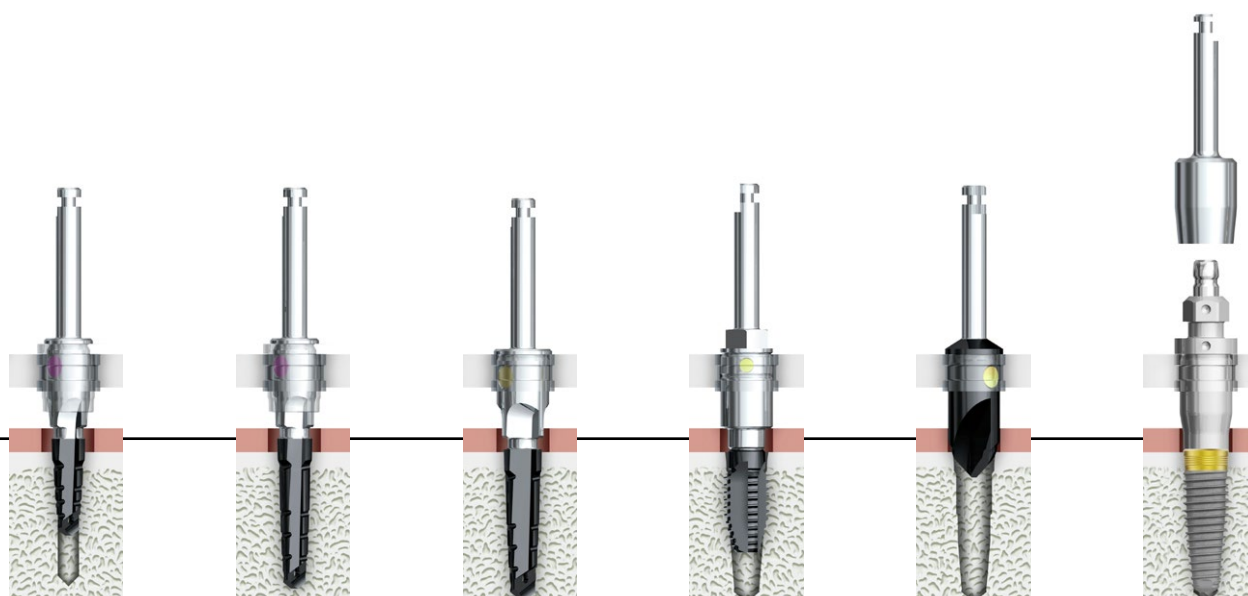

Guided Tapered
Drill NP x 8 mm

Guided Tapered
Drill NP x 13 mm

Guided Tapered
Drill RP x 13 mm

Guided Screw
Tap RP

Guided Cortical
Drill RP

Implant placement
Guided Implant
Mount CC RP

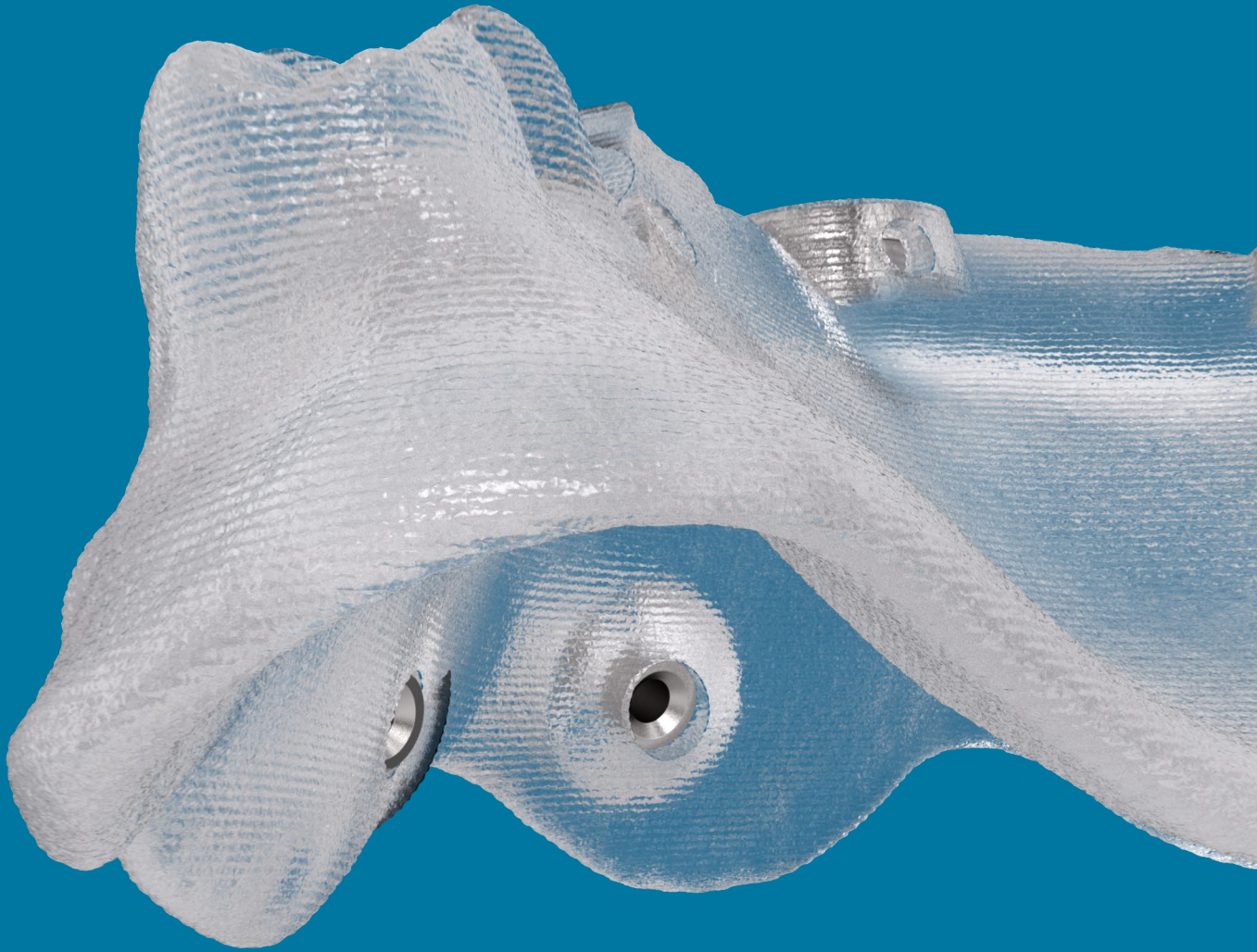

Diagnosics and treatment planning

Clinical examination and data acquisition	16
Preparation of radiographic guide (edentulous cases only)	22
Radiographic guide for edentulous jaw	24
Fabrication of a new edentulous radiographic guide	26
Digitization	30
Dental cast and diagnostic setup	34
Tooth extraction using a dental cast (partially edentulous cases)	36

Clinical examination and data acquisition

The indication for a medical procedure must be established by the responsible clinician. This decision relies on essential findings from the entire interdisciplinary treatment team. Careful initial clinical diagnostics, including systematic and dental considerations, are the basis for proper indication setting.

System evaluation

- Age, general health
- Immune status including diabetes
- Smoking

Clinical evaluation

- Radiographic diagnostics
- Caries activity
- Presence of periodontal disease
- Control of diseases prior to treatment
- Patient cooperation including oral hygiene

Dental examination

- Functional status (maximum intercuspation, centric relation, occlusal interferences, anterior guidance)
- Indications for parafunction
- Inter-arch relations (prosthetic considerations)
- Esthetics
- Tissue health, attached keratinized tissue
- Clinical evaluation for edentulous space (visual/palpation)
- Diagnostic models, diagnostic wax-up

For edentulous cases

1 Assess tissue stability

All sites must be fully healed following extractions or bone grafting procedures to ensure stable surgical template support reference.

Note Extraction and immediate implant placement of a single tooth is supported. For further details please refer to [page 36](#).

2 Assess mouth opening

A minimum mouth opening of 40 mm at implant sites is required to accommodate guided surgery tooling.

3 Assess patient smile line

Evaluate the transition zone and verify with the intended treatment (fixed or fixed-removable final prosthetic solution).

4 Evaluate intraoral soft tissue

Assess the quality and quantity of soft tissue.

Tip Consider (mini-)flap elevation as an alternative to punching in situations with reduced or minimal attached keratinized tissue.

5 Bite registration

Take full extended, definitive impressions of both jaws for study models.

Tips

- The impression quality must meet requirements of a definitive impression for the intended treatment.
- Record an accurate bite registration using registration plates or clinical bite index.

For partially edentulous cases

1 Assess tissue stability

All sites must be fully healed following extractions or bone grafting procedures to ensure stable surgical template support reference.

Note Extraction and immediate implant placement of a single tooth is supported. For further details please refer to [page 36](#).

2 Assess mouth opening

A minimum mouth opening of 40 mm at implant sites is required to accommodate guided surgery tooling.

3 Assess patient smile line

Evaluate the transition zone and verify with the intended treatment (fixed or fixed-removable final prosthetic solution).

4 Evaluate intraoral soft tissue

Assess the quality and quantity of soft tissue.

Tip Consider (mini-)flap elevation as an alternative to punching in situations with reduced or minimal attached keratinized tissue.

5 Bite registration

- Take a (CB)CT scan of the patient.
- Separate the jaws slightly using a wax plate or small wooden spatula taking care not to distort the facial anatomy.
- Preliminary diagnostics and treatment planning can be done in DTX Studio Clinic or DTX Studio Implant to determine treatment options.

Note See 'Digitization' on [page 30](#) for more details.

6 Get surface scan data

a) Take scan

- Use an intraoral scan device to acquire surface scan data.
- Make sure to get a high quality of the surface scan.



b) Take impressions and order dental cast scan

- Take fully extended, definitive impressions of both jaws for dental cast and diagnostic setup.
- The impression quality must meet requirements of a definitive impression for the intended treatment.
- Record an accurate bite registration using registration plates or clinical bite index material.
- Impressions are then sent to a lab to digitize the information.
- Order the digitized scan of the dental cast and diagnostic setup from the lab in the DTX Studio Implant software.
- The request is sent via NobelConnect. Print order request from DTX Studio Implant to include with impression when sent to the dental lab.



Note See 'Dental cast and diagnostic setup' on [page 34](#) for more details. For details on how to place the order, please refer to the DTX Studio Implant software Instructions For Use.

7 SmartFusion technology

Download or import the surface scan data and potentially the diagnostic setup into DTX Studio Implant and align to (CB)CT data using the SmartFusion technology. Check carefully if the alignment is correct.

Tip In case of doubt, contact your Nobel Biocare local technical support.

8 SmartSetup technology

SmartSetup is the solution to automatically calculate virtual teeth based on a scan of the current dental situation. The calculation takes several things into account such as the size, shape and position of the existing teeth. Different settings can be applied as well as edits done on the calculated SmartSetup. If a diagnostic setup was ordered from the lab, this can be used alternatively.

9 Finalize treatment plan

Finalize (prosthetic-driven) treatment plan and select surgery type (freehand, pilot drilling or fully guided) for each implant. Order surgical template, if applicable.

10 Treatment plan report

- Print the treatment plan report, regardless of chosen surgery method.
- The treatment plan report contains the details of the planned implant dimensions per implant site.

11 Surgery

For surgical template assisted surgery, the NobelGuide surgical guidelines or treatment plan report contains not only the planning details but the guided drill depths per implant site.

Note See DTX Studio Implant Instructions For Use for more details.

Preparation of radiographic guide (edentulous cases only)

Prosthetic-driven planning

The radiographic guide (a) is used to simulate the intended tooth setup and soft tissue surface during the (CB)CT scan for later reference during digital diagnostics. This simulation enables prosthetic-driven planning (b).

A correct design of the radiographic guide is a prerequisite for a successful treatment. The intended outcome of the restoration is defined, evaluated and represented through the radiographic guide.

The radiographic guide is also the basis for the surgical template (c). It is important to meticulously check the intimate fit with the soft tissue and remaining teeth.

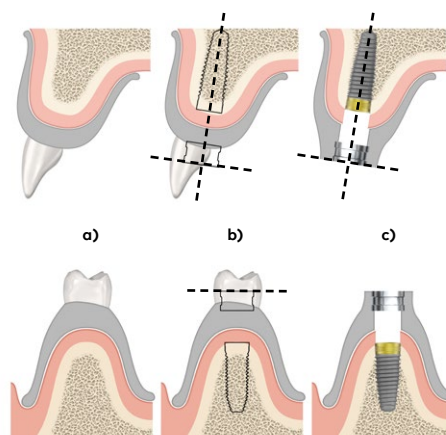

Design requirements

1 Ensure minimum thickness

- Design radiographic guide to have a minimum thickness of 2.5–3 mm of material in all areas.
- Ensure tooth anatomy is intact in areas to be restored.
- Ensure intimate fit with the supporting soft tissue and/or remaining teeth.

Tips

- The surgical template will reflect the same dimensions as the digitized 3D radiographic guide in the software.
- Consider the optimal tooth setup in terms of final tooth size and shape, position, occlusion, vertical dimension, esthetics, phonetics and lip support.
- The clinical try-in should mimic the design of the final restoration.

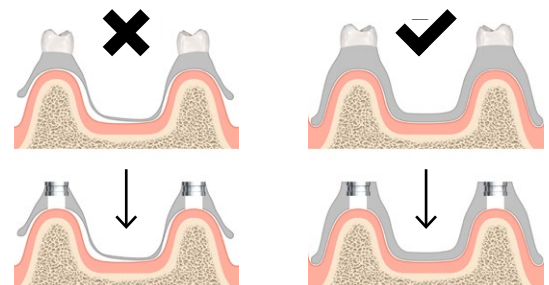
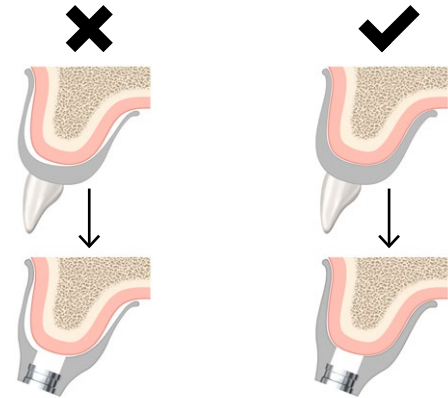

2 Check for proper fit

- Extend the radiographic guide over the entire dental arch and back to the retro-molar area.
- Ensure optimal fit according to anatomy, including:
 - Palate (if applicable).
 - Gingiva and/or mucosa, including vestibular extension for optimum retention (stability reasons) and for placement of anchor pins to secure the surgical template.

The existing prosthesis can be used as long as it represents the intended tooth setup, is optimized for intimate soft tissue contact (use a hard-underlining material of the same radiolucent properties as for the prosthesis) and is without metallic parts. However, it is recommended to fabricate a new radiographic guide based on a clinically validated tooth setup.



Radiographic guide for edentulous jaw

Existing prosthesis

The existing, optimized prosthesis can be used as long as it:

- represents the intended tooth setup for planning.
- is optimized for intimate soft tissue contact (only use a hard underlining material with the same radiolucent properties as the prosthesis).
- contains no radio-opaque parts i.e., metal framework, mesh palate, metal attachments, etc.

However, it is recommended to start from a new clinically validated tooth setup and create a new radiographic guide using PMMA material.

1 Place radiographic markers

To facilitate the (CB)CT double-scan protocol and enable the subsequent correct matching of the two scans in the DTX Studio Implant software, six–eight spherical reference points must be incorporated into the radiographic guide.

- Plan marker positions with an even spread on the lingual/palatal and buccal/labial regions using a felt marker.
- Ensure markers are placed above the gingival plane in the maxilla and below the gingival plane in the mandible.
- Distribute markers as asymmetrically as possible, ensuring that they will not end up in the same (CB) CT planes (increases accuracy of registration).
- Use a rose head bur to carefully make marker holes.
- Create spherical holes 1mm deep and with a 1–1.5 mm diameter.
- Fill holes with a radio-opaque material (preferred material is gutta percha).

Tips

- Check compatibility of material for markers with your (CB)CT scanner (manufacturer, model and firmware version as well as scan protocols) as some devices require less radio-opaque materials than gutta percha. Contact Nobel Biocare Technical Helpdesk for clarification.
- Avoid placing all markers in the same "axial" CT plane. Distribute across several planes.
- Ensure markers are placed randomly and well-distributed above the gingival plane.
- Avoid making the holes larger than indicated (larger volumes of gutta percha might cause artifacts and hamper the alignment process. As a rule of thumb, the spherical marker should be three times as big as the voxel size used for scanning).
- Avoid perforation of the radiographic guide with the markers.

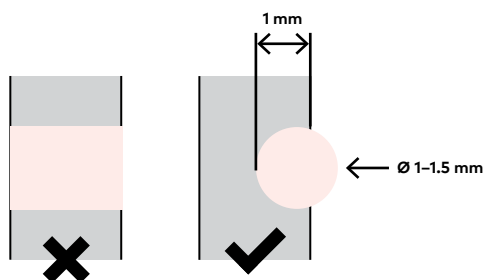

Existing, optimized prosthesis with radiographic markers

2 Make radiographic index

Secure the radiographic guide to the articulated models.

- Add bite index material between the radiographic guide and the opposing model and "bite" the jaws together to create a radiographic index.
- Radiographic indexes for edentulous and large span partially-edentulous patients should be fabricated in the articulator.
- Try-in the radiographic guide and radiographic index prior to the (CB)CT double scan.

Tip If the patient has only a few teeth in the opposing jaw and does not wear a partial prosthesis, be sure to fill up the edentulous area with enough occlusal index material to make contact with the alveolar ridge. This ensures a horizontal, well-balanced bite registration.



Fabrication of a new edentulous radiographic guide

1 Define diagnostic tooth setup

- Use denture teeth for tooth setup according to esthetic demands and functionality.
- Carefully consider the relationship between implant diameter and the width of chosen denture teeth (e.g., denture premolars are often too narrow to support implant prosthetics).



Tip Defining the intended final tooth setup is fundamental for prosthetic-driven implant planning.

2 Confirm occlusion and duplicate

- Confirm occlusion with articulated opposing model.
- Use your standard techniques to accurately replicate the diagnostic tooth setup in PMMA material, preferably the clear kind. PMMA must not contain any radio-opaque ingredients.



3 Trim radiographic guide

- Carefully remove excess acrylic and any sharp edges.
- Smooth and polish.



4 Place radiographic markers

To facilitate the (CB)CT double-scan protocol and enable the subsequent correct matching of the two scans in DTX Studio Implant software, six–eight spherical reference points must be added to the radiographic guide.

- Plan marker positions evenly spread on the lingual/palatal and buccal/labial regions using a felt marker.
- Ensure markers are placed above the gingival plane in the maxilla and below the gingival plane in the mandible.
- Distribute markers as asymmetrically as possible, ensuring that they will not end up in the same (CB)CT planes (this increases the accuracy of registration).
- Use a rose head bur to carefully make marker holes.
- Place spherical holes of 1 mm deep and 1–1.5 mm diameter.
- Fill holes with a radio-opaque material (preferred material is gutta percha).

Tip Check compatibility of material for markers with your (CB)CT scanner (manufacturer, model and firmware version as well as scan protocols) as some devices require materials that are less radio-opaque than gutta percha.

Contact the Nobel Biocare Technical Helpdesk for clarification.

Tips

- Avoid placing all markers in the same “axial” CT plane. Distribute in several planes.
- Ensure markers are randomly and well-distributed above the gingival plane.
- Avoid making the holes larger than indicated (larger volumes of gutta percha might cause artifacts and hamper the alignment process. As a rule of thumb, the spherical marker should be three times as big as the voxel size used for scanning).
- Avoid perforation of the radiographic guide with the markers.

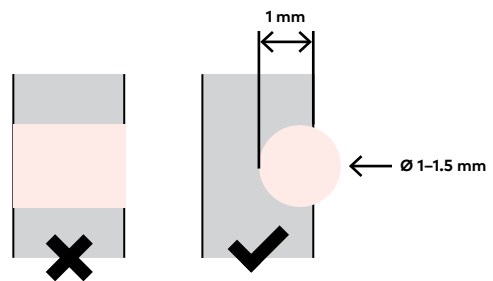

5 Make radiographic index

- Secure the radiographic guide onto the articulated models.
- Add bite index material between the radiographic guide and the opposing model and “bite” the jaws together to create a radiographic index.
- Radiographic indexes for edentulous and large span partially-edentulous patients should be fabricated in the articulator.
- Try-in the radiographic guide and radiographic index prior to the (CB)CT double scan.

Tip If the patient has only a few teeth in the opposing jaw and does not wear a partial prosthesis, be sure to fill up the edentulous area with enough occlusal index material to make contact with the alveolar ridge. This ensures a horizontal, well-balanced bite registration.



Digitization

CT scanning

The DTX Studio Implant software requires (CB)CT data as axial slices in DICOM format (Digital Imaging and Communication in Medicine). DICOM is an open and widely used standard for communicating medical images. The standard includes a file format which is used by the DTX Studio Implant software. CT and (CB) CT scanners have export functions for DICOM files. Use single or multi-frame, uncompressed DICOM files.

Modern CT scanning equipment

- Multi-slice CT scanner (medical CT scanner typically used in radiology departments of hospitals and radiology imaging centers).
- Cone-beam (CB)CT scanner (dedicated dental CT scanner using a cone shaped x-ray beam).

Quality specifications & scan settings

1 Check for scanner compatibility requirements

DTX Studio Implant software is compatible with CT scanners and (CB)CT scanners provided these basic requirements are met:

- The field of view is large enough to image an entire jaw bone. Typically, this means a minimal field of view with a diameter of 8 cm and a height of 7 cm.
- The resolution and related voxel size is a minimum of 0.5 mm in all directions, typically 0.3 mm.
- The diagnostic image quality is high enough for the clinician to appropriately read the CT image data.
- The CT scanner can export the axial CT slices as single or multi frame, uncompressed data.
- For (CB)CT scan protocols, see [page 137](#) in Appendices.
- When working with edentulous cases: The NobelGuide calibration procedure can be successfully completed.

Tips

- It is the responsibility of the clinician or the radiologist to generate CT images of optimal quality according to the standard routine and at as low radiation doses as possible. Use the 'ALARA principle' (As Low As Reasonably Achievable).
- For calibration procedure, see [page 136](#) in Appendices.

2 Scan protocol

a) For partially edentulous cases

- Scan the patient.
- Ensure the patient occlusal plane is positioned horizontally.
- Ensure quality of the scan with adequate resolution, optimized settings and reduced noise.



Tips

- Take into consideration patient factors such as metallic restorations which result in streak artifacts and patient movement.
- It is recommended that the occlusion is separated slightly using a wax plate or small wooden spatula in order to avoid obscuring important occlusal reference information by residual streak artifacts.

b) For edentulous patients

For edentulous cases a double-scan protocol is needed. This protocol allows the shape of the radiographic guide to be digitized with high accuracy, irrespective of the patient scan and its eventual related artifacts. Both scans will be aligned based on the markers in the radiographic guide. A single scan is not sufficient since the grey values of the acrylic radiographic guide are almost the same as for soft tissue.

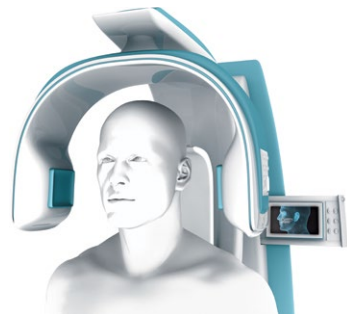

First scan: Patient

Scan the patient wearing the radiographic guide held in the correct position by occluding on the radiographic index.

Second scan: Radiographic guide

- Position the radiographic guide on a sponge or another foam-like material. Use paper tape to attach the radiographic guide if needed.
- Position radiographic guide in approximately the same orientation as it was positioned for the patient scan.
- Scan the radiographic guide.

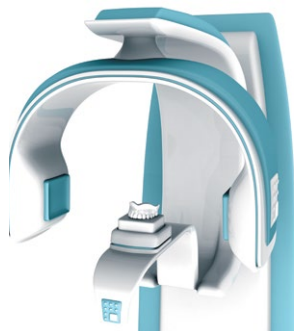

Tip Always ensure that the radiographic guide is scanned without the radiographic index.

3 Export (CB)CT data

Export scan data as uncompressed single or multi frame DICOM files.

4 Check quality

a) For partially edentulous cases - Scan complete dental arch

- Ensure that the entire dental arch is scanned including all teeth (prosthetic crowns).
- It is advised to separate the jaws slightly using a wax plate or wooden spatula, especially with heavily restored dentitions in order to clearly detect the occlusal relief.

Tip In order for the SmartFusion to work correctly in DTX Studio Implant the (CB)CT data and surface scan data must include the same information on prosthetic crowns. Modification of restorations in between the (CB)CT scan, surface scan and surgery might negatively impact SmartFusion and/or result in a non-fitting surgical template.



Incomplete scan of dental arch

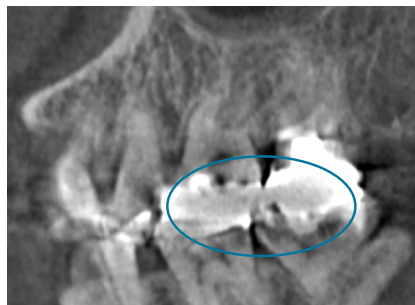

Occlusal information lost due to heavy artifacts and lack of separation of arches

b) For edentulous cases - Verify correct position of radiographic guide

Check whether there is 'air' between the radiographic guide and the patient gingiva. Air is visualized by dark (black) zones as illustrated. If these black zones show, it could indicate that the radiographic guide was incorrectly positioned during the (CB)CT scan. Please verify if this is the case. If so, the patient requires a new scan with the radiographic guide correctly positioned with the radiographic index.

Tip The field of view of the scanner has to be large enough to depict the radiographic guide (and also the calibration object) with one scan completely.

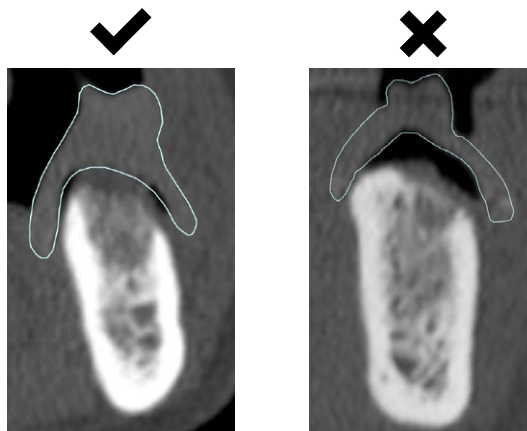

Check for patient movement during (CB)CT scan

Indicators for movement of the patient during scan include:

- CT: discontinuity of the anatomy.
- (CB)CT: double anatomical borders.
- If patient movement is identified, the scan must be repeated.

Tip Movement artefacts introduce inaccuracies in the CT image, potentially leading to incorrect diagnosis. They may also prevent the SmartFusion technology from working.

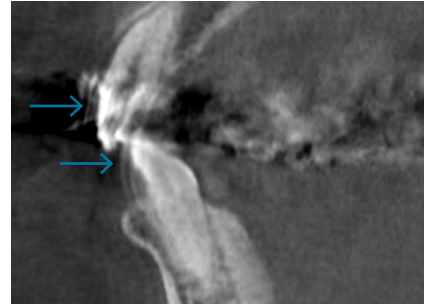

Movement of patient during (CB)CT scanning is evident by the 'double line' effect

Streak artefacts

- Streak artefacts from radio-opaque tooth restoration material corrupt diagnostic information.
- The SmartFusion technology is robust and has been developed to handle (CB)CT data with streak artefacts, however, when severe artefacts arise, this might cause issues.

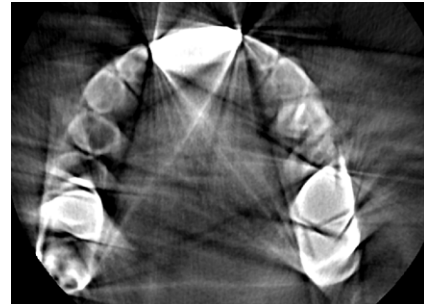

Excess streak artefacts due to heavily restored dentition.

Dental cast and diagnostic setup

The dental cast or surface scan from an intraoral scanner represent the clinical situation and it is on this data that the DTX Studio Implant software calculates the surgical template using the precision fit technology.

The dental cast or surface scan from an intraoral scanner must contain the same occlusal landmark information as captured in the (CB)CT scan. The diagnostic setup or the SmartSetup represent the desired final restorative outcome and enables visualization of this information during implant treatment planning.

If surface scan data is acquired taking an impression and ordering a dental cast and diagnostic setup, the dental cast and diagnostic setup must be scanned using a desktop scanner.

1 Dental cast

Pour dental cast with care, using type 4 CAD stone. The dental cast should represent the same clinical situation as captured in the (CB)CT scan.

The impression quality must meet requirements of a definitive impression for the intended treatment. An incorrect dental cast could lead to a poorly fitting surgical template.

Tip Minimally trim model to ensure all information will be captured in dental cast scan.



2 Diagnostic setup

Create removable diagnostic (prosthetic setup / wax-up) using

- CAD wax
- Acrylic
- CAD acrylic
- Any other material using CAD spray before scanning



3 Diagnostic setup scan

Add the diagnostic setup to dental cast.

Tip Do not move the dental cast in the scanner holder. The same position must be maintained for the prosthetic setup scan.



4 Dental cast scan

Secure dental model in the desktop scanner and scan dental model according to the scan protocol.

Tip Ensure that the dental cast scan captures the entire arch of the model.



Tooth extraction using a dental cast (partially edentulous cases)

Single tooth treatment efficiency model

The NobelGuide treatment workflow for partially edentulous patients supports extraction and immediate implant placement of a single tooth. The selected tooth is removed from the dental cast and a removable prosthetic (diagnostic) setup can be added before the model is scanned. This modified dental scan information, is aligned with the (CB)CT data in the DTX Studio Implant software in order to finalize the treatment plan and if desired, order a surgical template to support either pilot drilling or fully guided surgery.

1 Select tooth

Mark tooth to be removed from the dental cast.



2 Remove tooth

Carefully grind the selected tooth away using a laboratory bur.

Tip Take care not to damage any of the surrounding tooth structure.



3 Diagnostic setup

- Continue with removable diagnostic setup if applicable.
- Scan dental cast and setup in a desktop scanner.





Important considerations before surgery

Surgical template 40

Fabrication of stone model and surgical index 46

Checklist before surgery 53

Surgical template

Surgical template in DTX Studio Implant software

The surgical template helps you to perform surgery exactly as planned.

1 Create surgical template in DTX Studio Implant software

The virtual surgical template created when finalizing the planning is a preview of what will be produced after ordering or what the .stl file will look like for local production.

2 Inspect surgical template

Carefully review surgical template preview ensuring that all planned sleeves are sufficiently supported by the template material. For further information, please refer to the DTX Studio Implant Instructions For Use.

3 Review all triggered warnings

Review the DTX Studio Implant assistant warning section and adjust accordingly. For further information, please refer to the DTX Studio Implant Instructions For Use.

Centralized production of surgical template and shipment

The NobelGuide surgical template is produced by Nobel Biocare. It is shipped non-sterile in a protective bag which contains a moisture absorbent sachet. The surgical template is made from a material that is sensitive to moisture and excessive sunlight.

Tips

- Store the surgical template together with the moisture absorbent sachet in the protective plastic bag in which it was delivered.
- Do not remove the moisture absorbent sachet.
- Store the surgical template in a dry, dark location.
- Do not expose the surgical template to direct sunlight.
- Surgery should be performed prior to the expiry date noted on the template label.

Storing dimension stability tests show:

- You should store in a dry environment using the well-sealed protective plastic bag with moisture absorbent sachet.



1 Examine surgical template

- Confirm that the treatment ID on the surgical template corresponds with the treatment ID (as detailed in the order manager in the DTX Studio Implant software) and virtual treatment plan in the DTX Studio Implant software.
- Confirm that the minimum thickness is 2.5 mm across the entire surface of the template to ensure the structural integrity of the template is maintained.
- Strengthen/reinforce the template where needed by reinforcing the outer surface with a compatible photocuring resin material.



2 Inspect surgical template

- Inspect the guide sleeves to ensure they are free of excess material.
- Confirm the fit of the guided drill guides and if applicable, the guided drills into the guided sleeves.
- Confirm that the surgical template fits to the same dental cast scanned in a desktop scanner (if produced) and to the clinical situation.



3 Clean the surgical template

- Surgical templates must be cleaned and disinfected prior to intraoral use. During processing in the dental laboratory, templates can be cleaned as necessary without disinfection.
- Refer to the Cleaning and Disinfection part in the Instructions For Use for the NobelGuide Surgical Templates and Guided Anchor Pins.

Local production of surgical template

If a template should be manufactured locally, a customer can select this in the DTX Studio Implant software. The file to manufacture a template (.stl file) is downloadable from the DTX Studio Go website.

For details on how to order and download an .stl file, please refer to the DTX Studio Implant software Instructions For Use.

1 Inspect locally produced surgical template

- Check the sleeve seats for material residues and sharp, protruding edges. Remove or smoothen them if you find any.
- Check that the locally produced surgical template is manufactured from appropriate material: the material should be biocompatible and mechanically fit for purpose. Recommended material properties are listed in the Instructions For Use for the Guided Pilot Drill Sleeves, Guided Sleeves, and Guided Anchor Pin Sleeves.
- Verify optimal fit on stone model if applicable and/or in patient's mouth prior to surgery.

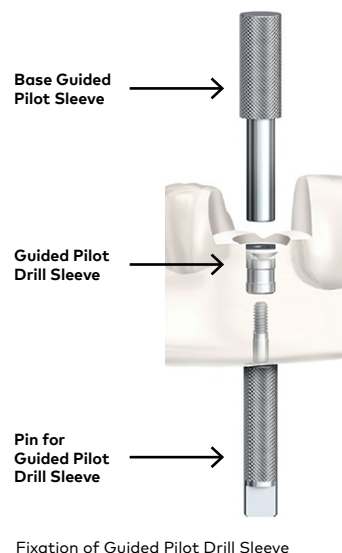

Fixation of Guided Pilot Drill Sleeve

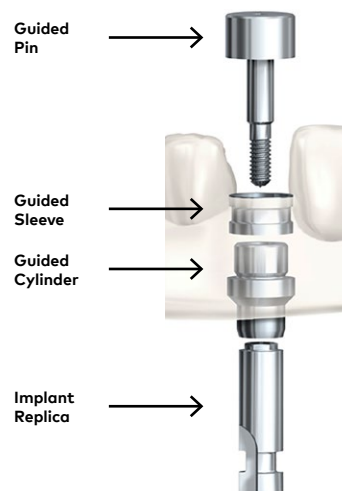

Fixation of Guided Sleeve

2 Fixing the sleeves into the locally produced surgical template

- Insert the sleeves into the sleeve seat of the surgical template.
- Visually verify that the sleeves are flush with the top surrounding surface of the surgical template. If they are not flush, remove material as required.
- In local production of surgical templates, the mounting tools are used to glue the sleeves into the surgical template (exception: anchor pin sleeves; no mounting tool is needed).
- For permanent fixation of the sleeves a biocompatible glue/cement/adhesive agent is needed. The user must use a biocompatible material and follow the manufacturer's Instructions For Use. Recommended material properties are listed in the Instructions For Use for the Guided Pilot Drill Sleeves, Guided Sleeves, and Guided Anchor Pin Sleeves.

3 Cleaning the locally produced surgical template

- Following fixation and bonding of the sleeves into the surgical template, the surgical template construct must be cleaned and disinfected prior to intraoral use.
- Refer to the Cleaning and Disinfection part in the Instructions For Use for the Guided Pilot Drill Sleeves, Guided Sleeves, and Guided Anchor Pin Sleeves.

Notes

- Make sure that the flat upper part of the Guided Pilot Drill Sleeve is on the occlusal surface of the surgical template.
- The outer diameter of the Guided Pilot Drill Sleeves (1.5 mm and 2.0 mm) is the same.
- The Guided Sleeves are symmetrical and have no top or bottom.
- The Guided Anchor Pin Sleeve is symmetrical and has no top or bottom.
- Once all the Guided Pilot Drill Sleeves, Guided Sleeves and Guided Anchor Pin Sleeves are in place, glue them into the surgical template.

Caution Introduce only as much bonding material as needed to cover the outer diameter of the Guided Pilot Drill Sleeves, Guided Sleeves, and Guided Anchor Pin Sleeves in the glue channel. Observe the glue channel while introducing the bonding material in order to avoid introducing excessive material. Immediately remove any excess bonding material using a suitable instrument.

Caution Guided Pilot Drill Sleeves, Guided Sleeves and Guided Anchor Pin Sleeves are single use products and must not be reprocessed. Reprocessing could cause loss of mechanical, chemical and/or biological characteristics. Reuse could cause local or systemic infection.

Fabrication of stone model and surgical index

Surgical template

The surgical template is the guide for placing implants as virtually planned. Using dedicated laboratory tooling, it can also hold implant replicas at intended positions allowing for the fabrication of a stone model containing these replicas prior to surgery. This allows for preparation of provisional prosthetic solutions which are to be finalized directly after surgery.

Surgical index

The surgical index is used during surgery to correctly position the surgical template on the jaw before anchoring with Guided Anchor Pins.



Guided Cylinder with Pin

A key component to produce a stone model is the Guided Cylinder with Pin. The guided cylinder (1) and pin (2) ensure the geometrical relation between the guided sleeve (3), which is included with the surgical template, and the implant replica (4).

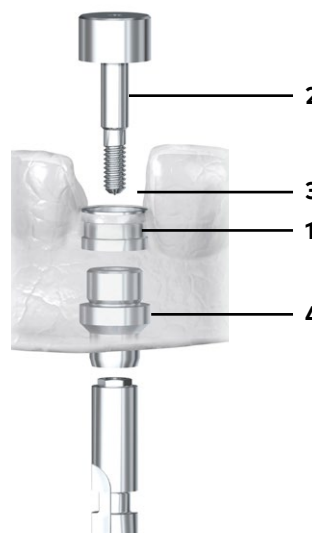

Edentulous

1 Mount implant replicas

- Connect the Guided Cylinder with Pin to the implant replicas through the sleeves in the surgical template.
- Replica and cylinder type are based on the implant system used in the digital treatment plan.



2 Position Guided Anchor Pins

Insert anchor pins into anchor pin sleeves.



3 Add soft tissue mask

- Lubricate the bottom of the Guided Cylinder with Pin and the fitting surface of the surgical template with Vaseline for easy dismounting of the soft tissue replica.
- Add the soft tissue mask using a small nozzle.
- Use soft tissue replica or boxing wax on buccal side of the vestibular extension to prevent die stone from locking to surgical template.



Tip Ensure material reaches right down to the Guided Cylinder with Pin to achieve an accurate replica of the soft tissue.

4 Apply isolation

Protect surgical template against gypsum by using either gingiva mask or isolation material.



5 Pour model

Use die stone to pour the stone model.



6 Remove surgical template

Once the die stone has set:

- Remove anchor pins.
- Remove Guided Cylinder with Pin using a Unigrip Screwdriver.
- Remove the surgical template.



7 Remove excess material

- Use a scalpel to trim any excess soft tissue mask material.
- Trim excess die stone material.



8 Mount model in articulator

- Attach the radiographic guide as used for (CB)CT scan (or the duplicate denture ordered via the DTX Studio Implant software) onto the stone model.
- Mount the stone model in an articulator together with the model of the opposing jaw.
- Use the radiographic index to verify the correct occlusion.
- Replace the optimized prosthesis or duplicate denture with the surgical template and secure with anchor pins.

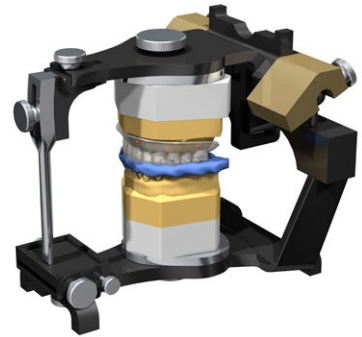

9 Make surgical index

- Use lab putty to make the surgical index.
- Add index material between the surgical template and the opposing model and 'bite' the jaws together.
- Use enough material to create a solid and strong index.

Tip If the patient only has front teeth in the opposing jaw and does not wear a partial prosthesis, build up the surgical index in the area where the teeth are missing to ensure contact with the alveolar ridge. This is to ensure that there is a horizontal, well-balanced bite index.

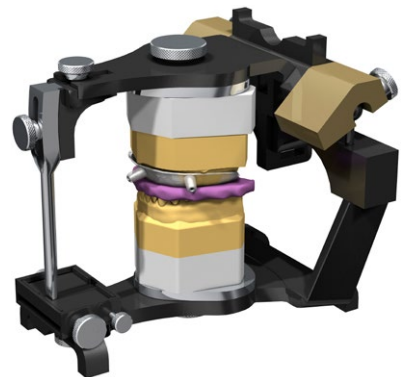

10 Store surgical template

- Disinfect surgical template and index before returning to clinician.
- Ensure surgical template is returned to the UV-protective bag in which it was delivered along with the surgical index.

Tip The surgical template should be thoroughly dried prior to being stored in the UV-protective bag.

Partially edentulous

1 Verify fit of surgical template

- Use the original stone model to verify the correct seating of the surgical template.
- Confirm via inspection windows, if applicable.

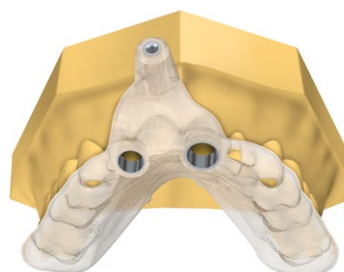

2 Section model

- Mark approximate implant locations on the model.
- Cut away section in order to make room for the implant replicas.



3 Mount implant replicas

- Connect the Guided Cylinder with Pin to the implant replicas through the sleeves in the surgical template.
- Replica and cylinder type are based on the implant system used in the digital treatment plan.



Tip When using an engaging abutment (i.e. a rotational lock abutment), position the implant replicas as follows:

- For implants with an external hex connection, rotate so that the side of the hex is parallel with the curvature of the jaw.
- For implants with an internal tri-channel connection, rotate so that a lobe of the internal connection is oriented buccally/labially.
- For implants with an internal conical connection, rotate so that internal hex is parallel to the buccal/facial wall.

4 Position guided anchor pins

Insert anchor pins into anchor pin sleeves, if applicable.

Tip Verify that the implant replicas are secured properly and that they also passively fit in the cut-away section of the stone model.



5 Add soft tissue mask

- Lubricate the bottom of the Guided Cylinder with Pin and the fitting surface of the surgical template with Vaseline for easy dismantling of the soft tissue mask.
- Add the soft tissue mask.
- Use soft tissue mask or boxing wax on buccal side of the vestibular extensions to prevent die stone from locking to surgical template.



6 Reconstitute stone model

- Position the surgical template on the stone model.
- Use sticky wax to secure the correct position of the surgical template, as verified via the inspection windows.
- Fill the area to be restored with die stone.
- Verify correct seating of the surgical template via the inspection window throughout the stone-setting process.

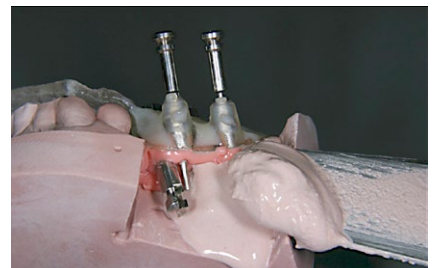

7 Remove surgical template

Once the die stone is set:

- Remove the anchor pins.
- Remove Guided Cylinder with Pin using a Unigrip Screwdriver.
- Remove the surgical template.

8 Remove excess material

- Use a scalpel to trim any excess soft tissue mask material.
- Trim excess die stone material.

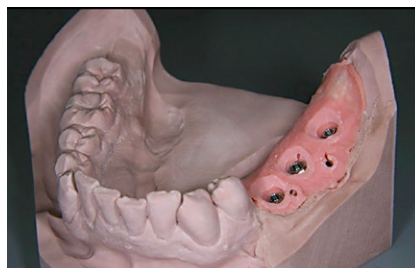

9 Mount model in articulator

- Mount in an articulator together with a stone model of the opposing jaw using a bite index.
- If required, use lab putty to make a surgical index.
- Add index material between the surgical template and the opposing model and 'bite' the jaws together. Use enough material to create solid and strong index.



Tip If the patient only has front teeth in the opposing jaw and does not wear a partial prosthesis, build up the surgical index in the area where the teeth are missing to ensure contact with the alveolar ridge. This is to ensure that there is a horizontal, well-balanced bite index.

10 Store surgical template

- Disinfect the surgical template before returning to the clinician.
- Allow the template to air-dry thoroughly, but for no longer than 40 minutes.
- Ensure the surgical template is returned to the protective bag in which it was delivered or in another suitable protective container.

Checklist

BEFORE surgery

- Use correct surgical template – either manufactured by Nobel Biocare (including the NobelGuide surgical guidelines document) or the locally produced surgical template
- When using a NobelGuide (manufactured by Nobel Biocare) confirm that treatment ID on surgical template corresponds with treatment ID in the DTX Studio Implant software (order manager)
- Print treatment plan report from the DTX Studio Implant software
- Verify the virtual treatment plan corresponds with the surgical template design
- Verify exact fit of the surgical template on master cast and/or clinically in the patient before treatment
- Confirm that surgical index, if applicable, fits the surgical template and patient's opposing jaw when occluding
- Confirm that all required implants, surgical components and instruments have been ordered and received
- Confirm prosthetic components, if applicable
- Strictly follow the treatment protocol from the correct patient treatment plan report from the DTX Studio Implant software (implants, length/diameter, drill depths), following Nobel Biocare Instructions For Use (ifu.nobelbiocare.com)

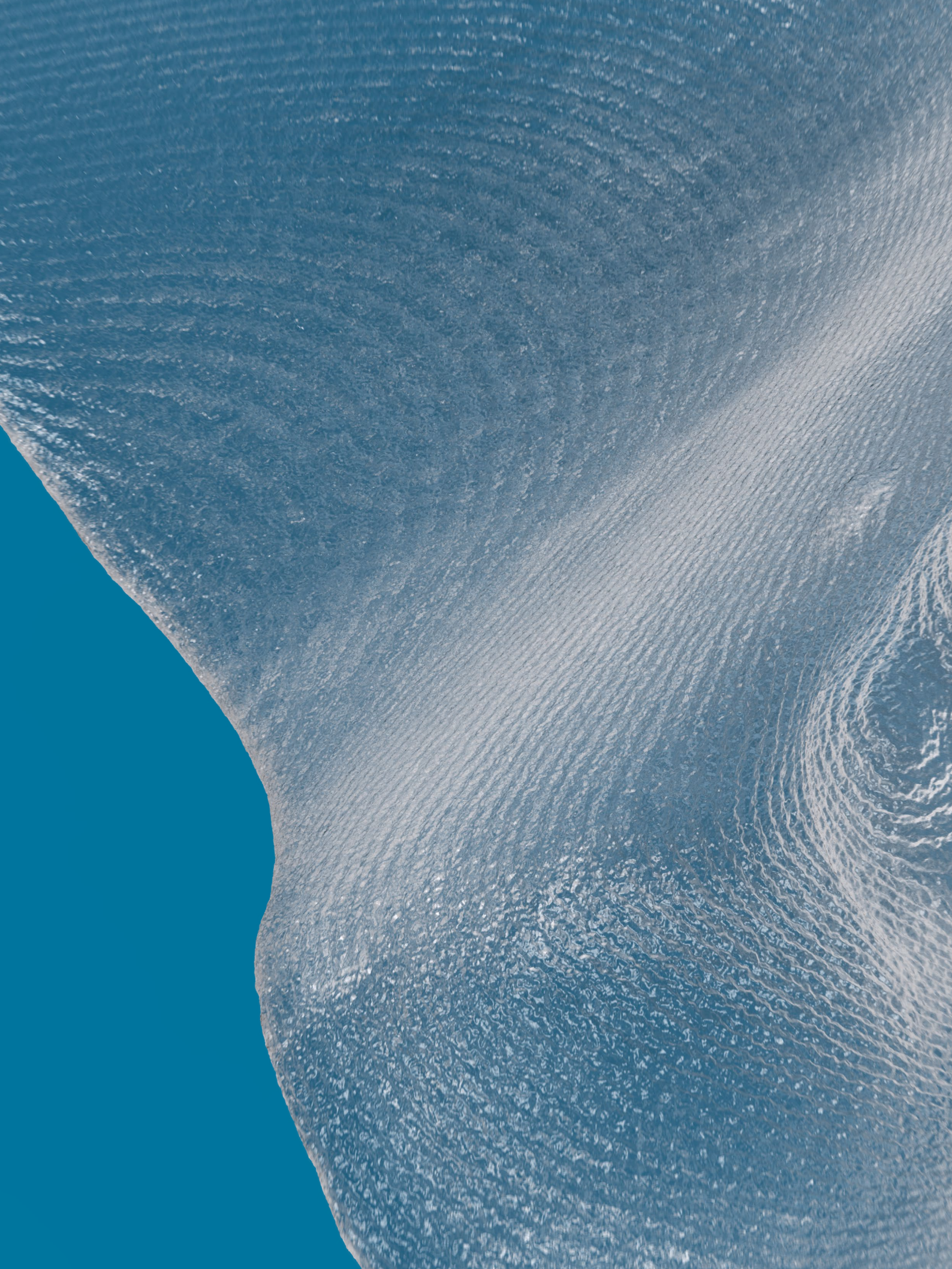

Surgical procedure

Anchoring the surgical template	56
Guided pilot drilling procedures	58
Implant insertion	63
Special drilling considerations for NobelActive® TiUltra™ 3.0	68
Fully guided drilling procedures	70
Common drilling considerations	73
Wallchart NobelActive® Guided PureSet™	78
Wallchart NobelParallel™ CC Guided PureSet™	80
Wallchart NobelReplace® CC Guided PureSet™	82
Guided drilling and implant placement NobelActive® TiUltra™	87
Guided drilling and implant placement NobelParallel™ CC TiUltra™	99
Guided drilling and implant placement NobelReplace® CC TiUltra™	110

Anchoring the surgical template

Position according to radiographic guide for edentulous cases

The radiographic guide is held in place by a radiographic (bite) index during the CT scan. Before surgery, the surgical template must be placed with maximum attention to find the exact same position the radiographic guide had during the CT scan. The use of a laboratory-produced surgical index to help position the surgical template before surgery is mandatory.

Guided Anchor Pins

An adequate number of anchor pins strategically positioned and orientated during planning can be placed, providing additional security that the surgical template is in the correct position during surgery and maintains this position for the duration of the procedure. The osteotomy for the placement of the Guided Anchor Pins is prepared using the Guided Twist Drill Ø 1.5 x 20 mm.

During surgery maximum attention must be paid to ensure that the surgical template does not move in any direction from the correct position when being manipulated with instruments, e.g. lateral shift through inadequate handling of (pilot-)drills in 'knife-edge ridge' situations or shift/deformation of surgical template due to excessive vertical force application during implant installation.

In situations where two or more neighboring implants are placed, regardless if it is a free-end situation with one or more distal teeth for support of the surgical template, it is recommended to use at least one anchor pin in this area.

1 Administer local anesthesia

Prior to the surgical procedure, administer local anesthesia and allow it to fully dissipate within the mucosal tissue (10–15 minutes). This ensures that the surgical template will have maximum contact without displacement and be seated in the proper position.

2 Position surgical template

- For edentulous cases, verify surgical template is positioned correctly on the ridge.
- For partially edentulous cases, verify correct seating by ensuring there is no gap between the existing dentition at all locations simultaneously.
- Position the surgical template using the surgical index, if applicable, to ensure correct positioning while anchor pins are placed.

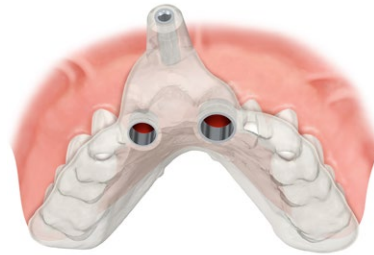

3 Drill

When the surgical template is in the correct position, drill through the anchor pin sleeve and soft tissue into the osseous tissue using Guided Twist Drill Ø 1.5 mm × 20 mm to the stop on the drill. Ensure irrigation is switched on and use an in-and-out motion while drilling in bone for 1–2 seconds.

Maximum speed 800 rpm

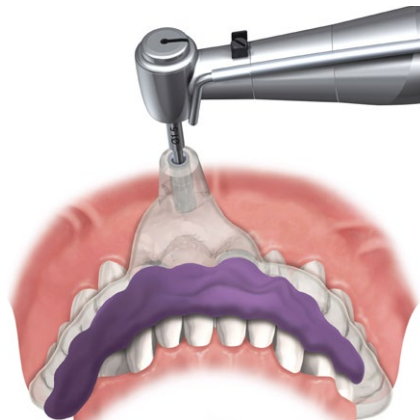

4 Place anchor pin

- Place a Guided Anchor Pin Ø 1.5 mm fully into the sleeve to secure the surgical template is in position.
- Proceed with the same protocol for the remaining anchor pins to achieve good initial stability.
- Anchor pins are available in regular version (no specific name) or short shaft version. The short shaft version is designed to be placed in more posterior locations where lip retraction is not regarded as benefit, as it would limit overall mouth opening.



Guided pilot drilling procedures

Important

- Use the DTX Studio Implant treatment plan report and/or the NobelGuide surgical guidelines packaged with the surgical template to prepare and perform the treatment with reference to implant system, diameter and length of implant and the guided drill depth at each site.
- The Guided Pilot Twist Drill Ø 1.5 mm and Guided Twist Drill Ø 2.0 mm are identified by the (10+) designation of the shaft, which indicates the drills extend 10 mm. All measurements are taken from the tip of the drill to the bottom of the depth marking.

Surgical access

Option 1

Perform flap elevation prior to guided drilling through the surgical template.

- Carefully position the surgical template.
- Using the first drill in the indicated drilling protocol, carefully mark the soft tissue.
- Remove the surgical template.
- Perform the incision.
- Elevate the flap by performing subperiosteal preparation and mobilization using a raspatory or elevator.
- Carefully reposition the surgical template.*
- Perform guided drilling using the selected guided pilot drills based on the treatment plan report.
- Remove the surgical template.
- Continue site preparation and/or implant insertion.

Option 2

Perform guided drilling through the surgical template before performing flap elevation.

- Carefully position the surgical template.
- Perform guided drilling using the selected guided pilot drills based on the treatment plan report.
- Remove the surgical template.
- Perform the incision.
- Elevate the flap by performing subperiosteal preparation and mobilization using a raspatory or elevator.
- Continue site preparation and/or implant insertion.

*Ensure the exact same fit and position is achieved as before soft tissue manipulation.

Pilot drilling procedures

(all implants, including NobelActive TiUltra 3.0)*

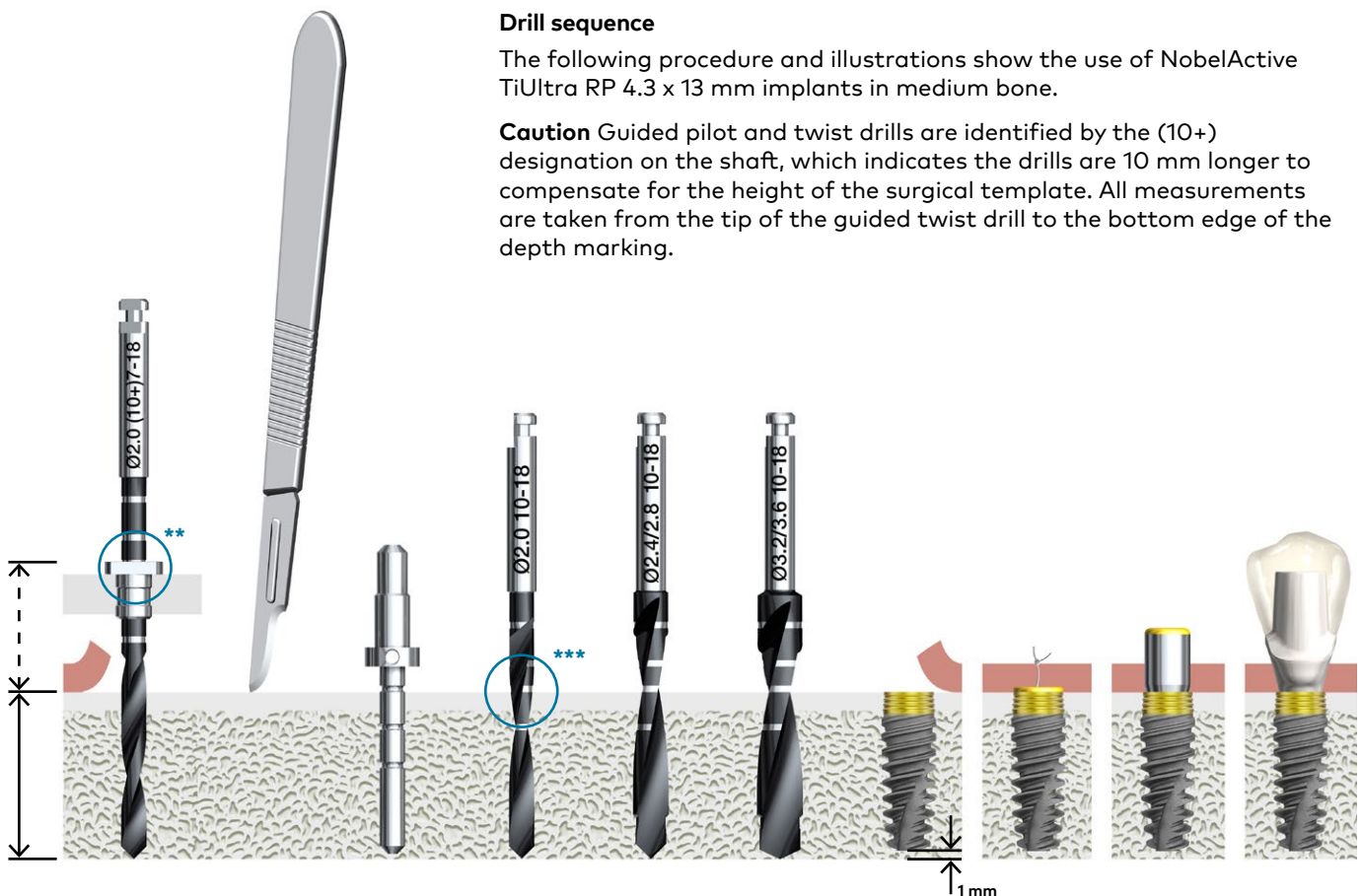

Drill sequence

The following procedure and illustrations show the use of NobelActive TiUltra RP 4.3 x 13 mm implants in medium bone.

Caution Guided pilot and twist drills are identified by the (10+) designation on the shaft, which indicates the drills are 10 mm longer to compensate for the height of the surgical template. All measurements are taken from the tip of the guided twist drill to the bottom edge of the depth marking.

* Surgical template with Ø 2 mm pilot drill sleeves. For NobelActive TiUltra 3.0 a Ø 1.5 mm pilot drill sleeve is available when soft bone is confirmed.

** Drill depth as printed on treatment plan report/surgical guidelines.

*** Identify drill depth and define new landmark reference for freehand drills.

1 Position surgical template

- Carefully and correctly position the surgical template. Secure using anchor pins, if applicable (for details see [page 56](#)).
- Keep the surgical template stabilized at all times during the surgery.



2 Drill with Pilot Twist Drill

Drill with the Guided Twist Drill \varnothing 2.0 x (10+)7–18 mm (optionally use the Guided Twist Drill \varnothing 2.0 x (10+)7–13 mm) to the desired depth with an in-and-out motion under profuse irrigation.

Maximum speed 800 rpm



Caution Guided pilot and twist drills are identified by the (10+) designation on the shaft, which indicates the drills are 10 mm longer to compensate for the height of the surgical template. All measurements are taken from the tip of the guided twist drill to the bottom edge of the depth marking.

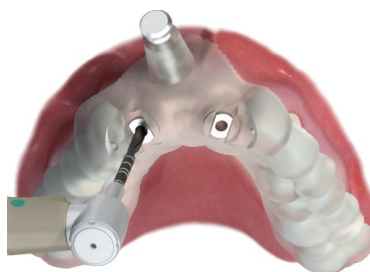

Tip Correct guided drill depth information must be confirmed by referencing the printed treatment plan report from DTX Studio Implant and/or the NobelGuide surgical guidelines included in the surgical template package.

3 Remove surgical template

Carefully remove the surgical template.

4 Confirm orientation

Use the direction indicator to confirm orientation and inclination of the preparation.



5 Identify osteotomy depth

- Identify reference for osteotomy depth for freehand surgery.
- Use a depth probe with depth markings and/or the Twist Drill \varnothing 2.0 (not rotary) to identify the depth for freehand surgery with reference to the patient's anatomy.
- Complete drill protocol according to bone density.

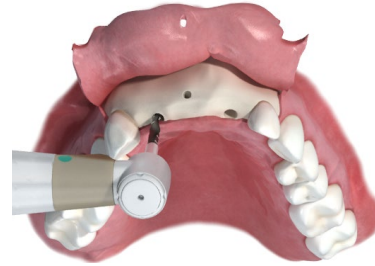

Tip The following illustrations show the use of NobelActive TiUltra RP 4.3 × 13 mm implants. Please refer to appropriate freehand drilling procedures for the selected implant system.

6 Check osteotomy direction

Check correct direction using Direction Indicator \varnothing 2.0/2.4–2.8 mm.

Tips

- If applicable, take a radiograph to verify correct direction.
- When placing multiple implants, proceed to the next implant site before continuing to next drill sequence.

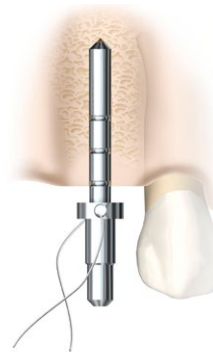

7 Drill with Twist Step Drills

- Continue site preparation using Twist Step Drill \varnothing 2.4/2.8 mm.
- Check orientation using Direction Indicator \varnothing 2.0/2.4–2.8 mm.
- Finalize site preparation using Twist Step Drill \varnothing 3.2/3.6 mm.

Maximum speed 2000 rpm

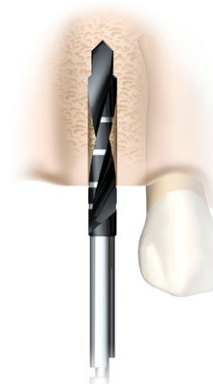

8 For dense bone only: widen cortex

Widen cortex to full cortex depth using Twist Step Drill Ø 3.8/4.2 mm. Do not drill to full drilling depth.

Maximum speed 2000 rpm



9 Use of screw tap in dense bone

- Place Screw Tap RP 4.3 into prepared implant site using low speed (25 rpm).
- Apply firm pressure and begin rotating the screw tap slowly.
- When the threads engage, allow screw tap to feed without pressure to defined depth.
- Switch the handpiece to reverse mode and back the screw tap out.

Low speed 25 rpm



Implant insertion

1 Unpack implant

Each implant comes in a double sterile vial: the implant held in an inner titanium vial (a) that is packed in plastic vial with screw lid, which acts as first sterile barrier (b). The plastic vial with screw top lid is packed in a blister sealed with a lid, which is the second sterile barrier (c). The blister is packed together with an implant card (d) and patient record labels (e) in a cardboard box (f).

The cardboard box and the blister have a printed label with product data including diameter and length.

The vial is laser marked with implant data including name, diameter and length (a). The inner titanium vial cap is color coded to identify the implant diameter.

- Open the box and ensure the implant card and patient record labels are removed.
- Peel off the sealed blister lid in order to open it and allow the plastic vial on the sterile field.
- Unscrew the lid and take out the sterile titanium vial, then lift off the color-coded cap to gain access to the implant.
- Record the implant size and LOT number on the patient's profile records with the provided peel-off labels available in the box. After surgery, provide the implant card, completed with the implant information, to the patient to keep for future reference.

All NobelActive TiUltra implants are delivered without a cover screw.



a) Inner vial

b) Plastic vial

c) Blister



d) Implant card



e) Patient record labels

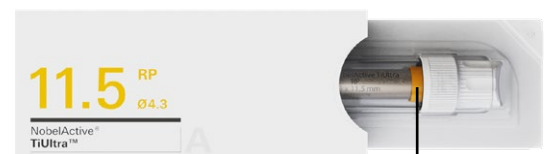

f) Cardboard box

The color of the implant vial cap refers to the diameter of the implant.

2 Choose insertion instrument

Depending on the clinical situation and accessibility, there are three different options for implant placement:

Manual placement:

- a) with a NobelActive Manual Torque Wrench Surgical
- b) with a Surgical Driver

Machined placement:

- c) with a drilling unit with contra-angle

Tip

- In the anterior region it is recommended to use the Surgical Driver to facilitate good control during insertion and angulation changes.
- The Surgical Driver is intended to be used while grasped with fingertips only to avoid excessive insertion torque.
- For NobelActive TiUltra 3.0, the NobelReplace Manual Torque Wrench Surgical or the Manual Torque Wrench Prosthetic with Surgical Wrench Adapter can also be used, as they both have a 45 Ncm marking.



a) NobelActive Manual Torque Wrench Surgical



b) Surgical Driver



c) Drilling unit with contra-angle

3 Pick up implant

- Connect the appropriate implant driver to the insertion instrument.
- Pick up the implant from the inner casing by applying light pressure on the implant driver and carefully turning the casing counterclockwise until implant driver is fully seated.

Tip The implant drivers have markings to facilitate the insertion of the driver into the implant.

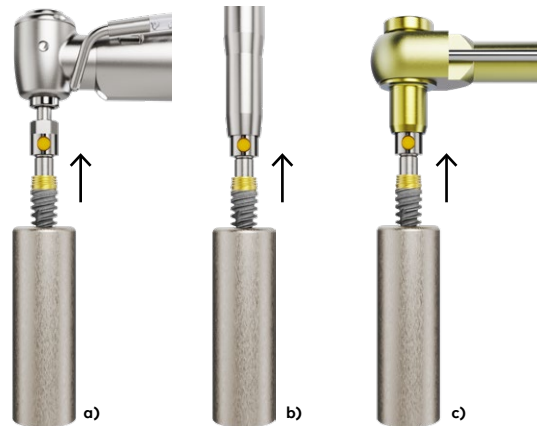

Tip Make sure that the implant driver is fully seated.

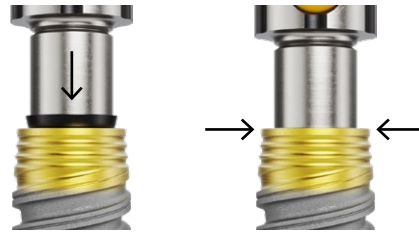

4 Machined implant placement

- When using a drilling unit, start inserting the implant using low speed: max 25 rpm.
- Remove implant driver with a gentle upward motion.

Low speed 25 rpm
Max. torque 70 Ncm



5 Manual implant placement

- Connect the Manual Torque Wrench Adapter together with the implant driver to the NobelActive Manual Torque Wrench Surgical and place the implant to final depth.
- Remove implant driver with an upward motion.

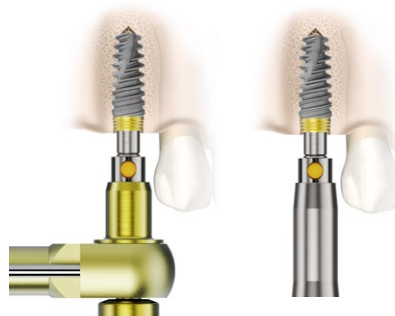

Caution Never exceed insertion torque of 45 Ncm for a NobelActive TiUltra 3.0 implant and 70 Ncm for NobelActive TiUltra 3.5, 4.3, 5.0 and 5.5 implants. Overtightening an implant may lead to damage of the implant, fracture or necrosis of the bone site. If a Surgical Driver is used to insert the implant, special care needs to be taken to avoid overtightening.

For Immediate Function, the implant should withstand a final insertion torque of at least 35 Ncm.

Procedure for implant placement in dense bone

For more detailed information regarding implant placement in dense bone and NobelActive screw taps, refer to [page 89](#).

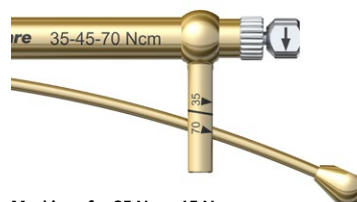

Markings for 35 Ncm, 45 Ncm and 70 Ncm.

6 Final implant placement

- Available abutment margin height needs to be considered during the planning of implant placement to assure appropriate seating depth of the implant relative to the available soft tissue thickness and the planned emergence of the restoration.
- For maximum esthetic results place the implant on the level of the buccal bone or 0.5 –1 mm below.
- When placing the implant, align one of the black hex indicators on the implant driver parallel to the buccal wall. This ensures that one of the flat sides of the hexagon is parallel to the buccal side, ensuring preferred prosthetic abutment orientation.

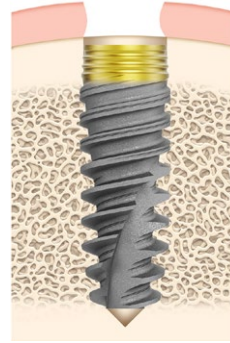

Tips

- The implant driver has a 3 mm height indicator to facilitate vertical implant positioning.
- If the implant driver is difficult to remove, slightly rotate it counterclockwise before lifting it up.

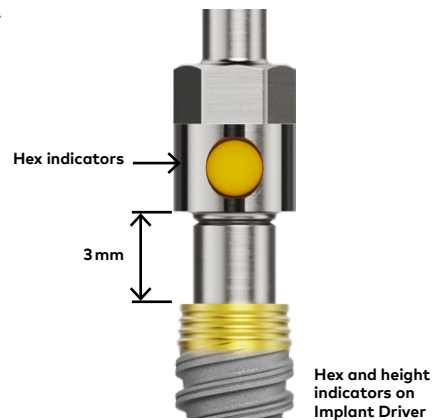

Special drilling considerations for NobelActive® TiUltra™ 3.0

Indications (specific to NobelActive TiUltra 3.0)

- NobelActive TiUltra 3.0 implants are intended to replace a lateral incisor in the maxilla and/or a central or lateral incisor in the mandible.
- NobelActive TiUltra 3.0 implants are indicated for single-unit restorations only.

Contraindications (specific to NobelActive TiUltra 3.0)

- NobelActive TiUltra 3.0 implants are not indicated to be used to replace a central incisor, a canine, a premolar or a molar in the maxilla nor to replace a canine, a premolar or a molar in the mandible.
- NobelActive TiUltra 3.0 implants are not indicated to be used for multiple tooth replacements.

1 Prepare implant site

Prepare the implant site according to the guided pilot drilling procedure (see [page 58](#)).

2 Pick up implant

Open the implant package and pick up the implant from the inner casing with the implant driver for NobelActive TiUltra 3.0.

3 Final implant placement

- Insert the implant with low speed, maximum 15 rpm, using drilling machine or by hand using Manual Torque Wrench Surgical.
- Due to the narrow implant diameter and narrow implant abutment connection, the maximum insertion torque for NobelActive TiUltra 3.0 differs from the entire NobelActive TiUltra assortment.
- Place the implant with an insertion torque of maximum 45 Ncm (see marking on torque wrench). For Immediate Function, a minimum installation torque of 35 Ncm is required.

Tip For NobelActive TiUltra 3.0, the NobelReplace Manual Torque Wrench Surgical or the Manual Torque Wrench Prosthetic with Surgical Wrench Adapter can also be used, as they both have a 45 Ncm marking.



4 Temporary restoration

Depending on the surgical protocol of choice, place a cover screw or abutment and suture.

Caution Never exceed prosthetic tightening torque of 15 Ncm for the abutment screw. Overtightening of the abutment screw may lead to screw fracture.

Tip Use the Screwdriver Machine UniGrip and Manual Torque Wrench.

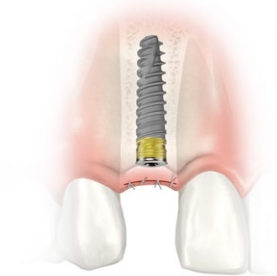

Fully guided drilling procedures

Surgical access – soft tissue management

The NobelGuide concept supports flap, mini-flap and flapless procedures. Flapless procedures are aided by a guided soft tissue punch.

Based on the actual case, the clinician is advised to choose the preferred option at the planning stage. Thorough clinical diagnostics and inspection are needed prior to planning – for instance to diagnose availability of keratinized mucosa around the prospective implant sites.

Tips

- The combination of tissue grafting and Immediate Function is not recommended.
- If simultaneous bone augmentation is performed, submerged healing is indicated until sufficient osseointegration has taken place.

Flapless procedure

The flapless procedure is the most straightforward procedure. The surgical template can remain at its initially installed position without the need to detach and re-position it again. This procedure is indicated for surgeons starting with the system, however punching of soft tissue must be clinically indicated (i.e. esthetics).



Soft tissue punch

If soft tissue punching is applied, its effect is maximized when used at the beginning of the procedure (non-penetrated mucosa). This generates clean surgical cuts with controlled cut margins following the dimensions of the punch.

Tip Using a punch at the end of the implant installation procedure may not allow for removal of small soft tissue remnants and may complicate prosthetic abutment connection.



Mini-flaps and flaps

- Prior to any manipulation of the soft tissue, securely position surgical template using surgical index to confirm position.
- Check for the correct initial positioning of the surgical template.
- Drill and place anchor pins. Use an in-and-out drilling motion with copious irrigation (for details see [page 56](#)).



Maximum speed 800 rpm

1 Mark implant positions

- Mark intended implant positions through the installed template by gently stamping the contour of the entry point of the implant.
- Use gentle force onto the soft tissue using the soft tissue punch.

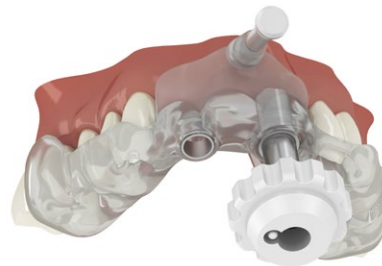

2 Perform incision with scalpel

- Remove the anchor pins and the surgical template.
- Perform the incision, respecting the position of the implants (the shown flap design is for illustration only).



3 Elevate flap

Perform sub-periosteal preparation and mobilization using a raspatory.



4 Modify surgical template

- Slightly modify the base of the surgical template by relieving as much material as needed.
- After grinding, rinse with sterile physiologic liquid (saline) to remove any small particles.

Tip Ensure adequate thickness of the surgical template is maintained at these sites.



5 Reposition surgical template

Reposition the surgical template using the surgical index and the exact same site prepared for the anchor pins.

Tip Anchor pins may also be planned in order to assist retracting a flap. Also, the flanges of the surgical template itself may be used to retain a flap.

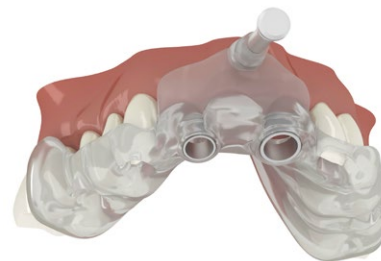

Common drilling considerations

Handle for Guided Drill Guide

The drill guides are attached to the Handle for Guided Drill Guides by inserting the ball of the drill guide into the tip of the handle. The drill guide is locked into place by firmly tightening the upper part of the handle. Note that the drill guide is free to rotate in the socket of the handle before it is locked into place. This is to ensure that the drill guide and handle can be positioned in such a way so that it does not interfere with other surgical instruments.

For easier and faster handling of the Guided Drill Guides, these tools have one to three lines depending on the platform they are used for, as well as the number of the drill they are used with. The Guided Drill Guides show one line for the narrow platform (NP), two lines for the regular platform (RP), and three lines for the RP (5.0) and wide platform (WP). Each drill has a number, which corresponds to the number on the Guided Drill Guide. Drill #2 (Ø2.0 Pilot) is used with the guided drill guide that has #2 printed on it. With those two markings, the Guided Drill Guides can be placed easily and quickly onto the correct position in the PureSet Tray.

NP 3.5
NP 3.75



RP 4.3



RP 5.0
WP 5.5



Straight drills for guided surgery

Guided drills are made of stainless steel with a diamond-like carbon (DLC) coating, which gives them their black color. They are used with external irrigation and are available in two lengths: 7-13 mm and 7-18 mm.

- Straight guided drills are used with external cooling.
- Prevent heat build-up and burning of bone by using an in-and-out motion in bone for 1–2 seconds.
- Guided drills are disposable and should be used for one surgery only. Do not resterilize disposable drills.
- In dense bone situations, drill with continuous back and forth motion.
- Move the drill up without stopping the handpiece motor. This allows the irrigation to flush away debris.
- Proceed until the desired depth reference line is reached.
- Guided screw taps are available for dense bone situations to avoid excessive torque during implant insertion (max. 45 Ncm).

Maximum speed 800 rpm

Tip During surgery maximum attention must be paid to ensure that the surgical template does not move in any direction from the correct position when being manipulated with instruments, e.g. lateral shift through inadequate handling of (pilot-)drills in 'knife-edge' situations or shift/deformation of surgical template due to excess vertical force application during implant installation.



Tips

- When using the guided twist drills, use copious irrigation and an in-and-out motion to avoid overheating.
- Stop drilling if there is no irrigation.
- Guided drills and guided screw taps are delivered sterile and are for single use only. Do not resterilize.

Caution Guided Twist/Step Drills are identified by the (10+) designation on the shaft. This indicates the drills are 10 mm longer than the "freehand" Twist/Step Drills to compensate for the height of the surgical template and the Guided Drill Guide. The depth marks on the Guided Twist/Step Drills correspond to 7, 10, and 13 mm implants for 7-13 mm drills and 7, 10, 13, 15 and 18 mm for 7-18 mm drills. The level should be measured with the Guided Drill Guide in place. Drills extend 1 mm longer than the implant when seated. Allow for this additional length when drilling near vital anatomical structures.

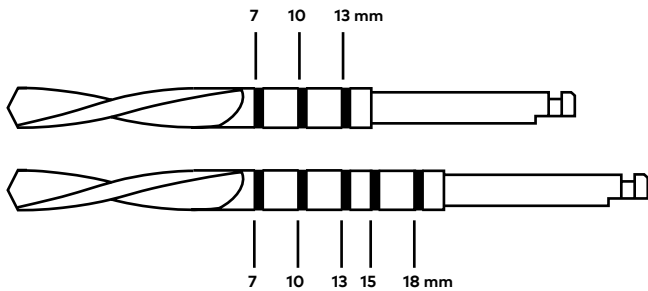
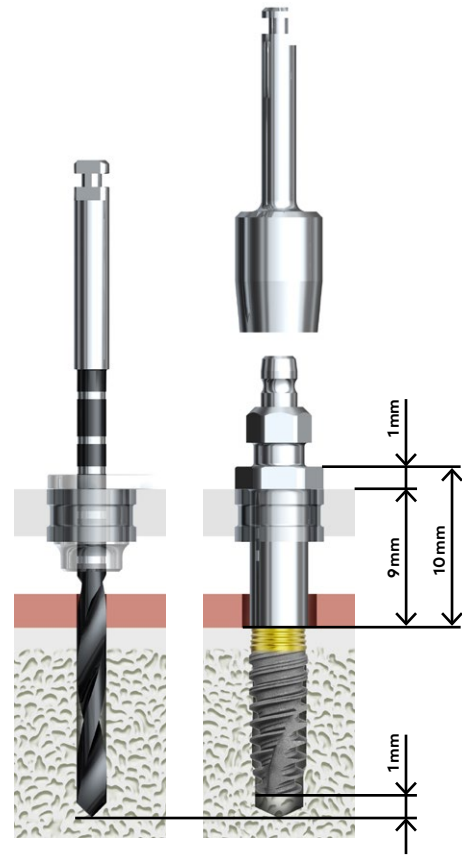

Tapered drills for guided surgery

- Guided tapered drills are both internally and externally irrigated to prevent heat build-up and burning of bone. Internal irrigation requires a specific technique to prevent irrigation holes becoming blocked with bone. Use an in-and-out motion while drilling in bone for 1–2 seconds.
- If an internal irrigation channel becomes blocked, remove the drill from the handpiece and clear hole using the Irrigation Needle (Art.No. 2042).
- Guided tapered drills are diameter- and length-specific.
- Guided tapered drills are reusable but should be replaced when cutting efficiency declines.

Maximum speed 800 rpm

Caution The Guided Tapered Drills are identified by the (+) designation on the shaft. The inbuilt depth stops on the Guided Tapered Drills correspond to the 8, 10, 11.5, 13, and 16 mm implants. This indicates the tapered drills are 9 mm longer than the non-guided instruments to compensate for the height of the surgical template's inbuilt guided sleeve. Drills extend up to 1 mm longer than the implant when seated.

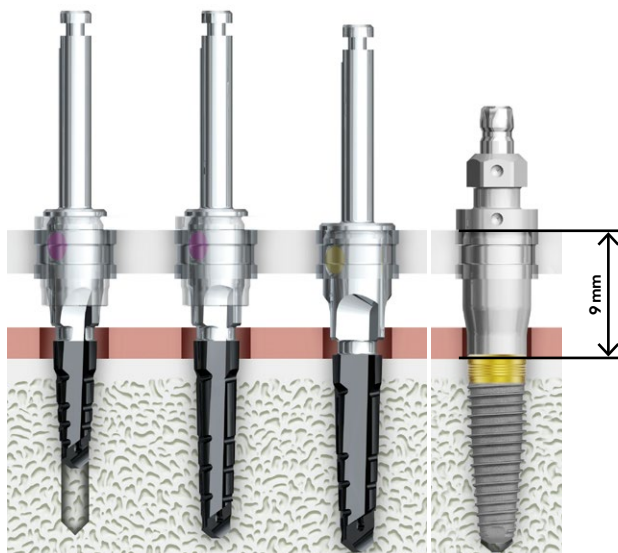

Drill stops for guided surgery

- Mount a drill stop on guided twist drills for a safe and accurate drilling procedure.
- Insert Guided Twist Drill with corresponding drill stop in a mounting hole with a depth corresponding to the planned depth of the osteotomy.
- Use the larger holes for drills \varnothing 3.4 and above.
- Tighten screw using a Unigrip Screwdriver.
- The drill stop is now mounted at a height where it serves as a hard stop when drilling the desired depth through a drill guide embedded in the surgical template.





Guided Start Drill
37152



- Guided Twist Step Drill**
- 10-15mm**
 - Ø1.5 Pilot (#1) 37397
 - 7-13 mm**
 - Ø2.0 Pilot (#2) 33107
 - Ø2.4/2.8 (#3) 35839
 - Ø2.8/3.2 (#4) 35840
 - Ø3.2/3.6 (#5) 35841
 - Ø3.8/4.2 (#6) 35842
 - Ø4.2/4.6 (#7) 35843
 - Ø4.2/5.0 (#8) 37934
 - 7-18 mm**
 - Ø2.0 Pilot (#2) 32746
 - Ø2.4/2.8 (#3) 35844
 - Ø2.8/3.2 (#4) 35875
 - Ø3.2/3.6 (#5) 35876
 - Ø3.8/4.2 (#6) 35877
 - Ø4.2/4.6 (#7) 38045
 - Ø4.2/5.0 (#8) 37945



Guided Twist Drill
Ø1.5 x 20mm
33066



Guided Anchor Pin
Ø1.5 mm
30909



Guided Anchor Pin
Ø1.5 mm short shaft
34761



Guided Tissue Punch
NP 37153
RP 37154
WP/6.0 (5.0) 37155
WP/6.0 (5.5) 38060

NobelActive® Guided PureSet™ Tray
PUR0600

NobelActive® Guided PureSet™

SINGLE USE ONLY

	Bone density	Soft	Medium	Dense
NP Ø3.5		2 (3) S	2 3 (4) S	2 3 4 S
RP Ø4.3		2 3 (4) S	2 3 5 S	2 3 5 (6) S
RP Ø5.0		2 3 5 S	2 3 5 6 S	2 3 5 6 (7) S
WP Ø5.5		2 3 5 (6) S	2 3 5 6 7 (8) S	2 3 5 6 8 S

(-) = only widen cortex
S = screw tap

A
Guided

Wallchart NobelActive® Guided PureSet™



Guided Drill Guide NP
#2: Article 32814
#3: Article 32817
#4: Article 35882

Guided Drill Guide RP 4.3
#2: Article 32815
#3: Article 32818
#4: Article 32822
#5: Article 35883
#6: Article 35884

Guided Drill Guide RP 5.0
#2: Article 32816
#3: Article 38046
#5: Article 35885
#6: Article 32825
#7: Article 35886

Guided Drill Guide WP
#8: Article 32826

Prosthetic Adapter
29167

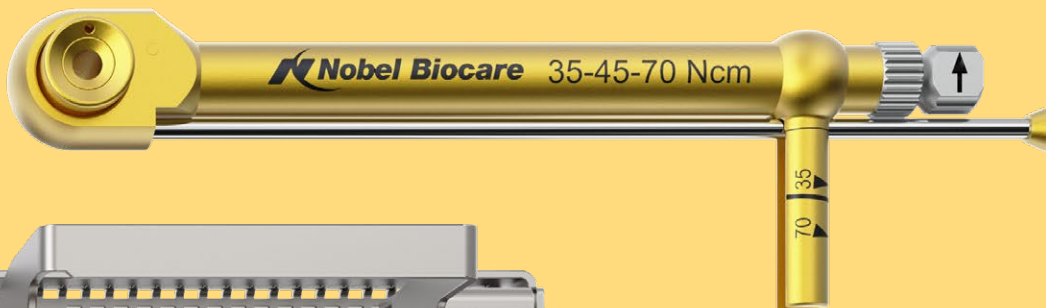

Surgical Torque
Wrench Manual
34584

Ø4.2/5.0
#8

Screw Tap 45 Ncm max
25 rpm

Implant Mount 70 Ncm max
25 rpm

Template Abutment

<p>Dense</p> <p>Dense</p> <p>Dense</p> <p>Dense</p>	<p>SINGLE USE ONLY</p>					
				<p>7-8.5</p> <p>10-15</p> <p>7-8.5 Dense</p> <p>10-15 Dense</p>	<p>Handpiece Connector</p>	<p>Screwdriver Unigrip</p>



Guided Implant Mount
NP 35887
RP Ø4.3 35888
RP Ø5.0 35889
WP Ø5.5 37948



Guided Template Abutment
NP 35890
RP Ø4.3 35891
RP Ø5.0 35892
WP Ø5.5 37949



Handpiece Connector
33065



Guided Screw Tap
NP Ø3.5 35878
RP Ø4.3 35879
RP Ø5.0 35880
WP Ø5.5 7-8.5 37946
WP Ø5.5 10-15 37947



Guided DB Screw Tap
NP Ø3.5 38179
RP Ø4.3 38180
RP Ø5.0 38181
WP Ø5.5 7-8.5 38182
WP Ø5.5 10-15 38183



Screwdriver Unigrip Machine
29151*



Screwdriver Unigrip Manual
29149*

*Article available in other lengths



Guided Start Drill
37152



Guided Twist Step Drill

- 7-13 mm**
 Ø2.0 Pilot (#2) 33107
 Ø2.4/2.8 (#3) 35839
 Ø2.8/3.2 (#4) 35840
 Ø3.2/3.6 (#5) 35841
 Ø3.8/4.2 (#6) 35842
 Ø4.2/4.6 (#7) 35843
 Ø4.2/5.0 (#8) 37934
- 7-18 mm**
 Ø2.0 Pilot (#2) 32746
 Ø2.4/2.8 (#3) 35844
 Ø2.8/3.2 (#4) 35875
 Ø3.2/3.6 (#5) 35876
 Ø3.8/4.2 (#6) 35877
 Ø4.2/4.6 (#7) 38045
 Ø4.2/5.0 (#8) 37945



Guided Twist Drill
Ø1.5 x 20mm
33066



Guided Anchor Pin
Ø1.5 mm
30909



Guided Anchor Pin
Ø1.5 mm short shaft
34761



Guided Tissue Punch
 NP 38059
 RP 37154
 WP/6.0 (5.0) 37155
 WP/6.0 (5.5) 38060

NobelParallel™ CC Guided PureSet™ Tray
PUR0700

NobelParallel™ CC Guided PureSet™

Anchor Pin 800 rpm max

Tissue Punch

Drill Guide 800 rpm max

NP Ø3.75

RP Ø4.3

RP Ø5.0

WP Ø5.5

P Guided

Bone density

	Soft	Medium	Dense
NP Ø3.75	2 [3]	2 3 C [S]	2 3 4 C S
RP Ø4.3	2 3 [5]	2 3 5 C [S]	2 3 5 C S
RP Ø5.0	2 3 5 [6]	2 3 5 6 C [S]	2 3 5 6 C S
WP Ø5.5	2 3 5 7 [8]	2 3 5 8 C [S]	2 3 5 8 C S

[-] = optional
 C = cortical drill
 S = screw tap

7 10 13 mm
 7 10 13 15 18 mm

Wallchart NobelParallel™ CC Guided PureSet™



Guided Drill Guide NP
 #2: Article 32814
 #3: Article 32817
 #4: Article 35882

Guided Drill Guide RP 4.3
 #2: Article 32815
 #3: Article 32818
 #5: Article 35883

Guided Drill Guide RP 5.0
 #2: Article 32816
 #3: Article 38046
 #5: Article 35885
 #6: Article 32825

Guided Drill Guide WP
 #7: Article 35886
 #8: Article 32826

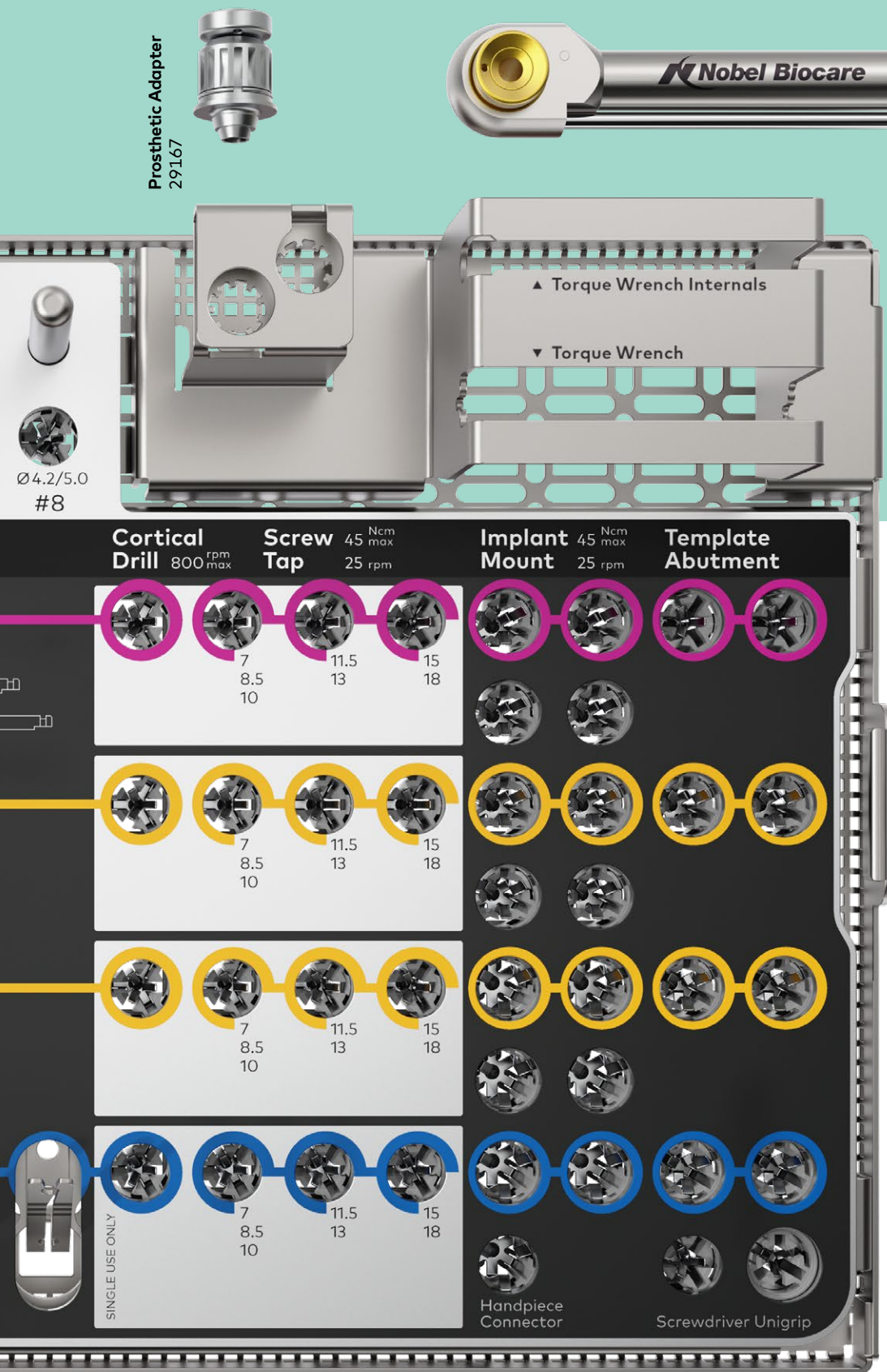

Surgical Torque Wrench Manual
28839

Guided Implant Mount
NP 38065
RP Ø4.3 38066
RP Ø5.0 38067
WP Ø5.5 38068

Guided Template Abutment
NP 38069
RP Ø4.3 37158
RP Ø5.0 37159
WP Ø5.5 38070

Unigrip Screwdriver Machine
29151*

Unigrip Screwdriver Manual
29149*

Handpiece Connector
33065

Guided Cortical Drill
NP Ø3.75 38061
RP Ø4.3 38062
RP Ø5.0 38063
WP Ø5.5 38064

Guided Screw Tap 7-10 mm
NP Ø3.75 38047
RP Ø4.3 38050
RP Ø5.0 38053
WP Ø5.5 38056

Guided Screw Tap 11.5-13 mm
NP Ø3.75 38048
RP Ø4.3 38051
RP Ø5.0 38054
WP Ø5.5 38057

Guided Screw Tap 15-18 mm
NP Ø3.75 38049
RP Ø4.3 38052
RP Ø5.0 38055
WP Ø5.5 38058

*Article available in other lengths

Guided Start Drill
37152



Guided Twist Drill Ø2 mm
36123



Guided Tapered Drill 8 mm
NP Ø3.5 32827
RP Ø4.3 32831
WP Ø5.0 32835



Guided Tapered Drill 10 mm
NP Ø3.5 32828
RP Ø4.3 32832
WP Ø5.0 32836



Guided Tapered Drill 11.5 mm
NP Ø3.5 36119
RP Ø4.3 36120
WP Ø5.0 36121



Guided Tapered Drill 13 mm
NP Ø3.5 32829
RP Ø4.3 32833
WP Ø5.0 32837



Guided Twist Drill Ø1.5 x 20mm
33066



Guided Anchor Pin Ø1.5 mm
30909



Guided Anchor Pin
Ø1.5 mm short shaft
34761



Guided Tissue Punch
NP 37153
RP 37154
WP/6.0 (5.0) 37155

NobelReplace® CC Guided
PureSet™ Tray
PUR0800

NobelReplace® CC Guided PureSet™

Anchor Pin 800 rpm max

Tissue Punch

Tapered Drill 800 rpm max

Drill Guide

R Guided

Diagram details: The tray contains various drill bits and guides. On the left, there are three rows of drill bits: NP Ø3.5 (pink), RP Ø4.3 (yellow), and RP Ø5.0 (blue). In the center, there are two rows of tissue punches: NP Ø3.5 (pink) and RP Ø4.3 (yellow). On the right, there are two rows of tapered drills: NP Ø3.5 (pink) and RP Ø4.3 (yellow). At the bottom, there are five rows of drill guides: NP Ø3.5 (pink), RP Ø4.3 (yellow), and WP Ø5.0 (blue). The tray also features a 'Drill Guide' section with five guides labeled #2, #2, #3, #2, #3, #4. A 'Drill Pin Anchor Pin' is shown at the top left. A 'Guided Twist Drill Ø1.5 x 20mm 33066' is shown at the top left. A 'Guided Start Drill 37152' is shown at the top left. A 'Guided Twist Drill Ø2 mm 36123' is shown at the top left. A 'Guided Tapered Drill 8 mm' is shown at the top left. A 'Guided Tapered Drill 10 mm' is shown at the top left. A 'Guided Tapered Drill 11.5 mm' is shown at the top left. A 'Guided Tapered Drill 13 mm' is shown at the top left.

Wallchart NobelReplace® CC Guided PureSet™

Guided Drill Guide
NP #2: Article 32814



RP #2: Article 32815



RP #3: Article 33018



WP #2: Article 32816



WP #3: Article 33019



WP #4: Article 33020



Guided Tapered Drill 16 mm
 NP Ø3.5 32830
 RP Ø4.3 32834
 WP Ø5.0 32838

Prosthetic Adapter
 29167



Manual Torque Wrench Surgical
 28839

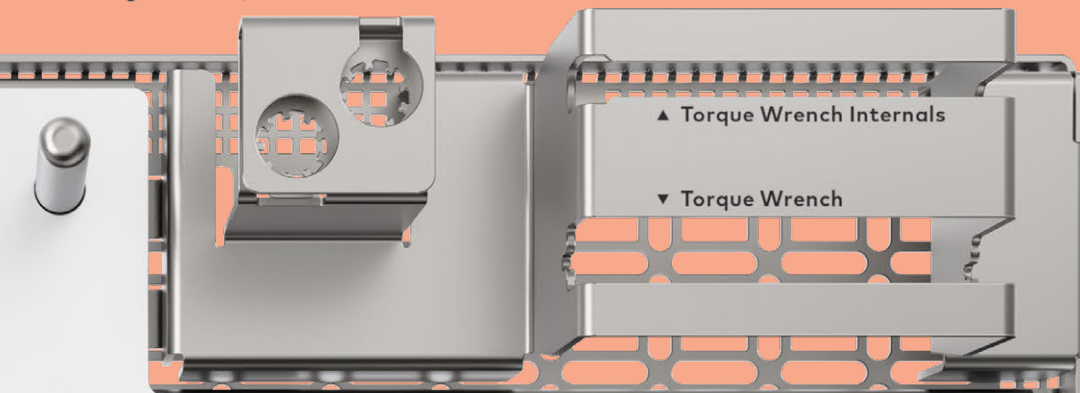

Optional Tool

Dense Bone Drill 800 rpm max



Screw Tap 45 Ncm max 25 rpm



Cortical Drill 800 rpm max



Handpiece Connector

Screwdriver Unigrip

Implant Mount 45 Ncm max 25 rpm

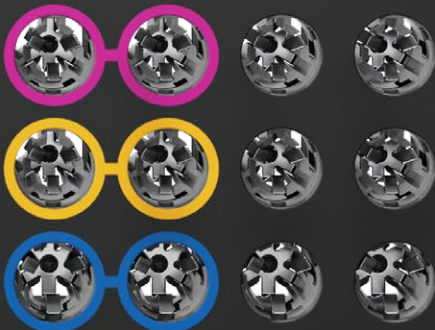

Template Abutment



Handpiece Connector
 33065



Unigrip Screwdriver Machine
 29151*



Screwdriver Unigrip Manual
 29149*



Guided Implant Mount
 NP 3.5 37149
 RP 4.3 37150
 WP 5.0 37151



Guided Template Abutment
 NP 3.5 37157
 RP 4.3 37158
 WP 5.0 37159

Guided DB Drill 13 mm
 NP Ø3.5 32844
 RP Ø4.3 32847
 WP Ø5.0 32850

Guided DB Drill 16 mm
 NP Ø3.5 32845
 RP Ø4.3 32848
 WP Ø5.0 32851

Guided Screw Tap
 NP Ø3.5 37171
 RP Ø4.3 32858
 WP Ø5.0 32860

Guided Cortical Drill
 NP Ø3.5 37167
 RP Ø4.3 37168
 WP Ø5.0 37169

*Article available in other lengths

NobelActive® Guided PureSet™ 87305

(The articles below can also be purchased individually)

NobelActive Guided PureSet Tray	PUR0600
Guided Anchor Pin Ø1.5 mm	30909
Handpiece Connector	33065
Screwdriver Manual Unigrip 28 mm	29149
Screwdriver Machine Unigrip 20 mm	29151
Manual Torque Wrench Adapter Prosthetic	29167
NobelActive Manual Torque Wrench Surgical	34584
NobelActive Guided PureSet Wall Chart	301165
Guided Drill Guide NP Ø2.0	32814
Guided Drill Guide NP Ø2.8	32817
Guided Drill Guide NP Ø3.2	35882
Guided Drill Guide RP Ø2.0	32815
Guided Drill Guide RP Ø2.8	32818
Guided Drill Guide RP Ø3.2	32822
Guided Drill Guide RP Ø3.6	35883
Guided Drill Guide RP Ø4.2	35884
Guided Implant Mount NP	35887
Guided Implant Mount RP	35888
Guided Template Abutment NP	35890
Guided Template Abutment RP	35891
Guided Tissue Punch NP	37153
Guided Tissue Punch RP	37154

Tip All other necessary tooling (e.g. Drills and Screw Taps) are available for separate purchase.

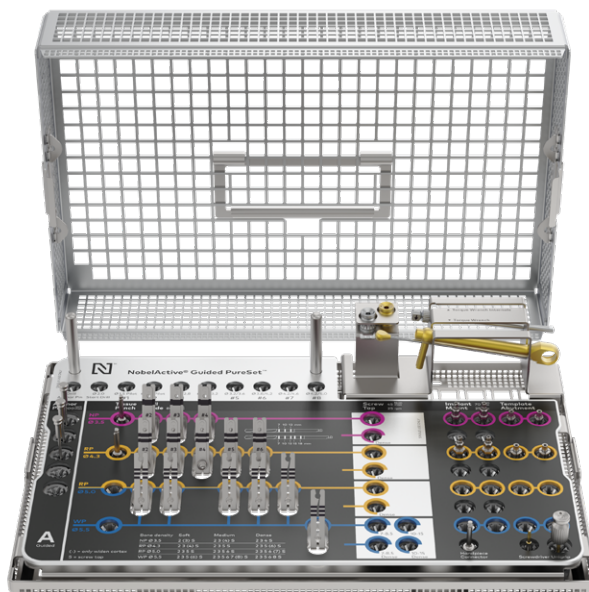

For more information regarding the product portfolio see the 'Product Overview - PureSet'.

NobelParallel™ CC Guided PureSet™ 87306

(The articles below can also be purchased individually)

NobelParallel Guided PureSet Tray	PUR0700
Guided Anchor Pin Ø1.5 mm	30909
Handpiece Connector	33065
Screwdriver Manual Unigrip 28 mm	29149
Screwdriver Machine Unigrip 20 mm	29151
Manual Torque Wrench Adapter Prosthetic	29167
Manual Torque Wrench Surgical	28839
NobelParallel CC Guided PureSet Wall Chart	301166
Guided Drill Guide NP Ø2.0	32814
Guided Drill Guide NP Ø2.8	32817
Guided Drill Guide NP Ø3.2	35882
Guided Drill Guide RP Ø2.0	32815
Guided Drill Guide RP Ø2.8	32818
Guided Drill Guide RP Ø3.6	35883
Guided Implant Mount NP	38065
Guided Implant Mount RP	38066
Guided Template Abutment NP	38069
Guided Template Abutment RP	37158
Guided Tissue Punch NP	38059
Guided Tissue Punch RP	37154

Tip All other necessary tooling (e.g. Drills and Screw Taps) are available for separate purchase.

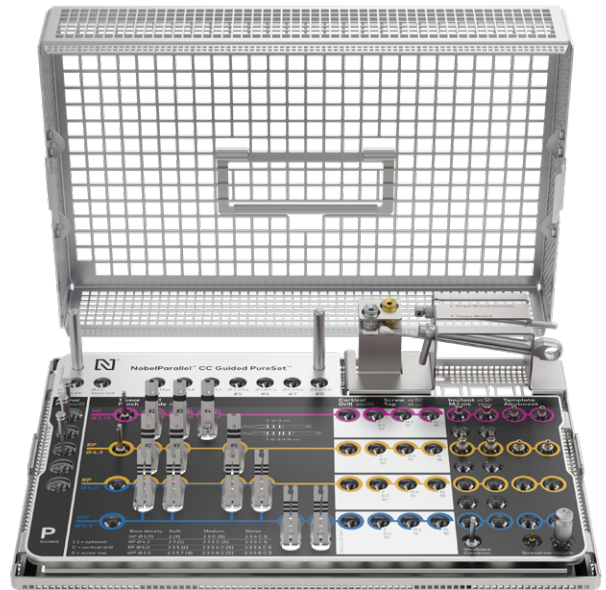

For more information regarding the product portfolio see the 'Product Overview - PureSet'.

NobelReplace® CC Guided PureSet™ 87307

(The articles below can also be purchased individually)

NobelReplace CC Guided PureSet Tray	PUR0800
Guided Anchor Pin Ø1.5 mm	30909
Handpiece Connector	33065
Screwdriver Manual Unigrip 28 mm	29149
Screwdriver Machine Unigrip 20 mm	29151
Manual Torque Wrench Adapter Prosthetic	29167
Manual Torque Wrench Surgical	28839
NobelReplace CC Guided PureSet Wall Chart	301167
Guided Drill Guide NP Ø2.0	32814
Guided Drill Guide RP Ø2.0	32815
Guided Drill Guide RP Ø2.8	32818
Guided Drill Tapered NP 8 mm	32827
Guided Drill Tapered NP 10 mm	32828
Guided Drill Tapered NP 11.5 mm	36119
Guided Drill Tapered NP 13 mm	32829
Guided Drill Tapered NP 16 mm	32830
Guided Drill Tapered RP 8 mm	32831
Guided Drill Tapered RP 10 mm	32832
Guided Drill Tapered RP 11.5 mm	36120
Guided Drill Tapered RP 13 mm	32833
Guided Drill Tapered RP 16 mm	32834
Guided Dense Bone Drill Tapered NP 13 mm	32844
Guided Dense Bone Drill Tapered NP 16 mm	32845
Guided Dense Bone Drill Tapered RP 13 mm	32847
Guided Dense Bone Drill Tapered RP 16 mm	32848
Guided Screw Tap Tapered NP	37171
Guided Screw Tap Tapered RP	32858
Guided Implant Mount NP	37149
Guided Implant Mount RP	37150
Guided Template Abutment NP	37157
Guided Template Abutment RP	37158
Guided Tissue Punch NP	37153
Guided Tissue Punch RP	37154

Tip All other necessary tooling (e.g. Drills and Screw Taps) are available for separate purchase.

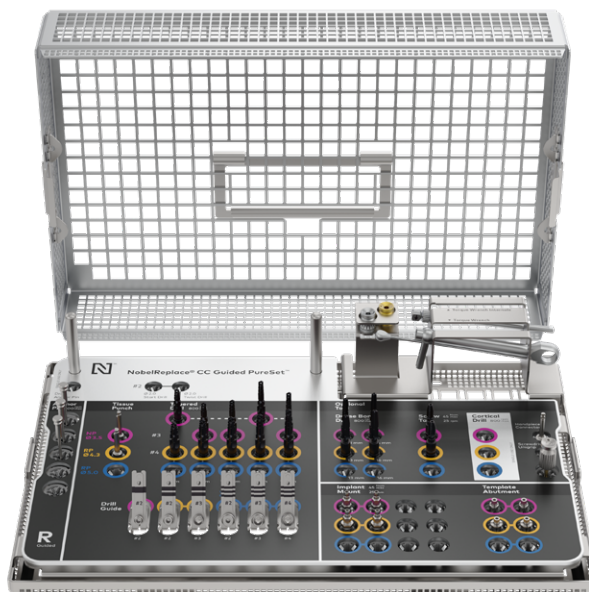

For more information regarding the product portfolio see the 'Product Overview - PureSet'.

Guided drilling and implant placement NobelActive® TiUltra™



Technical specifications

The unique thread design of NobelActive TiUltra implants allows for redirection of the implant during insertion. This feature has been taken into consideration in the drilling protocol for placing NobelActive TiUltra implants in conjunction with the NobelGuide surgical template.

Caution Never exceed insertion torque of 45 Ncm for a NobelActive TiUltra 3.0 implant and 70 Ncm for NobelActive TiUltra 3.5, 4.3, 5.0 and 5.5 implants. Overtightening an implant may lead to damage of the implant, fracture or necrosis of the bone site. If a Surgical Driver is used to insert the implant, special care needs to be taken to avoid overtightening.

Drill sequence

Demonstration of the guided drill protocol for a $\varnothing 4.3 \times 13$ mm implant in soft, medium and dense bone.



Soft bone

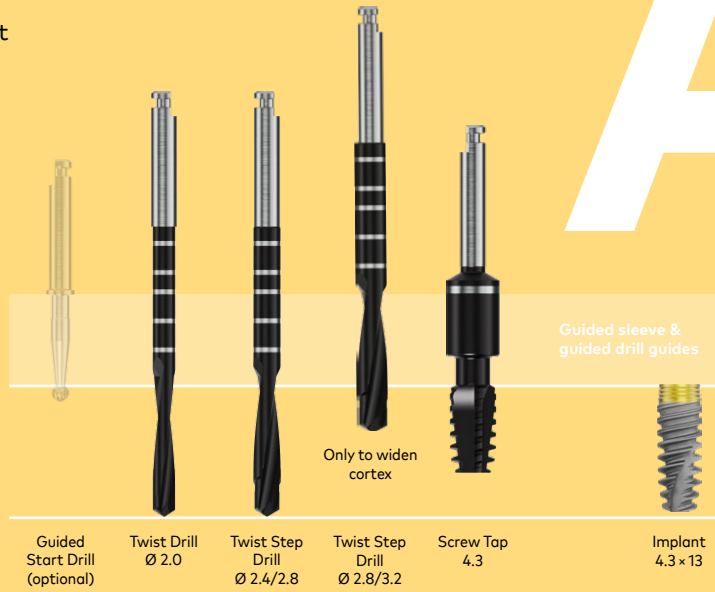

Medium bone

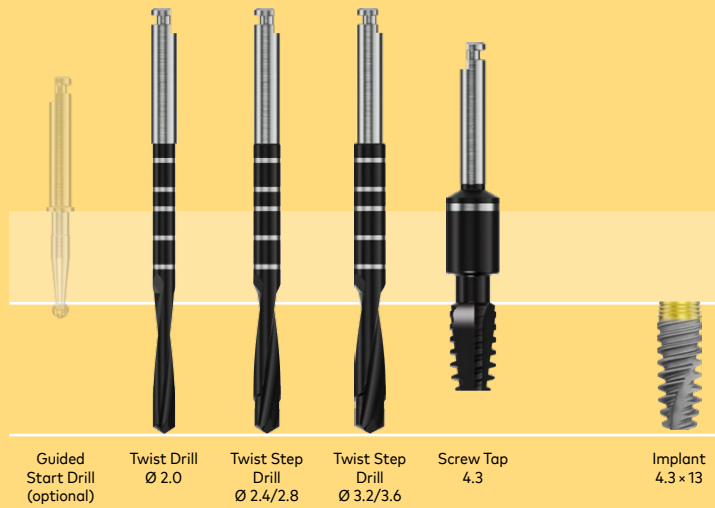

Dense bone

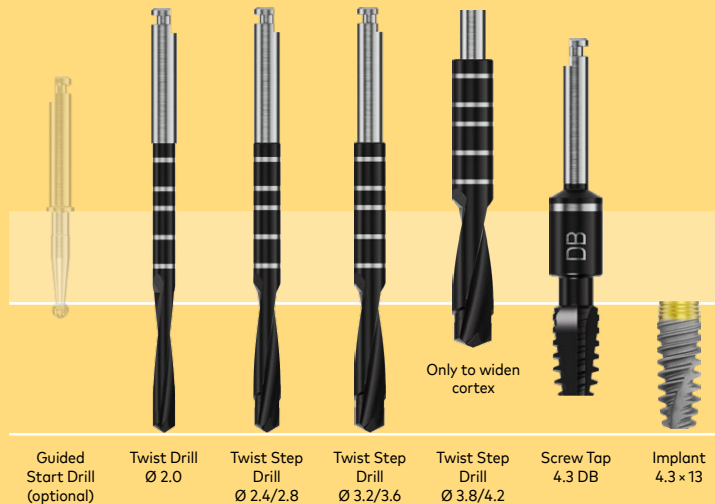

Recommended drill sequence based on bone quality*

Recommended to ensure optimal primary implant stability when planning for Immediate Function.

Platform	Soft Bone Type IV	Medium Bone Type II-III	Dense Bone Type I
NP 3.5	2.0 (2.4/2.8) Screw Tap 3.5	2.0 2.4/2.8 (2.8/3.2) Screw Tap 3.5	2.0 2.4/2.8 2.8/3.2 Screw Tap 3.5 DB
RP 4.3	2.0 2.4/2.8 (2.8/3.2) Screw Tap 4.3	2.0 2.4/2.8 3.2/3.6 Screw Tap 4.3	2.0 2.4/2.8 3.2/3.6 (3.8/4.2) Screw Tap 4.3 DB
RP 5.0	2.0 2.4/2.8 3.2/3.6 Screw Tap 5.0	2.0 2.4/2.8 3.2/3.6 3.8/4.2 Screw Tap 5.0	2.0 2.4/2.8 3.2/3.6 3.8/4.2 (4.2/4.6) Screw Tap 5.0 DB
WP 5.5	2.0 2.4/2.8 3.2/3.6 (3.8/4.2) Screw Tap 5.5	2.0 2.4/2.8 3.2/3.6 3.8/4.2 4.2/4.6 (4.2/5.0) Screw Tap 5.5	2.0 2.4/2.8 3.2/3.6 3.8/4.2 4.2/5.0 Screw Tap 5.5 DB

Tip All data is stated in millimeters.
Drills within brackets (-) denote widening of the cortex only, not drilling to the full drilling depth.

During drilling procedures bone quality should be considered. Refer to the table above, which presents the recommended drill sequences based on bone quality to ensure optimal primary stability when applying immediate function.

The recommended drill sequences are based on bone quality. Drill data are stated in mm and the drill diameters listed within brackets denote widening of cortex only.

Drilling must proceed at high speed (max. 2000 rpm for Precision/Twist/Twist Step Drills) under constant and profuse external irrigation by sterile saline at room temperature.

There is no fully guided protocol for NobelActive TiUltra 3.0 available. Please refer to [page 68](#).

* According to classification by Lekholm U, Zarb GA. Patient selection and preparation. In: Brånemark PI, Zarb GA, Albrektsson T, editors: Tissue-integrated prostheses: Osseointegration in clinical dentistry. Quintessence, Chicago, 1985, pp 199-209.

Preparation of the osteotomy

- Use an in-and-out motion and drill for 1–2 seconds.
- Move the drill up without stopping the handpiece motor. This allows the irrigation to flush away debris.
- Proceed until the desired depth reference line is reached.
- Drills within brackets (-) denote widening of the cortex only, not drilling to full depth.

Procedure for implant placement in dense bone

- If the implant gets stuck during implant installation, or the maximum torque is achieved before fully seated one of the following procedures should be followed:
 - a) Rotate the implant counterclockwise for a few turns enabling the use of the self-tapping capacity of the implant; or
 - b) Back out implant and widen the site with a wider drill according to drill protocol; or select a NobelActive screw tap which matches the diameter of the implant and desired drilling depth:
 - Place the screw tap into prepared implant site using low speed (25 rpm).
 - Apply firm pressure and begin rotating the screw tap slowly. When the threads engage, continue to thread the screw tap to the defined depth without applying additional pressure.
 - Switch the drill unit with handpiece to reverse mode and back the screw tap out.

Mandatory Guided Screw Taps

Guided screw tapping is mandatory and has the following aims:

Securing insertion precision

For guided insertion of the NobelActive TiUltra implant, the correct starting point is crucial. The dedicated guided screw taps for soft/medium and dense bone are mandatory for all indications. They define the correct insertion point for precise implant placement. Early steering means the Guided Screw Tap engages with the Guided Sleeve before encountering bone. Tapping of just two or three threads (height of cortical bone) may be enough in soft bone.

Avoid early bone contact

Warning Avoid early bone contact before using the screw tap, the shape of the crest should be checked to avoid early collision between the upper half of the screw tap (with the largest diameter) and the bone. This might block the screw tap and jeopardize site preparation. Remove the bone to allow insertion of the screw tap.

Accurate implant placement following the pre-tapped path

First, rotate the implant counterclockwise using the surgical adapter until the implant falls into the pre-tapped thread. Then rotate the implant clockwise into the pre-tapped path. This technique ensures that the implant is placed accurately with zero friction between sleeve and implant, which enables precise torque measurements.

Place implant subcrestally without removing additional bone

Designed to complement the unique characteristics of NobelActive, the diameter of the Guided Implant Mount is identical to the implant shoulder, allowing for subcrestal placement without removing additional bone on the neighboring crest. The Guided Implant Mount includes a precise vertical stop. Visual control of implant installation through the sleeve is required during the full insertion procedure.

Guided Implant Mount NobelActive

	NP	RP 4.3	RP 5.0	WP 5.5
Guided sleeve (A)	Ø 4.11	Ø 5.02	Ø 6.22	Ø 6.22
Implant mount (B)	Ø 3.52	Ø 3.90	Ø 3.90	Ø 5.08
Diameter difference	0.59	1.12	2.32	1.14

All measurements in millimeters.

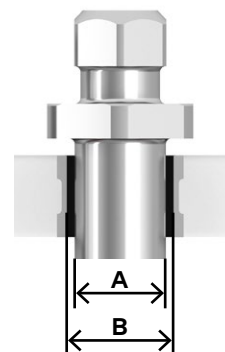

Note The Guided Implant Mount NobelActive includes a vertical stop. The implant mount body has the same outer diameter as the implant platform and therefore is smaller than that of the guided sleeve in the template sleeve (see table and figure). This makes it possible to plan and place the implants

sub-crestally without the removal of additional bone on the neighboring crest only to allow for the implant mount diameter to pass. Additionally, this allows for measuring real clinical torque values between implant and bone.

Drilling sequence

The following procedure and illustrations show the use of NobelActive RP 4.3 × 13 mm (for drilling protocols in all bone situations, see [page 89](#)). For further information, please refer to Instructions For Use NobelActive and NobelGuide.

1 Drill with Guided Start Drill

- Start drilling one implant first, from start to finish, including guided implant insertion.
- Place the Guided Drill Guide RP to Ø 2 mm in the first RP template sleeve.
- Drill with the Guided Start Drill to the built-in drill stop.

Maximum speed 800 rpm

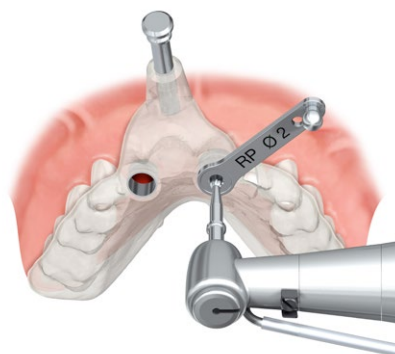

2 Drill with Guided Twist Drill

- Mount a Drill Stop Ø 2mm on the Guided Twist Drill Ø 2 x (10+) 7-18mm (optionally use the Guided Twist Drill Ø 2.0 x (10+)7-13 mm)
- Drill with the Guided Twist Drill to the desired depth under profuse irrigation using the drill guide for guidance.
- Proceed with the same protocol for the remaining drill sizes, Ø 2.4/2.8 and Ø 3.2/3.6.

Maximum speed 800 rpm

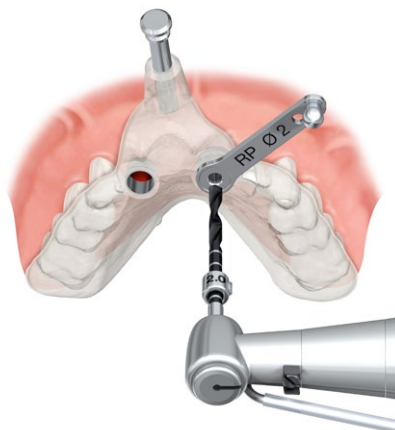
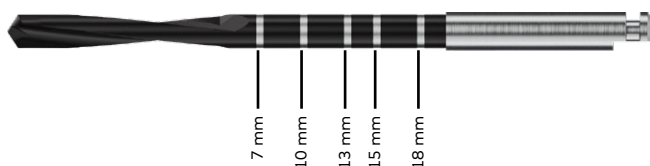

3 Mandatory screw tapping

- Place the Guided Screw Tap NobelActive RP 8.5–10 mm directly in the sleeve and prepare the site to the desired depth at low speed (20–45 Ncm) and with copious irrigation.
- The depth markings on the screw tap correspond to full depth tapping of 8.5 and 10 mm implants. The screw tap should not be inserted deeper than the second laser mark.
- Carefully remove the screw tap to make sure the site preparation is not damaged.

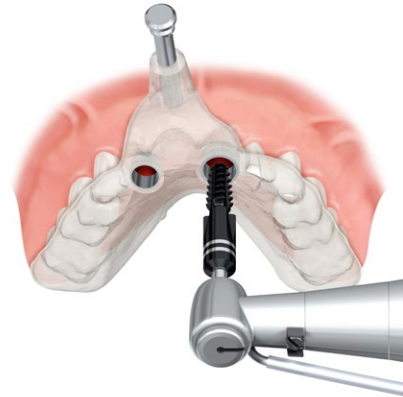

Low speed 25 rpm Maximum torque 45 Ncm



Guided Screw Tap (mandatory soft/
medium bone)



Guided Dense Bone Screw Tap (mandatory
dense bone)

Note Depth of tapping using the Guided Screw Tap or Guided Dense Bone Screw Tap will depend on the bone quality. Tapping of just two to three threads (height of cortical bone) may be sufficient. Always consider tapping to full depth may not be possible due to anatomical constraints.

4 Open implant package

- Open the outer packaging of the implant.
- Peel off the sealed blister lid in order to open it and allow the plastic vial on the sterile field.
- Unscrew the lid and take out the sterile titanium vial, lift off the color-coded titanium vial cap to gain access to the implant.



5 Connect implant to implant mount

- Connect the Guided Implant Mount NobelActive RP 4.3 to the implant using a Unigrip Screwdriver and the surgical adapter from the Manual Torque Wrench.
- Make sure that the implant mount is fully seated on the shoulder of the implant platform.



Tip Do not use another Guided Implant Mount than the Guided Implant Mount NobelActive.



6 Pick up mounted implant

Pick up the mounted implant with the surgical adapter holding it with two fingers.

7 Manual implant insertion

- Perform the first turns of the insertion by hand. Start with a gentle turn counterclockwise until you can feel the implant falling into the pre-tapped thread.
- Then turn clockwise into the pre-tapped path. This technique makes it easier to find the correct pre-tapped path and optimizes the accuracy of the implant placement.

Tip Visually check that the implant mount is kept in the center of the guided sleeve during the entire insertion process.

Alternative Use the connection to handpiece for installation by machine, starting at 30 Ncm. As the insertion of the NobelActive implant goes quickly, a very slow rotational speed is recommended. Using the machine compromises the tactile feedback for initial placement. The use of the machine for initial placement is only indicated if mouth opening or access (posterior region) does not allow for manual initial placement.

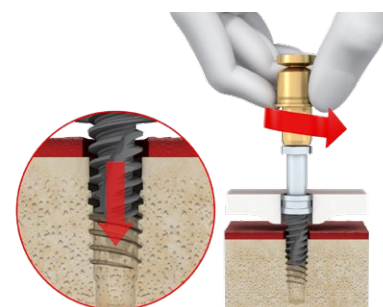

Gently turn counterclockwise first

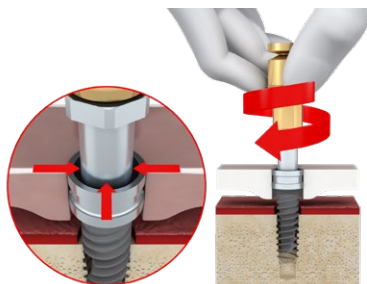

Turn clockwise into the pre-tapped path

Guided implant placement – partially edentulous

8 Insert implant with machine

- Remove the surgical adapter and continue with implant insertion with the Connection to Handpiece and drilling unit. NobelActive TiUltra implants must be installed with low speed, maximum 25 rpm using the drilling unit.
- For final implant insertion, use the Manual Torque Wrench to avoid implant overtightening. The maximum insertion torque for the implant is 70 Ncm for NobelActive TiUltra Ø 3.5, Ø 4.3, Ø 5.0, and Ø 5.5 implants and may be measured with the NobelActive Manual Torque Wrench Surgical. Please refer to [page 68](#) for NobelActive TiUltra 3.0 placement.
- Stop tightening the implant when the Guided Implant Mount touches the surgical template.

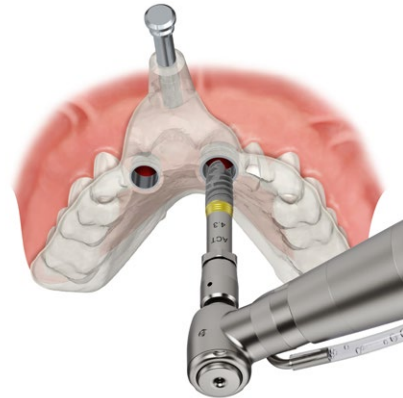

Low speed 25 rpm Maximum torque 70 Ncm

Caution Never exceed insertion torque of 70 Ncm for NobelActive Ø 3.5, Ø 4.3, Ø 5.0, and Ø 5.5 implants. Overtightening an implant may lead to damage of the implant, fracture or necrosis of the bone site.

9 Anchor the surgical template

- Use the Guided Template Abutment NobelActive RP 4.3.
- Tighten manually using a Unigrip Screwdriver.
- Ensure that the surgical template stays in its initial correct position for the next implant site preparation.

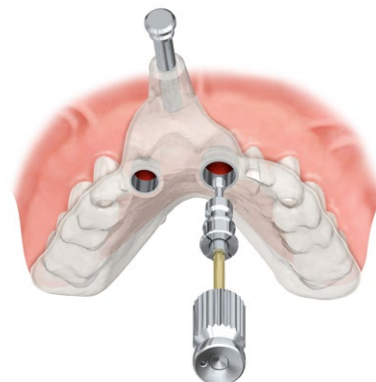

10 Place remaining implants

- Proceed with preparation of the remaining implant sites.
- Install the remaining implants according to the previously described procedures.

Tips

- Place Guided Template Abutments on the first two implants. After placement, leave the Guided Implant Mounts seated in their final position until all implants are placed.
- If only two implants are to be placed, there is no need for a Guided Template Abutment on the second implant.

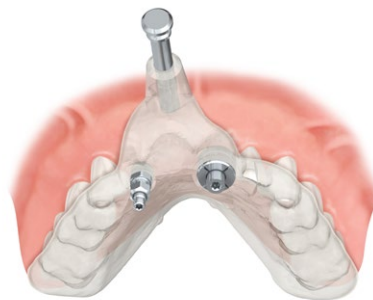

11 Remove surgical template

- Once all implants are installed, remove the Guided Implant Mounts and Guided Template Abutments using the Unigrip Screwdriver.
- Remove the anchor pins and the surgical template.



Guided implant placement – edentulous

8 Insert the first mounted implant

Remove the surgical adapter and continue with implant insertion with the Connection to Handpiece and drilling unit. NobelActive TiUltra implants must be installed with low speed, maximum 25 rpm using the drilling unit.

9 Insert the first mounted implant

- Insert the first implant (for example in the canine position) until the flange of the Guided Implant Mount is 1 mm short of the outer surface of the surgical template sleeve.
- Leave the Guided Implant Mount in place.

Low speed 25 rpm Maximum torque 70 Ncm

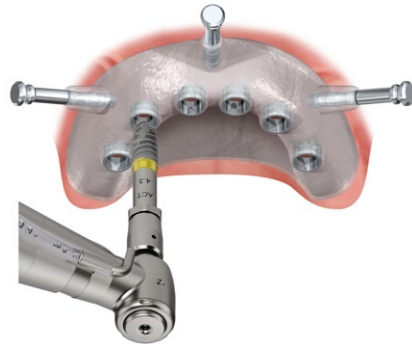

10 Insert the second mounted implant

- Choose the implant site strategically placed in the middle of the opposite half of the arch to obtain proper distribution.
- Prepare and insert the second implant until the flange of the Guided Implant Mount is 1 mm short of the outer surface of the surgical template sleeve.

Low speed 25 rpm Maximum torque 70 Ncm

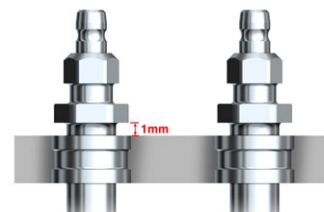
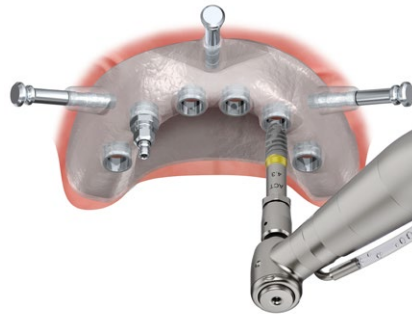

11 Finalize implant insertion

- Remove the Connection to Handpiece.
- Using the NobelActive Manual Torque Wrench Surgical, carefully seat the first and second implant until the flange of the Guided Implant Mount slightly touch the surgical template sleeve.

Maximum torque 70 Ncm

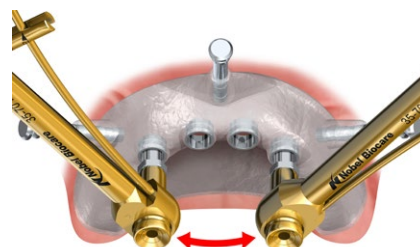

Tip Follow the described protocol to minimize the risk of over-torquing and to minimize movement of the surgical template.

12 Anchor the surgical template

- Use the Unigrip Screwdriver to remove the Guided Implant Mount.
- Place a Guided Template Abutment NobelActive RP 4.3 onto each of the seated implants.
- Tighten manually using the Unigrip Screwdriver.
- Ensure that the surgical template maintains its initial correct position for the following implant site preparation.

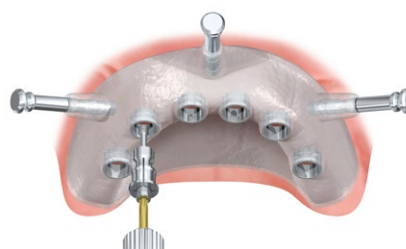

13 Install remaining implants

- Proceed with preparation of the remaining implant sites (steps 1 - 6, [page 92](#)).
- Install the remaining implants until the flange of the Guided Implant Mount touches the top of the guided sleeve in the surgical template.

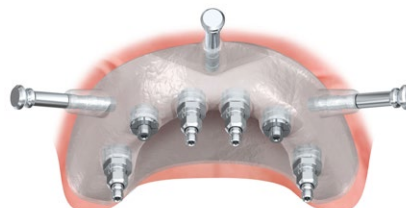

Tip Place the Guided Template Abutments on the first two implants. After placement, leave the seated Guided Implant Mounts in their final position until all implants are placed.

14 Remove surgical template

- Once all implants are installed, remove the Guided Implant Mounts and Guided Template Abutments using the Unigrip Screwdriver.
- Remove the anchor pins and the surgical template.



Guided drilling and implant placement

NobelParallel™ CC TiUltra™



Technical specifications

NobelParallel CC TiUltra is an endosseous threaded dental implant made from biocompatible commercially pure grade 4 titanium with TiUltra surface.

Cautions

- Guided Twist/Step Drills are identified by the (10+) designation on the shaft. This indicates the drills are 10 mm longer than the "freehand" Twist/Step Drills to compensate for the height of the surgical template and the Guided Drill Guide. The depth marks on the Guided Twist/Step Drills correspond to 7, 10, and 13 mm implants for 7–13 mm drills and 7, 10, 13, 15 and 18 mm for 7–18 mm drills. The level should be measured with the Guided Drill Guide in place. Drills extend 1 mm longer than the implant when seated. Allow for this additional length when drilling near vital anatomical structures.
- Never exceed insertion torque of 45 Ncm for NobelParallel CC Implants. Overtightening an implant may lead to damage of the implant, fracture or necrosis of the bone site.

Optional Drills

If bone density is inconsistent (varying between medium and soft or medium and dense bone), optional drills can be added to the drill protocol to ensure the torque level does not exceed 45 Ncm. It is recommended that the Guided Counterbore (Cortical Drill) NobelParallel CC (single use) is used in medium and dense bone (maximum 800 rpm) to create adequate access for the Guided Screw Tap and/or Guided Implant Mount. The dense bone protocol is to be used when the implant cannot be fully seated.



P

Drill sequence

Demonstration of the guided drill protocol for a $\varnothing 4.3 \times 13$ mm implant in soft, medium and dense bone.

Soft bone

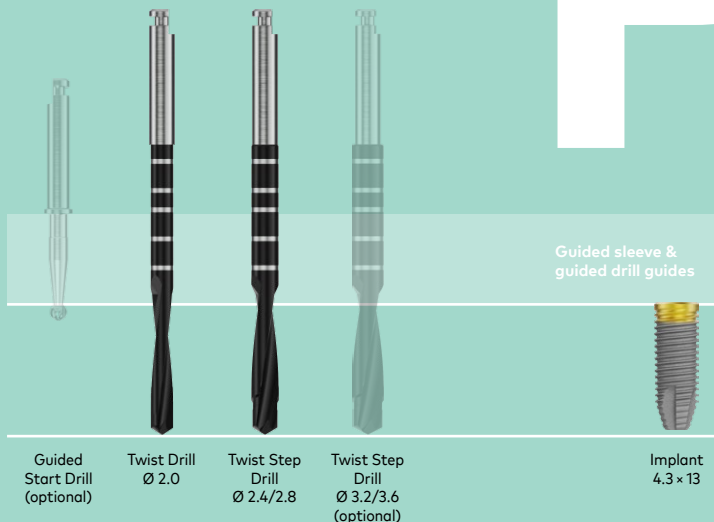

Medium bone

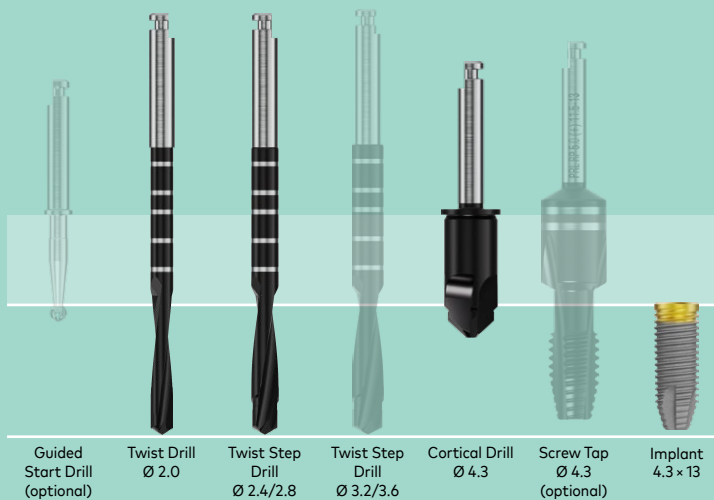

Dense bone



Drill protocols according to bone quality

During drilling procedures bone quality should be considered. Recommended drill sequences are based on bone quality to ensure optimal primary stability when applying Immediate Function. Drills are used to the full drilling depth.

Drilling must proceed at high speed (max. 2000 rpm for Twist Drills and Twist Step Drills) under constant and profuse irrigation by sterile saline at room temperature.

Platform	Soft bone Type IV	Medium bone Type II–III	Dense bone Type I
NP 3.75	2.0 [2.4/2.8]	2.0 2.4/2.8 Cortical Drill 3.75 [Screw Tap 3.75]	2.0 2.4/2.8 2.8/3.2 Cortical Drill 3.75 Screw Tap 3.75
RP 4.3	2.0 2.4/2.8 [3.2/3.6]	2.0 2.4/2.8 3.2/3.6 Cortical Drill 4.3 [Screw Tap 4.3]	2.0 2.4/2.8 3.2/3.6 Cortical Drill 4.3 Screw Tap 4.3
RP 5.0	2.0 2.4/2.8 3.2/3.6 [3.8/4.2]	2.0 2.4/2.8 3.2/3.6 3.8/4.2 Cortical Drill 5.0 [Screw Tap 5.0]	2.0 2.4/2.8 3.2/3.6 3.8/4.2 Cortical Drill 5.0 Screw Tap 5.0
WP 5.5	2.0 2.4/2.8 3.2/3.6 4.2/4.6 [4.2/5.0]	2.0 2.4/2.8 3.2/3.6 4.2/5.0 Cortical Drill 5.5 [Screw Tap 5.5]	2.0 2.4/2.8 3.2/3.6 4.2/5.0 Cortical Drill 5.5 Screw Tap 5.5

Tip All data are in mm and the drills within square brackets denoted as optional.

Optional drills

The drill protocol has been developed to achieve an implant insertion torque between 35 and 45 Ncm for all bone densities. This is to ensure sufficient primary stability to enable Immediate Function where appropriate.

If bone density is inconsistent (varying between medium and soft or medium and dense bone), optional drills can be added to the drill protocol to ensure the torque level does not exceed 45 Ncm. These optional Twist Step Drills and Screw Taps are denoted above in parentheses.

Caution Never exceed insertion torque of 45 Ncm for NobelParallel CC implants. Overtightening an implant may lead to damage of the implant, fracture or necrosis of the bone site.

Drilling sequence

The following procedure and illustrations show the use of NobelParallel CC RP 4.3 × 13 mm. For further information, please refer to Instructions For Use NobelParallel CC and NobelGuide.

1 Drill with Guided Start Drill

- Start drilling one implant first, from start to finish, including guided implant insertion.
- Place the Guided Drill Guide RP to Ø 2 mm in the first RP template sleeve.
- Drill with the Guided Start Drill to the built-in drill stop.

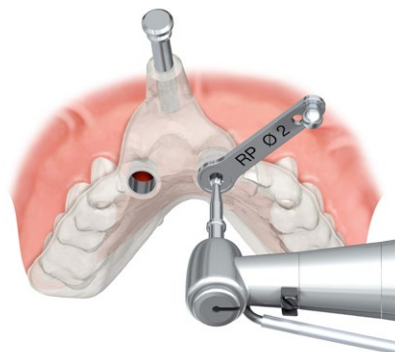

Maximum speed 800 rpm



2 Drill with Guided Twist Drill

- Mount a Drill Stop Ø 2 mm on the Guided Twist Drill Ø 2 x (10+) 7-18 mm (optionally use the Guided Twist Drill Ø 2.0 x (10+)7-13 mm) for a safe and accurate drilling procedure.
- Place the Guided Drill Guide RP to Ø 2 mm in the selected template sleeve.
- Drill with the Guided Twist Drill to the desired depth with an in-and-out motion under profuse irrigation using the Guided drill Guide for guidance.

Maximum speed 800 rpm

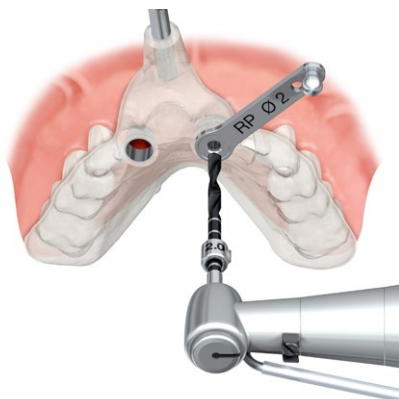
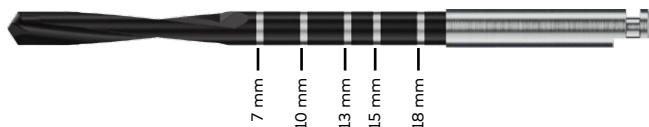

Tips

- The depth markings on the twist drill correspond to 7, 10, 13, 15 and 18 mm implants and should be measured while level with the Guided Drill Guide.
- When using the twist drill, use copious irrigation and an 'in-and-out' drilling motion with emphasis on bringing the tip of the drill out of the template when preparing the site to avoid overheating.
- A (10+) indicates that the drills extend an additional 10 mm.
- During surgery maximum attention must be paid to ensure that the surgical template does not move in any direction from the correct position when being manipulated with instruments, e.g., lateral shift through inadequate handling of pilot drill in 'knife-edge' situations or shift/deformation of surgical template due to excess vertical force application during implant installation.

3 Continue drilling

- Mount the Drill Stop Ø 2.8mm on the Guided Twist Drill Ø 2.4/2.8 x (10+) 7-18mm (optionally use the Guided Twist Drill Ø 2.4/2.8 x (10+)7-13 mm) for a safe and accurate drilling procedure.
- Place the Guided Drill Guide RP to Ø 2.8 mm in the selected template sleeve.
- Drill with an in-and-out motion under profuse irrigation.

Maximum speed 800 rpm

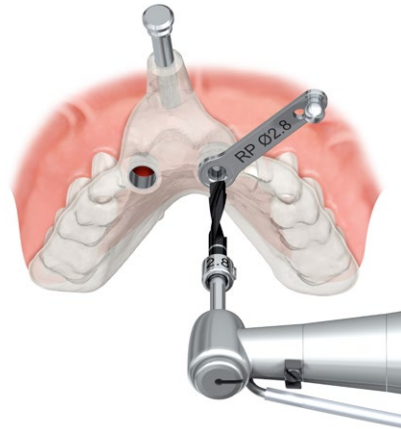

4 Use Guided Counterbore (Cortical Drill) for medium to dense bone

- Use the Guided Counterbore (Cortical Drill) NobelParallel CC 4.3.
- Drill to the built-in drill stop with an in-and-out motion under profuse irrigation.

The Guided Counterbore (Cortical Drill) NobelParallel CC is used prior to the Guided Screw Tap (if screw tap is used). This:

- Reduces compression around the neck of the implant.
- Prevents collision of the Guided Screw Tap and the Guided Implant Mount with the crest of the bone.
- Ensures full guidance is achieved.

Maximum speed 800 rpm

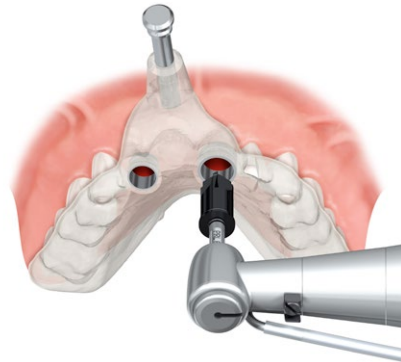

5 Use Guided Screw Tap (dense bone, option for medium bone)

- Select the Guided Screw Tap CC 4.3 11.5-13mm.
- Place the Guided Screw Tap directly into the guided sleeve of the surgical template and prepare the site using low speed (25 rpm) with copious irrigation.
- Switch the handpiece to reverse mode and back the screw tap out.

Low speed 25 rpm



The use of the Guided Screw Tap NobelParallel CC is indicated in medium bone situations and mandatory in hard bone situations. This is to help ensure proper seating of the implant. When using the screw tap, refer to the depth marks that correspond with the relevant implant length.

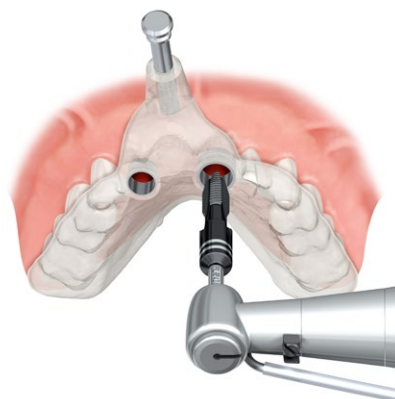

Tips

- When the depth marking of the screw tap is aligned with the implant length, the apical portion of the osteotomy is not pre-tapped, allowing direct engagement with the tip of the implant.
- If the implant does not seat after using the screw tap, widen the site with the next drill on the drilling protocol, then use the screw tap again.

6 Open implant package

- Open the outer packaging of the implant.
- Peel off the sealed blister lid in order to open it and allow the plastic vial on the sterile field.
- Unscrew the lid and take out the sterile titanium vial, lift off the color-coded titanium vial cap to gain access to the implant.



7 Pick up mounted implant

- Connect the Guided Implant Mount NobelParallel CC RP 4.3 to the implant using a Unigrip Screwdriver and the surgical adapter from the Manual Torque Wrench.
- Make sure that the Guided Implant Mount is fully seated on the shoulder of the implant platform.
- Pick up the implant with the handpiece using the Connection to Handpiece.

Tip Guided Implant Mounts are screw-retained to ensure correct depth stop and prevent implant disconnection from Guided Implant Mount when over-torquing. However, over-torquing must be avoided at all times.



Guided implant placement – partially edentulous

8 Insert the mounted implant

- Insert the implant until the flange of the Guided Implant Mount touches the outer surface of the guided sleeve in the surgical template. The Guided Implant Mount includes a vertical stop. Ensure that the Guided Implant Mount is kept in the center of the guided sleeve during the entire insertion process.
- Avoid further tightening of the implant as it might affect the correct position of the surgical template.
- Use a Unigrip Screwdriver to remove the Guided Implant Mount(s).

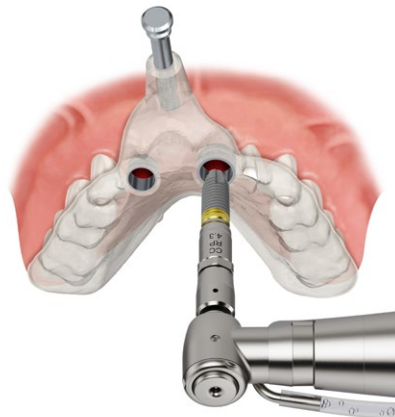

Low speed 25 rpm Max. torque 45 Ncm

Note If the Guided Implant Mount is difficult to remove, gently wiggle it free using an open-end wrench or forceps.

9 Anchor the surgical template

- Use the Guided Template Abutment NobelParallel CC RP.
- Tighten manually using a Unigrip Screwdriver.
- Ensure that the surgical template maintains its initial correct position for the next implant site preparation.

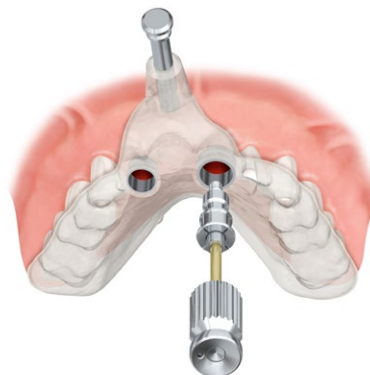

10 Place remaining implants

- Proceed with preparation of the remaining implant sites.
- Install the remaining implants according to the previously described procedure.

Tips

- Place Guided Template Abutments on the first two implants. After placement, leave the Guided Implant Mounts seated in their final position until all implants are placed.
- If only two implants are to be placed, there is no need for a Guided Template Abutment on the second implant.

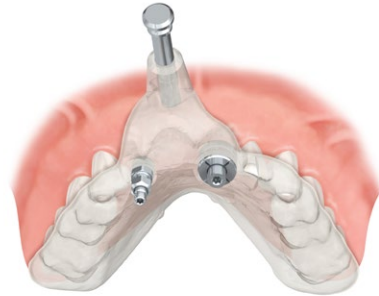

11 Remove surgical template

- Once all implants are installed, remove the Guided Implant Mounts and Guided Template Abutments using the Unigrip Screwdriver.
- Remove the anchor pins and the surgical template.

Note If the Guided Implant Mount is difficult to remove, gently wiggle it free using an open-end wrench or forceps.



Guided implant placement – edentulous

8 Insert the first mounted implant

- Insert the first implant (for example in the canine position) until the flange of the Guided Implant Mount is 1 mm short of the outer surface of the surgical template sleeve.
- Leave the Guided Implant Mount in place.

Low speed 25 rpm / Max. torque 45 Ncm

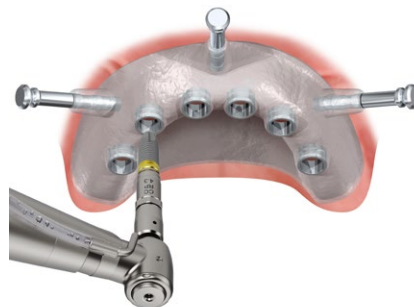

9 Insert the second mounted implant

- Choose the implant site strategically placed in the middle of the opposite half of the arch to obtain proper distribution.
- Prepare and insert the second implant until the flange of the Guided Implant Mount is 1 mm short of the outer surface of the surgical template sleeve.

Low speed 25 rpm / Max. torque 45 Ncm

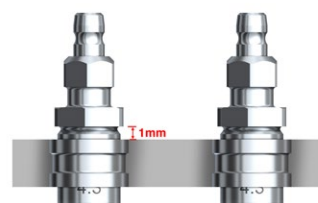
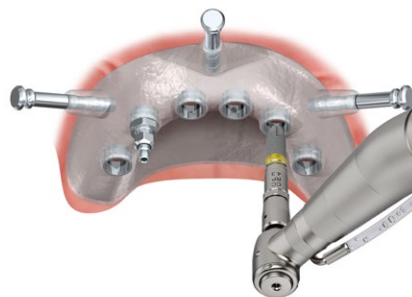

10 Finalize implant insertion

- Remove the Connection to Handpiece.
- Using the Manual Torque Wrench Surgical, carefully seat the first and second implant until the flange of the Guided Implant Mounts slightly touch the surgical template sleeve.

Max. torque 45 Ncm

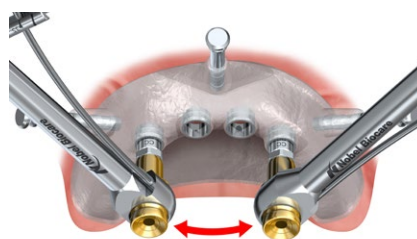

Tip Follow the described protocol to minimize the risk of over-torquing and to minimize movement of the surgical template.

11 Anchor the surgical template

- Use the Unigrip Screwdriver to remove the Guided Implant Mounts.
- Place a Guided Template Abutment NobelParallel CC RP 4.3 onto each of the seated implants.
- Tighten manually using the Unigrip Screwdriver.
- Ensure that the surgical template maintains its initial correct position for the following implant site preparation.

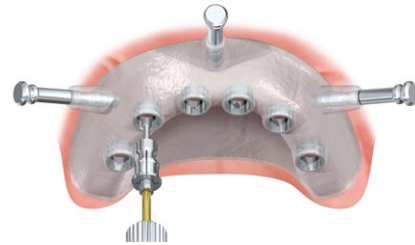

Note If the Guided Implant Mount is difficult to remove, gently wiggle it free using an open-end wrench or forceps.

12 Install remaining implants

- Proceed with preparation of the remaining implant sites.
- Install the remaining implants until the flange of the Guided Implant Mount touches the top of the guided sleeve in the surgical template.

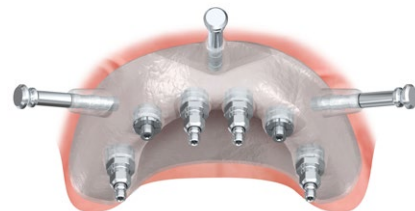

Tip Place the Guided Template Abutments on the first two implants. After placement, leave the seated Guided Implant Mounts in their final position until all implants are placed.

13 Remove surgical template

- Once all implants are installed, remove the Guided Implant Mounts and Guided Template Abutments using the Unigrip Screwdriver.
- Remove the anchor pins and the surgical template.



Note If the Guided Implant Mount is difficult to remove, gently wiggle it free using an open-end wrench or forceps.

Guided drilling and implant placement NobelReplace® CC TiUltra™



Technical specifications

The NobelReplace CC TiUltra system is designed for ease of use in all bone densities.

The Guided Twist Drill Tapered Ø 2 (10+) 8–16 mm and all tapered drills and screw taps are designed for internal irrigation, except the Guided Start Drill and Guided Counterbore NobelReplace (internal opening through the top of the drill towards the tip to be connected with compatible contra-angles).

The Guided Counterbore NobelReplace (single use) is to be used at the end of the drilling procedure (max 800 rpm) to allow adequate access for the Guided Implant Mount.

Cautions

- Guided Tapered Drills extend up to 1 mm longer than the implant when seated. Allow for this additional length when drilling near anatomical structures (the yellow safety zone in the DTX Studio Implant Software includes the extended drill lengths).
- Never exceed insertion torque of 45 Ncm. Overtightening an implant may lead to damage of the implant, fracture or necrosis of the bone site.
- Guided Implant Mount Conical Connection is developed for NobelReplace Tapered Conical Connection implants only and must not be used for NobelActive implants.
- The Guided Twist Drill Tapered Ø 2 mm is identified by the (10+) designation on the shaft. This indicates the drill is 10 mm longer to compensate for the height of the surgical template and Guided Drill Guide. The level should be measured with the Guided Drill Guide 2 mm in place.
- For reasons of drilling precision the step using the Guided Tapered Drill NP 8 mm is mandatory and must not be omitted.
- The Guided Tapered Drills are identified by the (+) designation on the shaft. The inbuilt depth stops on the Guided Tapered Drills correspond to the 8, 10, 11.5, 13, and 16 mm implants. This indicates the tapered drills are 9 mm longer than the non-guided instruments to compensate for the height of the surgical template's inbuilt guided sleeve. Drills extend up to 1 mm longer than the implant when seated.

Drill sequence illustration

Introduction to concept of this drill sequence

The drilling protocol for guided surgery follows the original freehand sequence. In addition to this protocol is the Guided Start Drill (round bur), which is intended to be used to its full depth in conjunction with the Guided Drill Guide to $\text{\O} 2$ mm and is used prior to the Guided Twist Drill Tapered $\text{\O} 2$ (10+) 8–16 mm. The 2 mm twist drill is drilled to the intended depth as defined by the treatment plan. Following the 2 mm twist drill, the Guided Drill Tapered NP 3.5 \times (+) 8 mm

needs to be used. This drill is guided before engaging the bone and provides guidance for the longer NP drill (if an implant longer than 8 mm NP is placed).

Caution For reasons of drilling precision, the step using the 8 mm drill is mandatory and must not be skipped.

In dense bone situations, if indicated, both the Dense Bone Drill and the Guided Screw Tap are to be used if insertion torque exceeds 45 Ncm.

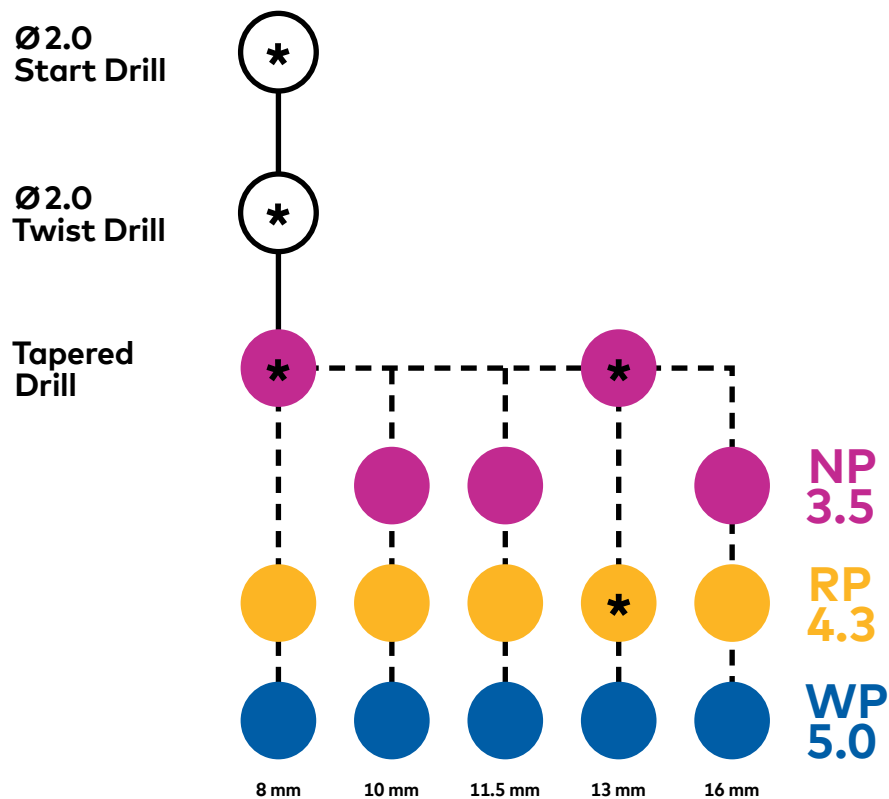

* The drill protocol of a 4.3x13 mm implant is illustrated on [page 112](#).

R

Drill sequence

Demonstration of the guided drill protocol for a $\varnothing 4.3 \times 13$ mm implant in soft, medium and dense bone.

Soft & medium bone



Dense bone

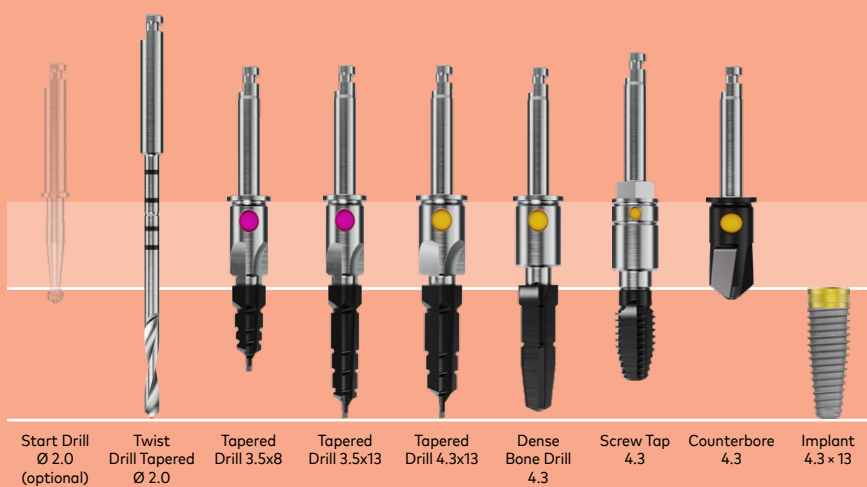

Drill protocols according to bone quality

During drilling procedures bone quality should be considered. Recommended drill sequences are based on bone quality.

Drilling must proceed at high speed (max. 800 rpm for twist drills and tapered drills) under constant and profuse irrigation by sterile saline at room temperature.

Optional drills

If bone density is inconsistent (varying between medium and soft or medium and dense bone), optional drills can be added to the drill protocol. These optional drills and screw taps are denoted in the table in parentheses.

Platform	Implant lengths	Soft & medium bone Type II-IV	Dense bone Type I
NP 3.5	8 mm 10 mm 11.5 mm	2.0 3.5 x 8 (3.5 x 10) (3.5 x 11.5) Counterbore 3.5	2.0 3.5 x 8 (3.5 x 10) (3.5 x 11.5) Screw Tap 3.5 Counterbore 3.5
	13 mm 16 mm	2.0 3.5 x 8 3.5 x 13 (3.5 x 16) Counterbore 3.5	2.0 3.5 x 8 3.5 x 13 (3.5 x 16) Dense Bone Drill 3.5 Screw Tap 3.5 Counterbore 3.5
RP 4.3	8 mm 10 mm 11.5 mm	2.0 3.5 x 8 (3.5 x 10) (3.5 x 11.5) 4.3 x 8/10/11.5 Counterbore 4.3	2.0 3.5 x 8 (3.5 x 10) (3.5 x 11.5) 4.3 x 8/10/11.5 Screw Tap 4.3 Counterbore 4.3
	13 mm 16 mm	2.0 3.5 x 8 3.5 x 13 (3.5 x 16) 4.3 x 13/16 Counterbore 4.3	2.0 3.5 x 8 3.5 x 13 (3.5 x 16) 4.3 x 13/16 Dense Bone Drill 4.3 Screw Tap 4.3 Counterbore 4.3
WP 5.0	8 mm 10 mm 11.5 mm	2.0 3.5 x 8 (3.5 x 10) (3.5 x 11.5) 4.3 x 8/10/11.5 5.0 x 8/10/11.5 Counterbore 5.0	2.0 3.5 x 8 (3.5 x 10) (3.5 x 11.5) 4.3 x 8/10/11.5 5.0 x 8/10/11.5 Screw Tap 5.0 Counterbore 5.0
	13 mm 16 mm	2.0 3.5 x 8 3.5 x 13 (3.5 x 16) 4.3 x 13/16 5.0 x 13/16 Counterbore 5.0	2.0 3.5 x 8 3.5 x 13 (3.5 x 16) 4.3 x 13/16 5.0 x 13/16 Dense Bone Drill 5.0 Screw Tap 5.0 Counterbore 5.0

Tip All data are in mm, drills within brackets (-) need to be chosen depending on implant lengths.

Tip The Guided Dense Bone Drill Tapered is only needed for 13 mm and 16 mm implants. With shorter implants, the dense bone protocol is to use the Screw Tap matching the diameter of the implant.

Caution For reasons of drilling precision the step using the Guided Tapered Drill NP 8 mm is mandatory and must not be omitted.

Drilling sequence

The following procedure and illustrations show the use of NobelReplace CC RP 4.3 × 13 mm (for drilling protocols in all bone situations, see [page 111](#)). For further information, please refer to Instructions For Use NobelReplace CC and NobelGuide.

1 Drill with Pilot Twist Drill

- Start drilling one implant first, from start to finish, including guided implant insertion.
- Place the Guided Drill Guide RP to Ø 2 mm in the first RP template sleeve.
- Drill with the Guided Start Drill to the built-in drill stop.

Maximum speed 800 rpm

2 Drill with Guided Twist Drill

- Mount a Drill Stop Ø 2mm on the Guided Twist Drill Tapered Ø 2 × (10+) 8-16mm
- Place the Guided Drill Guide RP to Ø 2 mm in the selected template sleeve.
- Drill with the Guided Twist Drill Tapered Ø 2 × (10+) 8-16 mm to the desired depth with an in-and-out motion under profuse irrigation using the Guided Drill Guide for guidance.

Maximum speed 800 rpm

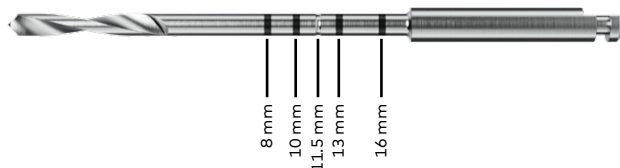

Tips

- The depth markings on the Guided Twist Drill Tapered correspond to 8, 10, 11.5, 13 and 16 mm implants and should be measured while level with the Guided Drill Guide.
- When using the Guided Twist Drill, use copious irrigation and an "in-an-out" drilling motion with emphasis on bringing the tip of the drill out of the template when preparing the site to avoid overheating.
- A (10+) indicates that the drills extend an additional 10 mm.
- During surgery maximum attention must be paid to ensure that the surgical template does not move in any direction from the correct position when being manipulated with instruments, e.g. lateral shift through inadequate handling of drills in "knife-edge" situations or shift/deformation of surgical template due to excess vertical application during implant installation.

3 Drill with Guided Drill Tapered NP 8 mm

- Use Guided Drill Guide RP to NP.
- Drill with Guided Drill Tapered NP 3.5 × (+) 8 mm to the in-built drill stop with an in-and-out motion under profuse irrigation.

Maximum speed 800 rpm



Tip To ensure the guiding principle of the first tapered drill, the NobelReplace Tapered guided drilling protocol demands use of the 8 mm NP drill for all implant lengths and diameters. The 8 mm NP drill is guided through the sleeve before engaging the bone.

4 Continue drilling

- For 13 mm length, move directly to the Guided Drill Tapered NP 3.5 × (+) 13 mm.
- Use the same Guided Drill Guide RP to NP and repeat the procedure, drilling with and in-and-out motion under profuse irrigation.

Maximum speed 800 rpm

Tip When a 16mm implant is planned, drill first with the Guided Drill Tapered NP 3.5 × (+) 8mm followed by the Guided Drill Tapered NP 3.5 × (+) 13 mm and then with the Guided Drill Tapered NP 3.5 × (+) 16 mm to ensure fully guided osteotomy preparation.

Maximum speed 800 rpm

5 Continue drilling

- Use the Guided Drill Tapered RP 4.3 x (+) 13 mm directly through the guided sleeve in the surgical template.
- Enlarge the implant site, drilling with an in-and-out motion under profuse irrigation.

Maximum speed 800 rpm

Option: Dense bone situation

- Use the Guided Dense Bone Drill Tapered RP and/or Guided Screw Tap Tapered RP in situations with dense jawbone or locally dense bone.
- Guided Dense Bone Drill Tapered is only needed for 13 mm and 16 mm implants.
- Select the Guided Dense Bone Drill matching the diameter and length (13 or 16 mm) for final tapered implant.

Maximum speed 800 rpm

Option: Guided Screw Tap Tapered

- For 8 mm implants, use Guided Screw Tap Tapered and proceed to first depth marking.
- For 10, 11.5, 13 and 16 mm implants, tap to second depth marking.

Low speed Max. torque 45 Ncm

Option: Guided Counterbore (Cortical drill)

Use the Guided Counterbore NobelReplace as a countersink at the end of the drilling procedure to create adequate access for the Guided Implant Mount during implant installation.

6 Open implant package

- Open the outer packaging of the implant.
- Peel off the sealed blister lid in order to open it and allow the plastic vial on the sterile field.
- Unscrew the lid and take out the sterile titanium vial, lift off the color-coded titanium vial cap to gain access to the implant.



7 Pick up mounted implant

- Connect the Guided Implant Mount NobelReplace CC to the implant using a Unigrip Screwdriver and the surgical adapter from the Manual Torque Wrench.
- Make sure that the Guided Implant Mount is fully seated on the shoulder of the implant platform.
- Pick up the implant with the handpiece using the Connection to Handpiece.

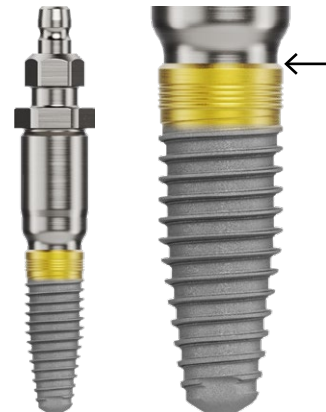

Tip Guided Implant Mounts are screw-retained to ensure correct depth stop and prevent implant disconnection from Guided Implant Mount when over-torquing. However, over-torquing must be avoided at all times.

Caution Guided Implant Mount Conical Connection is developed for NobelReplace Tapered Conical Connection implants only and must not be used for NobelActive implants.

Guided implant placement – partially edentulous

8 Insert the mounted implant

- Insert the implant until the flange of the Guided Implant Mount touches the outer surface of the guided sleeve in the surgical template. The Guided Implant Mount includes a vertical stop. Ensure that the Guided Implant Mount is kept in the center of the guided sleeve during the entire insertion process.
- Avoid further tightening of the implant as it might affect the correct position of the surgical template.
- Use a Unigrip Screwdriver to remove the Guided Implant Mount(s).

Low speed 25 rpm / Max. torque 45 Ncm

Note If the Guided Implant Mount is difficult to remove, gently wiggle it free using an open-end wrench or forceps.

9 Anchor the surgical template

- Use the Guided Template Abutment NobelReplace CC RP 4.3.
- Tighten manually using a Unigrip Screwdriver.
- Ensure that the surgical template maintains its initial correct position for the next implant site preparation.

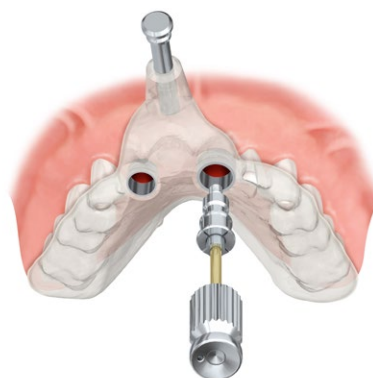

10 Place remaining implants

- Proceed with preparation of the remaining implant sites.
- Install the remaining implants according to the previously described procedure.

Tips

- Place Guided Template Abutments on the first two implants. After placement, leave the Guided Implant Mounts seated in their final position until all implants are placed.
- If only two implants are to be placed, there is no need for a Guided Template Abutment on the second implant.

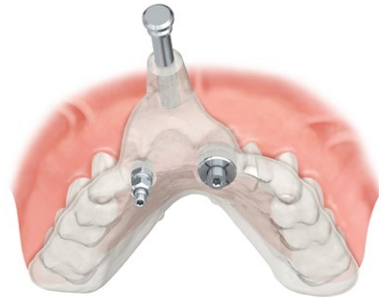

11 Remove surgical template

- Once all implants are installed, remove the Guided Implant Mounts and Guided Template Abutments using the Unigrip Screwdriver.
- Remove the anchor pins and the surgical template.

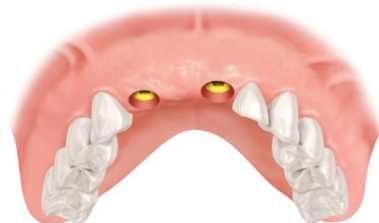

Note If the Guided Implant Mount is difficult to remove, gently wiggle it free using an open-end wrench or forceps.

Guided implant placement – edentulous

8 Insert the first mounted implant

- Insert the first implant (for example in the canine position) until the flange of the Guided Implant Mount is 1 mm short of the outer surface of the surgical template sleeve.
- Leave the Guided Implant Mount in place.

Low speed 25 rpm / Max. torque 45 Ncm

9 Insert the second mounted implant

- Choose the implant site strategically placed in the middle of the opposite half of the arch to obtain proper distribution.
- Prepare and insert the second implant until the flange of the Guided Implant Mount is 1 mm short of the outer surface of the surgical template sleeve.

Low speed 25 rpm / Max. torque 45 Ncm

10 Finalize implant insertion

- Remove the Connection to Handpiece.
- Using the Manual Torque Wrench Surgical, carefully seat the first and second implant until the flange of the Guided Implant Mounts slightly touch the surgical template sleeve.

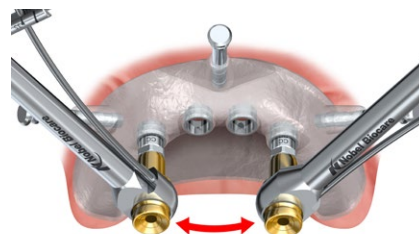

Tip Follow the described protocol to minimize the risk of over-torquing and to minimize movement of the surgical template.

Max. torque 45 Ncm

11 Anchor the surgical template

- Use the Unigrip Screwdriver to remove the Guided Implant Mounts.
- Place a Guided Template Abutment NobelReplace CC RP 4.3 onto each of the seated implants.
- Tighten manually using the Unigrip Screwdriver.
- Ensure that the surgical template maintains its initial correct position for the following implant site preparation.

Note If the Guided Implant Mount is difficult to remove, gently wiggle it free using an open-end wrench or forceps.

12 Install remaining implants

- Proceed with preparation of the remaining implant sites.
- Install the remaining implants until the flange of the Guided Implant Mount touches the top of the guided sleeve in the surgical template.

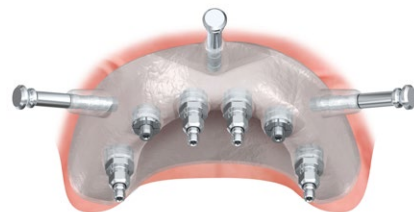

Tip Place the Guided Template Abutments on the first two implants. After placement, leave the seated Guided Implant Mounts in their final position until all implants are placed.

13 Remove surgical template

- Once all implants are installed, remove the Guided Implant Mounts and Guided Template Abutments using the Unigrip Screwdriver.
- Remove the anchor pins and the surgical template.



Note If the Guided Implant Mount is difficult to remove, gently wiggle it free using an open-end wrench or forceps.

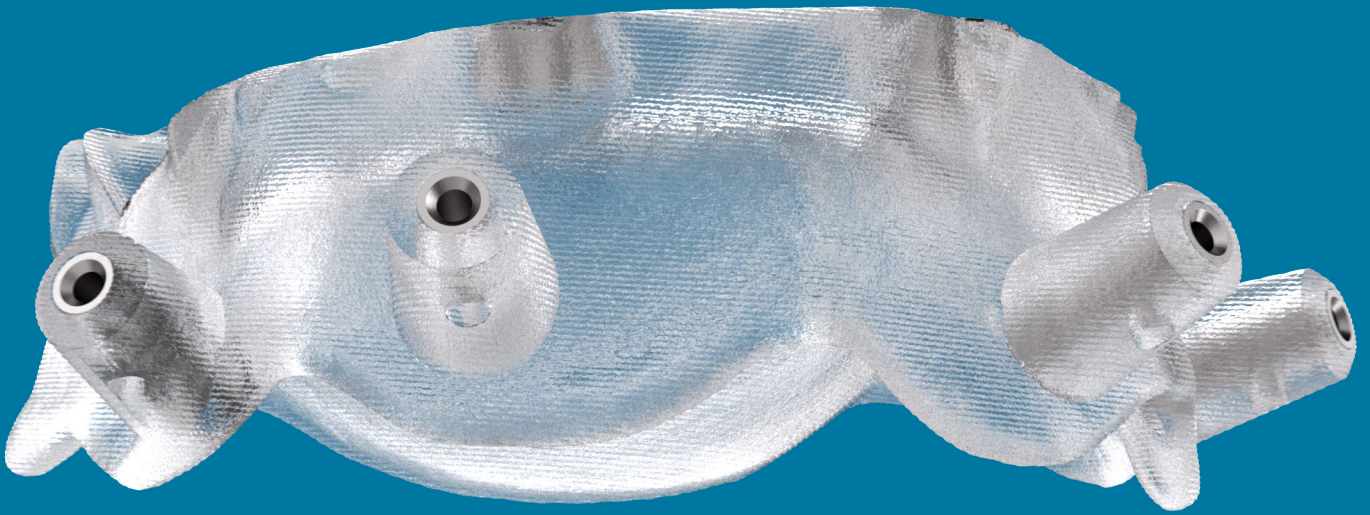

Prosthetic procedure

Temporization 124

Temporization

With TempShell

The TempShell is a screw-retained CAD/CAM provisional that can be used at the day of surgery. Immediate provisionals enable a patient to obtain a temporary crown or bridge at their implant placement appointment. To achieve this, the DTX Studio Implant

user and the dental laboratory (using DTX Studio Lab) work together to design a TempShell which can be converted into a provisional by the clinician at the time of surgery.

1 Planning a TempShell in DTX Studio Implant

Plan the TempShell using DTX Studio Implant. For detailed information please refer to the Instructions For Use for DTX Studio Implant.

2 Designing a TempShell in DTX Studio Lab

The TempShell order is sent from DTX Studio Implant to DTX Studio Lab. The dental laboratory designs a LabDesign that is shared back with the DTX Studio Implant user. For detailed information please refer to the Instructions For Use for DTX Studio Lab and DTX Studio Implant.

3 Creating a TempShell

The final design can be exported as an .stl file which can be printed or milled.

4 Connect abutment to implant

- Connect the Temporary Snap Abutment (no screw needed).
- Protect the screw access hole with a suitable material.



5 Convert TempShell into individualized provisional restoration

- a) Partially fill TempShell with composite material
- b) Use the wings to place the TempShell in the correct position
- c) Light cure to harden the composite material
- d) Remove TempShell with snap abutment and fill shell completely
- e) Light cure to harden the composite material
- f) Remove the wings
- g) Specially designed tooling simplifies creation of the occlusal screw channel



a)



b)



c)



d)



e)



f)



g)

6 Connect temporary restoration

- Fasten the temporary restoration with the abutment screw using the Unigrip Screwdriver.
- Fill screw access holes with suitable material.



Conventional

The NobelGuide surgery concept allows complete freedom to choose the appropriate prosthetic solution to satisfy patient requirements as well as the clinical situation.

Provisional prosthetic solution

Using dedicated laboratory tooling, a surgical guise is designed to also hold implant replicas at intended positions. This allows for the fabrication of a stone model containing these replicas prior to surgery. Provisional prosthetic solutions can then be prepared and later finalized directly after surgery.

Complete range of provisional prosthetic solutions

For provisional prosthetic solutions in immediate, early or delayed function situations, a complete range of Nobel Biocare abutments can be used depending on the selected implant system and abutment connection and also depending on patient indication and preferences of the treating team.

- Temporary Abutment
- QuickTemp Abutment
- Snappy Abutment
- Esthetic Abutment
- Multi-unit Abutment
- Procera Esthetic Abutment in zirconia (Abutment Selectin Kit)
- NobelProcera Abutment in zirconia and titanium (designed and ordered in DTX Studio Lab)

The following illustrations show the use of Temporary Abutments Non-Engaging for a partial restoration in the maxilla. The abutments have been shortened by the dental laboratory prior to surgery.

1 Connect abutment to implant

- Connect the abutment using the abutment screw and the Unigrip Screwdriver.
- Block out undercuts on adjacent teeth if necessary.
- Fill the screw access hole with suitable material.



2 Make temporary restoration

- Make a temporary restoration by using a plastic mold with temporary crown and bridge material or use a prefabricated provisional restoration to pick up temporary abutments in correct locations.
- Remove restoration and mold by unscrewing abutment screws.
- Make final adjustments to restoration.

3 Connect temporary restoration

- Fasten the temporary restoration with the abutment screw using the Unigrip Screwdriver.
- Fill screw access holes with suitable material.



4 Final restoration

Follow established prosthetic procedures for the final restoration after a sufficient healing period.

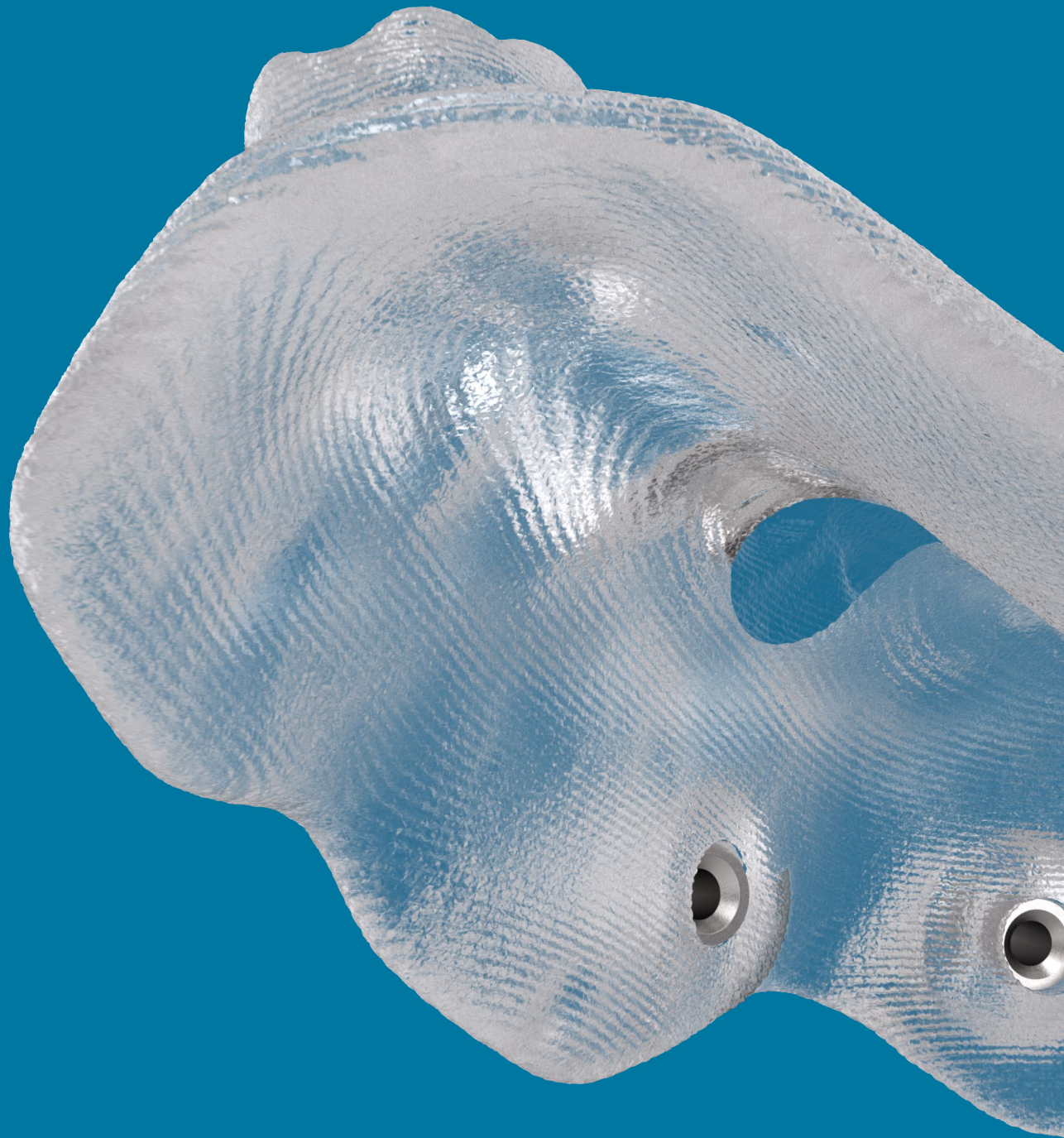

Appendices

- Manual Torque Wrench 132
- Guided Anchor Pins 134
- Calibration procedure for radiographic guide 136
- CT Protocols 137
- Cleaning and sterilization 138

Manual Torque Wrench

For the surgeon, the torque required to place implants provides insight into the primary stability of the implant. For restorative procedures, tightening the abutment and prosthetic screws to the recommended torque specifications will more effectively control screw-joint integrity during patient function.

The Manual Torque Wrench is a convenient tool for achieving the desired torque.

Manual Torque Wrench – Surgical

Intended for tightening or adjusting implant position.

- Indicating torque values 45 Ncm and 70 Ncm.
- Insert Implant Driver Conical Connection.

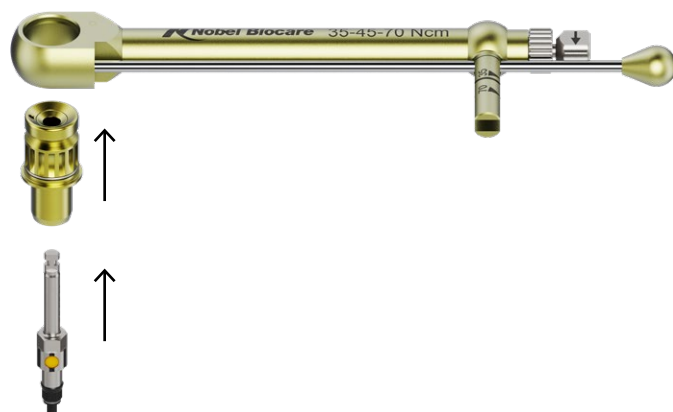

Manual Torque Wrench – Prosthetic

Intended for tightening or adjusting implant position.

- Indicating torque values 15 Ncm and 35 Ncm.
- Compatible with all machine screwdrivers.
- Insert the applicable driver.



Use of the Manual Torque Wrench Surgical

- Select the corresponding Manual Torque Wrench Adapter Surgical and insert the corresponding Implant Driver into the adapter.
- To tighten an implant, adjust the direction indicator so that the arrow is pointing toward the level arm and rotate clockwise.
- To loosen an implant, adjust the direction indicator so that the arrow is pointing away from the level arm, and rotate counterclockwise.

Warning If force is applied to the main body of the Manual Torque Wrench Surgical and not to the lever arm, the applied torque cannot be measured. High forces may cause over compression of the bone leading to bone resorption, especially in case of a thin buccal/lingual marginal bone crest.

After use, disassemble the Manual Torque Wrench by removing the adapter and the rod from the wrench body. Please follow the steps described in the IFU for Manual Torque Wrenches Surgical and Prosthetic.

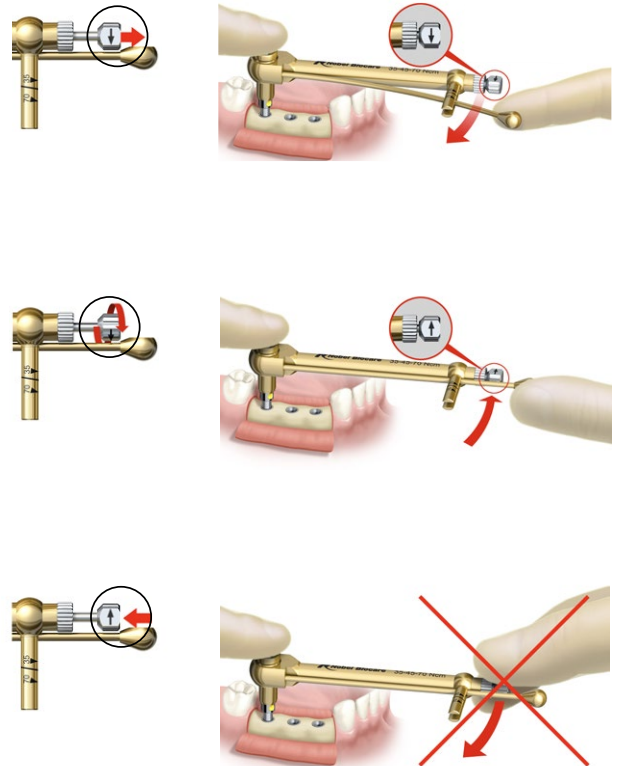

Guided Anchor Pins

To establish secure fixation and stability of the surgical template at the start and during the surgical procedure, Guided Anchor Pins are used to anchor the surgical template. They can also serve as 'lip retractor' and, in certain situations, as potential flap retractor.

When planning anchor pin positions, inclination and depth are important. Typically 4–5 anchor pins are placed in an edentulous jaw. In order to gain stable support and also to allow for temporary removal and exact repositioning of the surgical template during specific surgical procedures (mini-flap and flap protocols), the anchor pins must be placed in areas with adequate cortical bone. To minimize the risk of injuries due to penetration, bi-cortical anchorage of anchor pins must be avoided.

Take the mouth opening into consideration. Placing anchor pins too distally may prevent the patient from opening their mouth wide enough to accommodate the drills and handpiece.

Tips

- Short shaft anchor pins are also available and can be used to reduce this negative impact.
- To define the inclination, the relationship of the anchor pin and the surrounding soft tissues (position of the lips and the maximum opening of the mouth) should be taken into consideration. The inclination should allow for easy access and installation of the anchor pins.
- To control the insertion depth of the anchor pins, check that the anchor pin sleeve fits correctly in the radiographic guide. The most apical aspect of the sleeve should be positioned within the flange and away from the transition of the radiographic guide and gingiva to allow for the production of the surgical template.

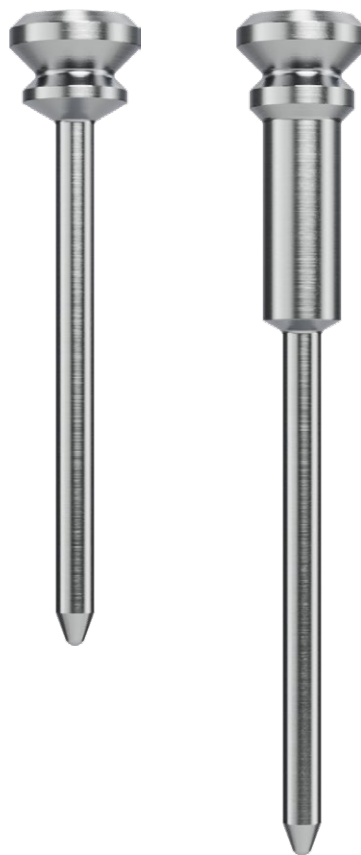

Technical considerations

Correct:

- Optimal anchor pin position
(Anchor pin sleeve is within the radiographic guide flange and the anchor pin is embedded in sufficient bone.)

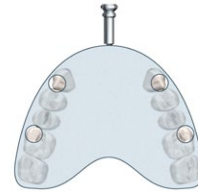

Incorrect:

- Anchor pin is not placed deep enough
(Anchor pin sleeve is not within the radiographic guide flange.)
- Anchor pin is placed too deep
(Anchor pin sleeve is protruding into the fitting surface of the radiographic guide. This will prevent correct seating of the surgical template.)

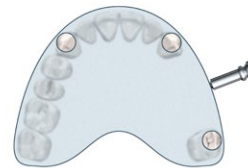

Retention principles:

- An adequate number of anchor pins must be placed with strategic positioning and orientation to secure the surgical template in the correct position.
- For edentulous jaws consider placing four or more anchor pins. Ensure mouth opening through lip retraction is not compromised.
- For single tooth situations do not use anchor pins to avoid any damage to surrounding structures. Retention is obtained by pressing the surgical template onto existing teeth. Verify continuously that the surgical template is correctly seated via the inspection windows.

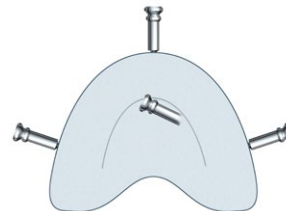
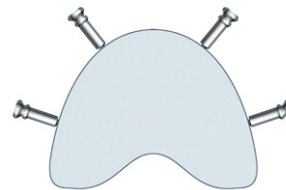
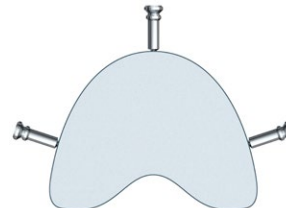
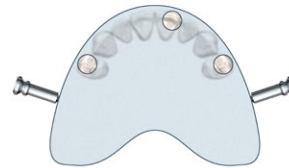

Tip In situations where two or more neighboring implants are placed, regardless if it is a free-end situation or a situation with one or more distal teeth for support of the surgical template, it is recommended to use at least one anchor pin in this area.

Advanced usage

- Recommended with (mini-)flaps
- Consider mouth opening when planning in distal locations since lip retraction affects mouth opening

Calibration procedure for radiographic guide

Accuracy is crucial

Accurate fit of the surgical template is crucial for predictable surgical results. These dimensions are defined through the radiographic guide which is digitized using (CB)CT technology. The crucial information for the surgical template comes from the second CT scan, which is the radiographic guide scan in the NobelGuide double-scan procedure.

Every scanner is different

The grey value (isovalue) representing the physical border of the radiographic guide is identified in the 3D volume of the scan. Based on this value, a 3D surface model is generated in DTX Studio Implant.

Correct extraction (also termed "segmentation") of this surface data from the 3D DICOM files is required to produce an accurate-fitting surgical template. As each (CB)CT scanner has an almost unique way to assign grey values (isovalues) to defined tissue, a thorough scanner-based interpretation is needed to identify the correct grey value (isovalue).

Unique NobelGuide calibration procedure

The unique NobelGuide calibration object consists of polymethyl-methacrylate (PMMA), which is a material typically used for the fabrication of radiographic guides. This high-precision object allows the DTX Studio Implant software to identify the correct grey value (isovalue) for the radiographic guide scan for each scanner by analyzing the reference scan made with the calibration object.

DTX Studio Implant software automatically manages these calibration scans and recommends when to apply the information learned. It is important that the reference scan is acquired in the very same way and with the very same scanner settings used for the radiographic guide scan.

The NobelGuide calibration procedure is easy and makes guided surgery even safer. If the analysis of the calibration scan fails with a specific scanner, please contact your Nobel Biocare expert for assistance in identifying and addressing the root cause of the failure in your specific setup.

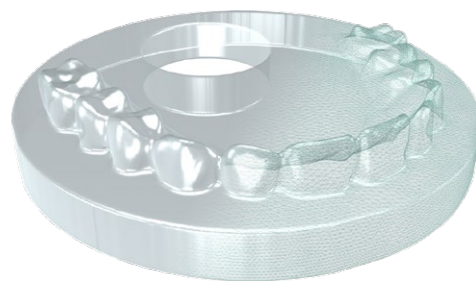

CT Protocols

Nobel Biocare has developed CT protocols with all major (CB)CT scanner manufacturers. For further information please contact the local Nobel Biocare sales office.

	Multi-slice	Single-slice	Cone-beam
Scan settings	Spiral CT / no gantry tilt	Spiral CT / no gantry tilt	<p>Follow the manufacturer's instruction to scan the patient. The size of a cubic voxel should be within the range of 0.25–0.5 mm. During reconstruction, no tilting of the axial slices is allowed.</p> <p>Note Extra care is needed in order not to overshoot the detector. Therefore, use a lower kV and mA for the radiographic guide scan, and also for the NobelGuide calibration scan.</p>
Tube voltage	120 kV	120 kV	
Effective tube current	90 mAs	100 mAs	
Collimation	Smallest detect width (mm)	1 mm	
Feed per rotation	Collimation x 0.7	1 mm/rotation	
Gantry rotation speed	n/a	1 rotations/s	
Reconstruction settings			
Interval	Half detector width (typically 0.5 mm or smaller)	0.5 mm	
Kernel	A sharp bone filter is preferred	A sharp bone filter is preferred	

Tip When scanning the NobelGuide calibration object, the exact same scan settings and reconstruction settings should be used as for the radiographic guide scan.

Cleaning and sterilization

Sterile components

Refer to the Instructions For Use (IFU2011) for Guided Surgery Tooling for detailed cleaning and sterilization instructions.

ifu.nobelbiocare.com

Note Implants must never be resterilized or reused.

Implants

Implants are delivered sterile, are for single use only, and must be used prior to the labeled expiration date.

Warning Do not use device if the packaging has been damaged or previously opened.

Caution NobelActive TiUltra implants are single use products and must not be reprocessed. Reprocessing could cause loss of mechanical, chemical and / or biological characteristics. Re-use could cause cross contamination.

Caution NobelParallel CC TiUltra implants are single use products and must not be reprocessed. Reprocessing could cause loss of mechanical, chemical and / or biological characteristics. Re-use could cause cross contamination.

Caution NobelReplace CC TiUltra implants are single use products and must not be reprocessed. Reprocessing could cause loss of mechanical, chemical and / or biological characteristics. Re-use could cause cross contamination.

Guided Start Drills, Guided Twist/Step Drills, Guided Screw Taps and Guided Counterbores

Guided Start Drills, Guided Twist/Step Drills, Guided Screw Taps and Guided Counterbores have been sterilized using irradiation and are intended for single use only. Do not use after the labeled expiration date.



Non-sterile components

Caution Care and maintenance of instruments are crucial for a successful treatment. Sterilized instruments not only safeguard your patients and staff against infection but are also essential for the outcome of the total treatment.

Refer to the Instructions For Use (IFU1067) for PureSet for detailed cleaning and sterilization instructions.

ifu.nobelbiocare.com

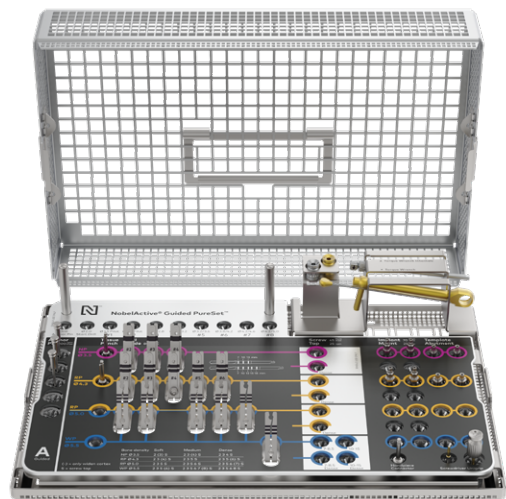

Abutments and plastic copings

Refer to the Instructions For Use (IFU1093) for the abutment or coping for detailed cleaning and sterilization instructions.

ifu.nobelbiocare.com

Notes

- If modifications have been made to the abutment, clean the abutment prior to sterilization.
- Non-sterile plastic copings should not be re-sterilized, as they are for single use only.



Order online

Order our complete range of implants and prefabricated prosthetics 24 hours a day through the Nobel Biocare online store.

nobelbiocare.com/store

Order by phone

Call our customer service team or contact your sales representative.

nobelbiocare.com/contact

Lifetime warranty

The warranty covers all Nobel Biocare implants including prefabricated prosthetic components.

nobelbiocare.com/warranty



nobelbiocare.com/nobelguide

