



# NobelParallel™

CONICAL CONNECTION

# TiUltra™

WE FOLLOW NO  
ONE.

The scope of this surgical procedures manual is to provide a comprehensive overview of the surgical steps and options during the placement of NobelParallel™ CC TiUltra™ implants. This surgical procedures manual does not replace the Instructions For Use (IFU). Please review the Instructions For Use, including Indications For Use, Contraindications, Warnings and Cautions before using the products. Instructions for Use are available at:

[ifu.nobelbiocare.com](http://ifu.nobelbiocare.com)

For a full list of article numbers and for ordering information, refer to the Product overview - Conical connection implants and prosthetics available at [nobelbiocare.com](http://nobelbiocare.com) or contact a Nobel Biocare representative.

**Note** In order to improve readability, Nobel Biocare does not use ™ or ® in the running text. By doing so, however, Nobel Biocare does not waive any right to the trademark or registered mark and nothing herein shall be construed to the contrary.

**Disclaimer** Some products may not be regulatory cleared, released or licensed for sale in all markets. Please contact the local Nobel Biocare sales office for current product assortment and availability.

# Contents

## Introduction 5

Quick guide 6

Implant specifications 8

## Surgical procedure 11

Important considerations 12

Surgical access 13

Drill sequence 14

Depth measurement system 16

Screw taps for implant placement for medium and dense bone 17

Dense bone situations 18

Flapless procedure 20

Flap procedure 21

Implant insertion 24

## Restorative procedure 29

Important considerations 30

Finalization of implant surgery and temporary restorations 34

Two-stage early/delayed function 35

One-stage early/delayed function 35

One-stage Immediate Function procedures 36

NobelParallel Conical Connection TiUltra WP posterior solution 40

## PureSet™ 43

Wallchart 44

## Appendices 49

Manual Torque Wrench 50

Cleaning and sterilization 52

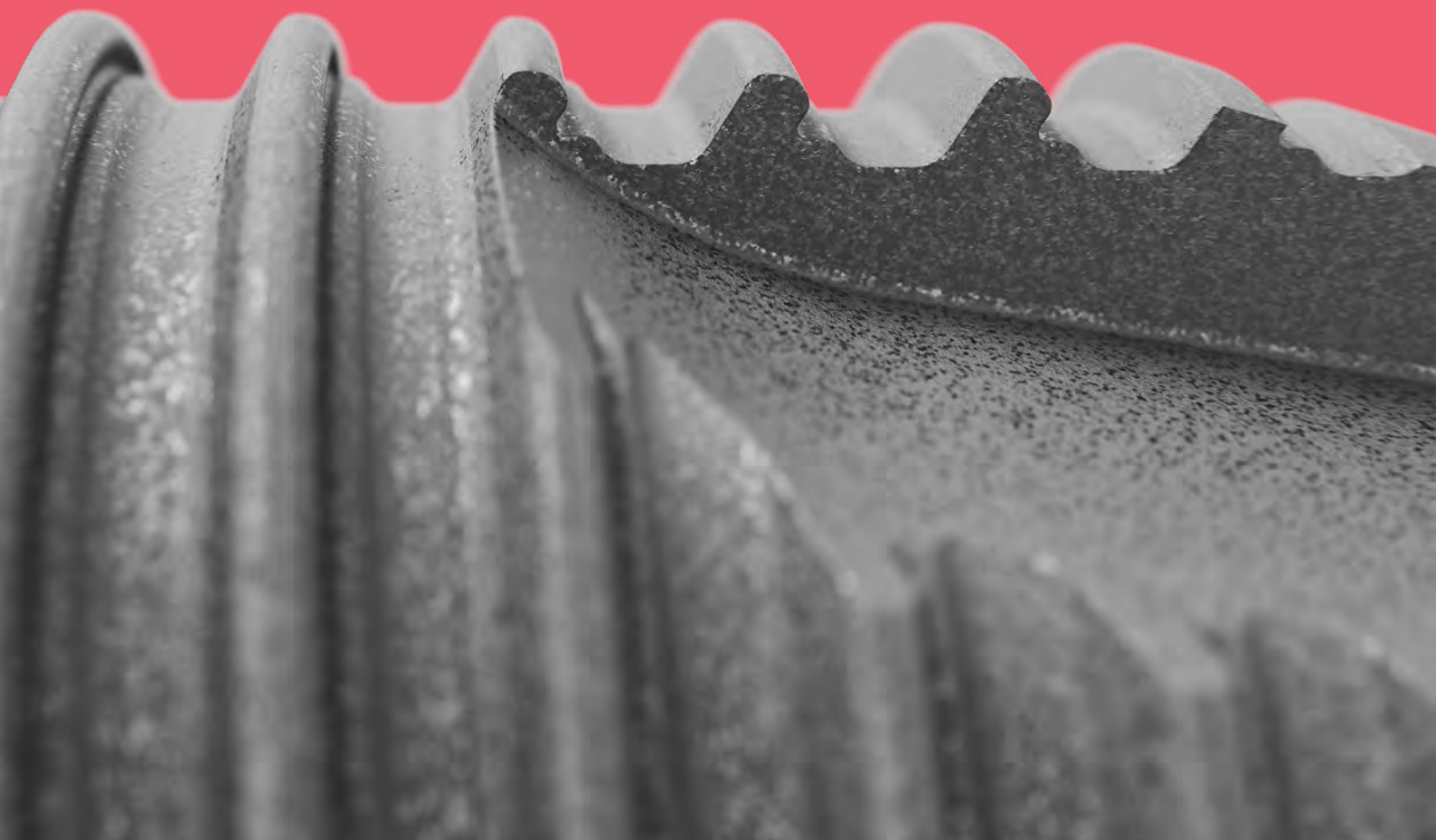



---

# Introduction

Quick guide 6

Implant specifications 8

# Quick guide

Twist Drill with  
Tip Ø 2 mm



**Flap  
technique**

Twist Step Drill  
Ø 2.4/2.8 mm



Twist Step Drill  
Ø 3.2/3.6 mm



Cortical Drill  
Ø 4.3 mm



Screw Tap  
Ø 4.3 mm optional



Twist Drill with  
Tip Ø 2 mm



**Flapless  
technique**

**Note** The illustrations show the drill sequence for NobelParallel TiUltra Conical Connection RP 4.3 in medium bone. For other implant diameters and bone densities, see drill protocols on [page 15](#).

# Implant level

One-stage  
Immediate function



One-stage early/  
delayed function



Two-stage early/  
delayed function



Implant  
placement



On1 concept/  
Multi-unit Abutment



One-stage  
Immediate function



# Abutment level

One-stage early/  
delayed function



# Implant

## SPECIFICATIONS

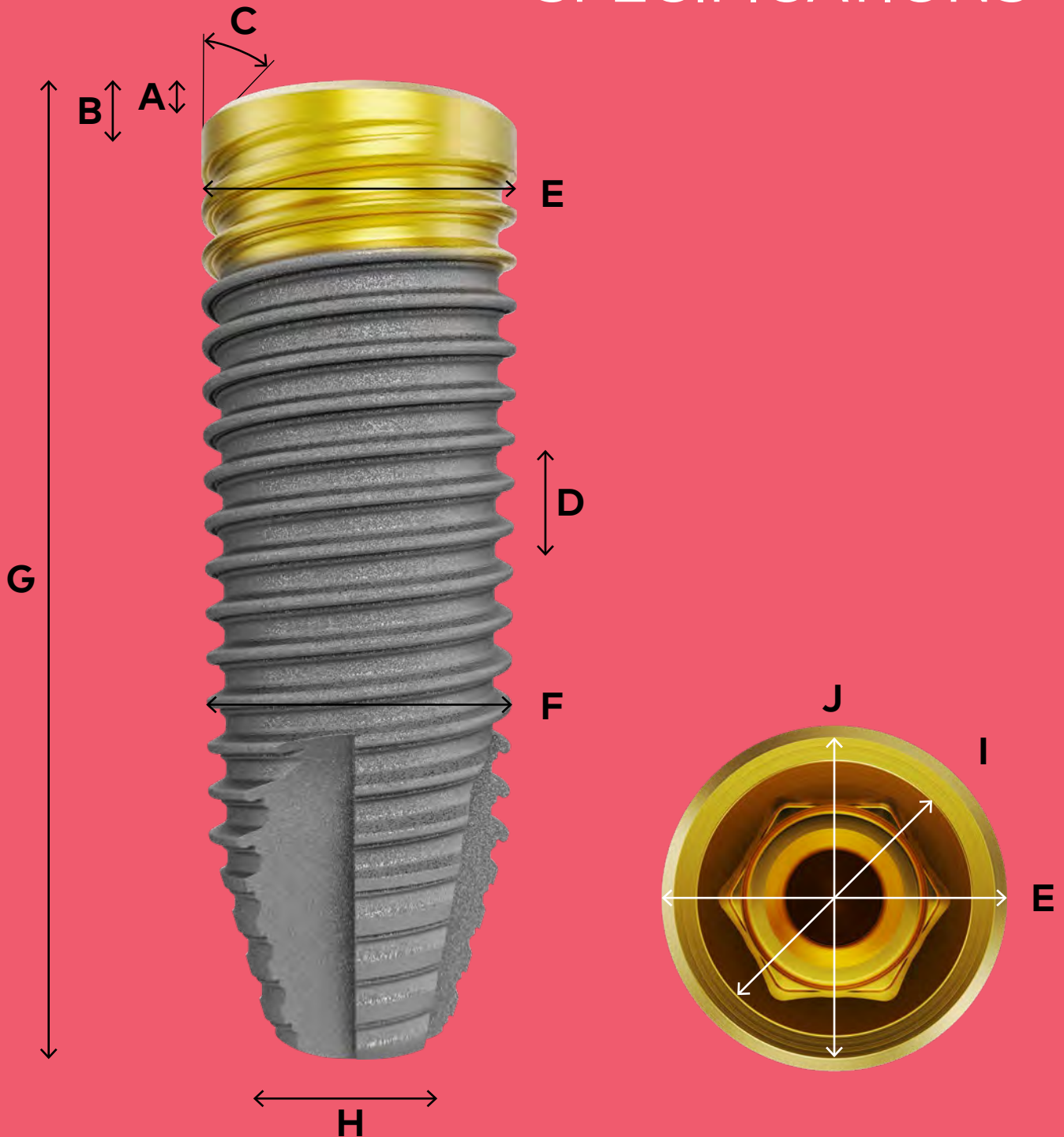



Platform		<b>A</b> Bevel height	<b>B</b> Rim height	<b>C</b> Bevel angle	<b>D</b> Thread pitch	<b>E</b> Major diameter 1	<b>F</b> Major diameter 2	<b>G*</b> Overall length	<b>H</b> Tip diameter	<b>I</b> Abutment interface	<b>J</b> Bridge interface
<b>NP 3.75</b>	3.75×7 mm	0.1	0.5	45°	1.2	3.75	3.5	6.5	2.0	3.0	3.5
	3.75×8.5 mm	0.1	0.5	45°	1.2	3.75	3.5	8.0	2.0	3.0	3.5
	3.75×10 mm	0.1	0.5	45°	1.2	3.75	3.5	9.5	2.0	3.0	3.5
	3.75×11.5 mm	0.1	0.5	45°	1.2	3.75	3.5	11.0	2.0	3.0	3.5
	3.75×13 mm	0.1	0.5	45°	1.2	3.75	3.5	12.5	2.0	3.0	3.5
	3.75×15 mm	0.1	0.5	45°	1.2	3.75	3.5	14.5	2.0	3.0	3.5
	3.75×18 mm	0.1	0.5	45°	1.2	3.75	3.5	17.5	2.0	3.0	3.5
<b>RP 4.3</b>	4.3×7 mm	0.2	0.5	45°	1.2	4.3	4.1	6.5	2.4	3.4	3.9
	4.3×8.5 mm	0.2	0.5	45°	1.2	4.3	4.1	8.0	2.4	3.4	3.9
	4.3×10 mm	0.2	0.5	45°	1.2	4.3	4.1	9.5	2.4	3.4	3.9
	4.3×11.5 mm	0.2	0.5	45°	1.2	4.3	4.1	11.0	2.4	3.4	3.9
	4.3×13 mm	0.2	0.5	45°	1.2	4.3	4.1	12.5	2.4	3.4	3.9
	4.3×15 mm	0.2	0.5	45°	1.2	4.3	4.1	14.5	2.4	3.4	3.9
	4.3×18 mm	0.2	0.5	45°	1.2	4.3	4.1	17.5	2.4	3.4	3.9
<b>RP 5.0</b>	5.0×7 mm	0.2	0.6	25°	1.6	5.0	4.7	6.5	2.7	3.4	3.9
	5.0×8.5 mm	0.2	0.6	25°	1.6	5.0	4.7	8.0	2.7	3.4	3.9
	5.0×10 mm	0.2	0.6	25°	1.6	5.0	4.7	9.5	2.7	3.4	3.9
	5.0×11.5 mm	0.2	0.6	25°	1.6	5.0	4.7	11.0	2.7	3.4	3.9
	5.0×13 mm	0.2	0.6	25°	1.6	5.0	4.7	12.5	2.7	3.4	3.9
	5.0×15 mm	0.2	0.6	25°	1.6	5.0	4.7	14.5	2.7	3.4	3.9
	5.0×18 mm	0.2	0.6	25°	1.6	5.0	4.7	17.5	2.7	3.4	3.9
<b>WP 5.5</b>	5.5×7mm	0.2	0.6	45°	1.6	5.5	5.3	6.5	3.0	4.4	5.1
	5.5×8.5 mm	0.2	0.6	45°	1.6	5.5	5.3	8.0	3.0	4.4	5.1
	5.5×10 mm	0.2	0.6	45°	1.6	5.5	5.3	9.5	3.0	4.4	5.1
	5.5×11.5 mm	0.2	0.6	45°	1.6	5.5	5.3	11.0	3.0	4.4	5.1
	5.5×13 mm	0.2	0.6	45°	1.6	5.5	5.3	12.5	3.0	4.4	5.1
	5.5×15 mm	0.2	0.6	45°	1.6	5.5	5.3	14.5	3.0	4.4	5.1

All measurements in mm.. Sectional measurements do not necessarily add up to total length  
\*Please note that actual implant length is 0.5 mm shorter than indicated in name.





---

# Surgical procedure

Important considerations	12
Surgical access	13
Drill sequence	14
Depth measurement system	16
Screw taps for implant placement for medium and dense bone	17
Dense bone situations	18
Flapless procedure	20
Flap procedure	21
Implant insertion	24

# Important considerations

**Narrow platform** Limited inter-dental space. Not enough alveolar bone for an RP implant.

**Regular platform** From single anterior tooth loss to fullarch restorations.

**Wide platform** In molar areas a wider platform might be appropriate to maintain proper emergence profile to support the soft tissue.

**Caution** Particular caution should be used when placing narrow platform implants in the posterior region due to risk of prosthetic overload.

## Minimal distances

Approximate minimal distances between implants (in mm) for restorative simplicity taking the average size of the final restoration (incisors, canines, premolars and molars) into account.

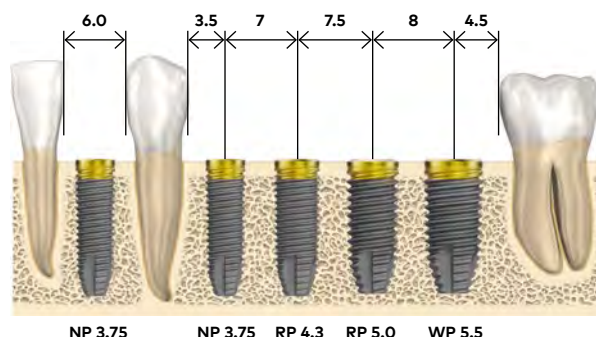

# Surgical access

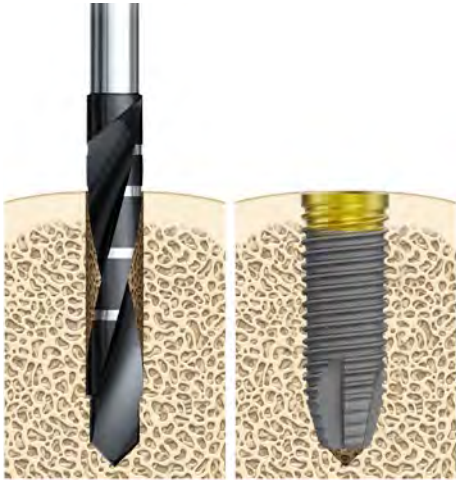

## Standard flap procedure

Used when it is necessary:

- to observe the underlying alveolar bone and adjacent anatomical structures.
- to place bone and/or connective tissue grafts.

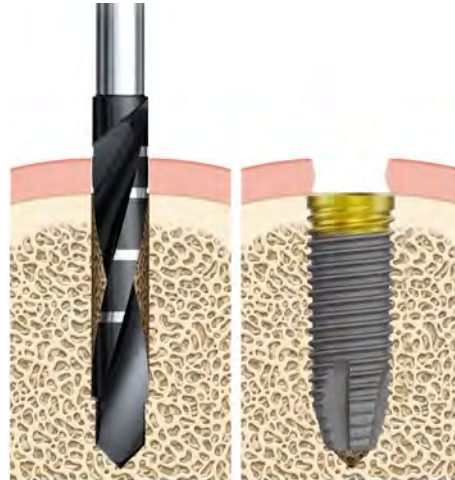

## Flapless procedure

May be used when:

- there is sufficient quantity and quality of alveolar bone and soft tissue.
- it is not necessary to raise a flap to safely direct the drilling procedure in relation to the anatomy.

**Tip** When using a flapless approach add soft tissue height to drill depth.

**Warning** Besides the mandatory precautions for any surgery such as asepsis, during drilling in the jaw bone, one must avoid damage to nerves and vessels by referring to anatomical knowledge and preoperative radiographs.

# DRILL sequence

Demonstration of the drill protocol for a  $\varnothing 4.3 \times 13$  mm implant in soft, medium and dense bone.

## Soft bone



## Medium bone

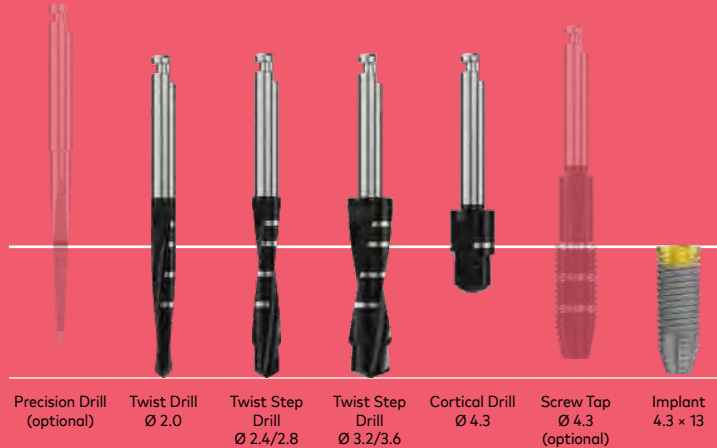

## Dense bone

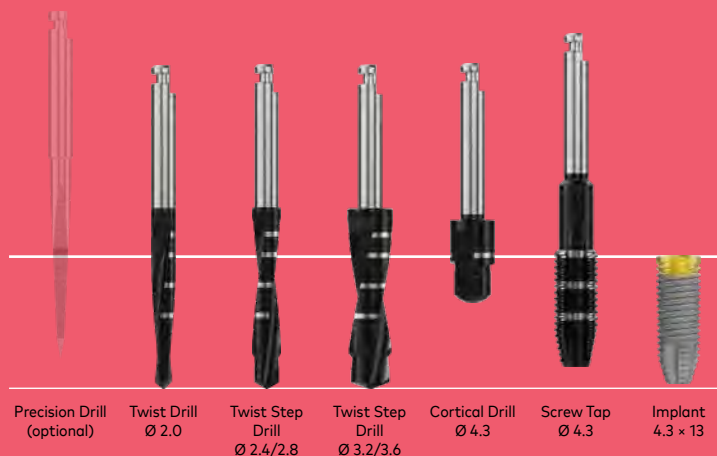

**Recommended drill sequence based on bone quality\***

During drilling procedures bone quality should be considered. Recommended drill sequences are based on bone quality to ensure optimal primary stability when applying One-stage Immediate Function procedures. Drills are used to the full drilling depth.

Drilling must proceed at high speed (max. 2000 rpm for Twist Drills and Twist Step Drills) under constant and profuse irrigation by sterile saline at room temperature.

Platform	Soft bone Type IV	Medium bone Type II–III	Dense bone Type I
<b>NP 3.75</b>	2.0 [2.4/2.8]	2.0 2.4/2.8 Cortical Drill 3.75 [Screw Tap 3.75]	2.0 2.4/2.8 2.8/3.2 Cortical Drill 3.75 Screw Tap 3.75
<b>RP 4.3</b>	2.0 2.4/2.8 [3.2/3.6]	2.0 2.4/2.8 3.2/3.6 Cortical Drill 4.3 [Screw Tap 4.3]	2.0 2.4/2.8 3.2/3.6 Cortical Drill 4.3 Screw Tap 4.3
<b>RP 5.0</b>	2.0 2.4/2.8 3.2/3.6 [3.8/4.2]	2.0 2.4/2.8 3.2/3.6 3.8/4.2 Cortical Drill 5.0 [Screw Tap 5.0]	2.0 2.4/2.8 3.2/3.6 3.8/4.2 Cortical Drill 5.0 Screw Tap 5.0
<b>WP 5.5</b>	2.0 2.4/2.8 3.2/3.6 4.2/4.6 [4.2/5.0]	2.0 2.4/2.8 3.2/3.6 4.2/5.0 Cortical Drill 5.5 [Screw Tap 5.5]	2.0 2.4/2.8 3.2/3.6 4.2/5.0 Cortical Drill 5.5 Screw Tap 5.5

**Note** All data are in mm and the drills within square brackets denoted as optional.

**Preparation of osteotomy**

- In dense bone situations, drill with continuous back and forth motion.
- Move the drill up without stopping the handpiece motor. This allows the irrigation to flush away debris.
- Proceed until the desired depth reference line is reached.
- Screw taps are available for dense bone situations to avoid excessive torque during implant insertion (max. 45 Ncm).

**Tip**

- Stop drilling if there is no irrigation.
- In situations where adjacent natural teeth interfere with the contra-angle head and prevent the drill from reaching the desired depth, a drill extension shaft may be used.
- Drills and Screw Taps are delivered sterile and are for single use only. Do not resterilize.

**Optional Drills**

The drill protocol has been developed to achieve an implant insertion torque between 35 and 45 Ncm for all bone densities. This is to ensure sufficient primary stability to enable immediate function where appropriate.

If bone density is inconsistent (varying between medium and soft or medium and dense bone), optional drills can be added to the drill protocol to ensure the torque level does not exceed 45 Ncm. These optional Twist Step Drills and Screw Taps are denoted above in parentheses.

**Caution**

Never exceed insertion torque of 45 Ncm for the implants. Overtightening an implant may lead to damage of the implant, fracture or necrosis of the bone site.

\* According to classification by Lekholm U, Zarb GA. Patient selection and preparation. In: Brånemark PI, Zarb GA, Albrektsson T, editors: Tissue-integrated prostheses: Osseointegration in clinical dentistry. Quintessence, Chicago, 1985, pp 199-209.

# Depth measurement system

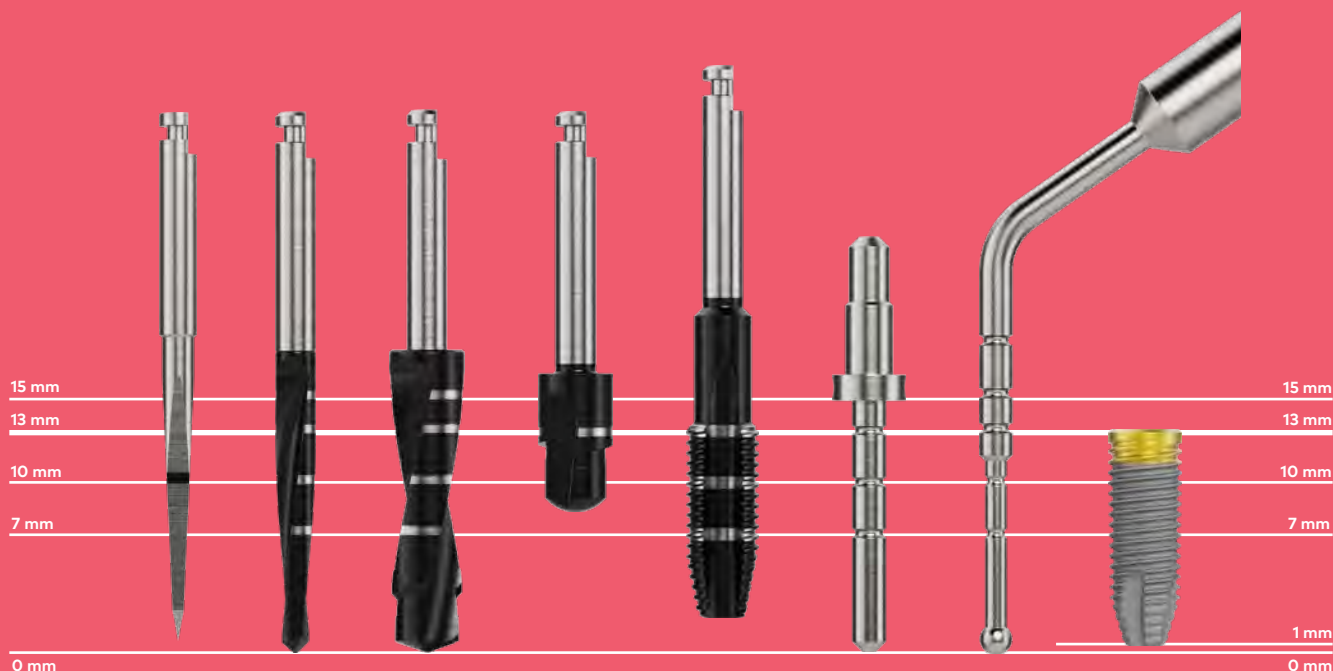

The parallel drills have a true depth measurement system. All drills and components are marked to prepare the site to the correct depth and obtain a secure and predictable position.

Drills are available for implant lengths (laser marks) of 7–10, 7–15 and 10–18 mm. The correct diameter and length of the drills are indicated on the label.

**Note** This surgical procedures manual does not replace the Instructions For Use (IFU). Please review the Instructions For Use, including Indications For Use, Contraindications, Warnings and Cautions before using all products.

**Caution** Twist Drills and Twist Step Drills extend up to 1 mm longer than the implant when seated. Allow for this additional length when drilling near vital anatomical structures.

**Note** The marks on Twist Drills and Twist Step Drills indicate actual millimeter length and correspond to the implant collar. Final vertical positioning depends on several clinical parameters, including esthetics, tissue thickness and available vertical space.

## Twist Drills

Twist Drills are made of stainless steel with an amorphous diamond coating, which gives them their black color. They are used with external irrigation and are available in three lengths: 7–10, 7–15 and 10–18 mm.



# Screw taps for implant placement for medium and dense bone



**Note** In situations where adjacent natural teeth interfere with the contra-angle head and prevent the drill from reaching the desired depth, a drill extension shaft may be used.

# Dense bone situations

## General

In cases of a thick cortical layer or dense bone a Cortical Drill and/or a Screw Tap is mandatory to be able to get the implant fully seated and to release pressure around the implant neck.

Select the Cortical Drill and/or use Screw Tap matching the diameter of the implant.

## Use of a Cortical Drill

To avoid compression around the implant neck, proceed with drilling at high speed max. 2000 rpm and drill to appropriate depth (see [page 16](#)).

**Note** It is not recommended to use a cortical drill for sinus lift procedures. This is in order to maximize the potential for primary stability.

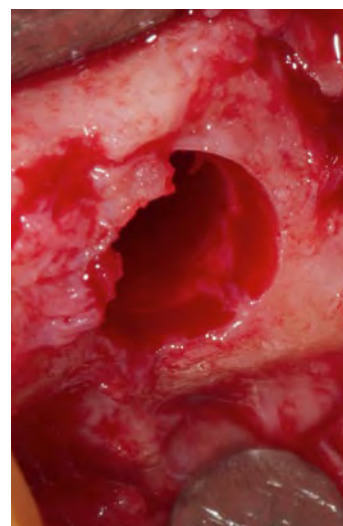

Courtesy of Dr. Claude Authelain, France

## Use of a Screw Tap

If a Screw Tap is used, place the screw tap into prepared implant site using low speed 25 rpm and drill to appropriate depth. Switch the drill device with handpiece to reverse mode and remove the Screw Tap (see [page 16](#)).

**Note** When the depth marking of the screw tap is aligned with the implant length the apical portion is not pre-tapped to allow direct engagement in the apical portion.

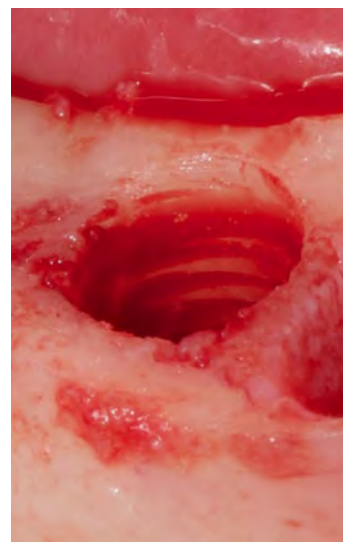

Courtesy of Dr. Claude Authelain, France



# Flapless procedure

Choose between the following two options and continue with the drill sequence on [page 21](#), starting with step 3.

---

## Option A

- Drill to the appropriate depth using the Twist Drill with Tip  $\varnothing$  2 mm. A drill stop can be used.

Maximum speed 2000 rpm

**Note** Measure the soft tissue thickness with the Depth Probe. Add this tissue thickness to the drilling depth for correct site preparation. Be aware of anatomical landmarks.



---

## Option B

- To facilitate initial soft tissue penetration and creation of a crestal starting point (also after flap preparation), the Precision Drill can be used before Twist Drill with Tip  $\varnothing$  2 mm.
- Drill with the precision drill through soft tissue and into the alveolar crest.

Maximum speed 2000 rpm

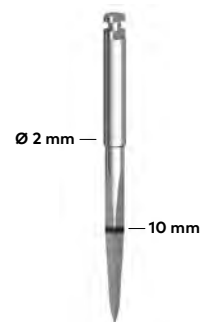
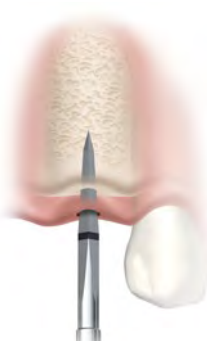

# Flap procedure

The following illustrations show the drill sequence for NobelParallel Conical Connection TiUltra RP 4.3 in medium and dense bone. For other implant diameters and bone densities, see [page 15](#).

---

## 1 Raise a flap

When using a flap procedure, make an incision and raise a flap.



---

## 2 Drill with Precision Drill (optional)

To facilitate creation of a crestal starting point, the Precision Drill can be used before Twist Drill with Tip Ø 2.0 mm.

Maximum speed 2000 rpm



---

## 3 Drill with Twist Drill with Tip Ø 2 mm

Drill to the appropriate depth using the Twist Drill with Tip Ø 2 mm. A drill stop can be used.

Maximum speed 2000 rpm



---

#### 4 Check osteotomy direction (optional)

Check correct direction using Direction Indicator Ø 2.0/2.4–2.8 mm.

#### Note

- If applicable, take a radiograph to verify correct direction.
- When placing multiple implants, proceed to the next implant site before continuing to next drill sequence.



---

#### 5 Drill with Twist Step Drills (optional)

- Continue site preparation using Twist Step Drill Ø 2.4/2.8 mm.
- Check orientation using Direction Indicator Ø 2.0/2.4–2.8 mm.
- Continue site preparation using Twist Step Drill Ø 3.2/3.6 mm.

Maximum speed 2000 rpm



---

#### 6 Drill with Cortical Drill

Finalize site preparation using appropriate Cortical Drill.

#### Note

- In cases of a thick cortical layer or dense bone a Cortical Drill and/or a Screw Tap is mandatory to be able to get the implant fully seated and to release pressure around the implant neck.
- It is not recommended to use a Cortical Drill for sinus lift procedures in order to maximize the potential for primary stability.



Maximum speed 2000 rpm and drill to appropriate depth

For more information about the use of a Cortical Drill, please refer to [page 18](#).



---

### 7 Determine implant length

Use the Depth Probe to verify the desired depth has been achieved (including soft tissue thickness, if applicable).

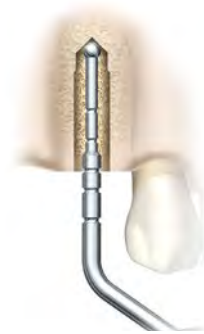

---

### 8 Use of Screw Tap in dense bone

- In cases of a thick cortical layer or dense bone a Cortical Drill and/or a Screw Tap is mandatory to be able to get the implant fully seated and to release pressure around the implant neck.
- Place appropriate Screw Tap into prepared implant site using low speed to appropriate reference line of implant.
- When the threads engage, allow Screw Tap to feed without pressure to defined depth.
- Switch the handpiece to reverse mode and back the Screw Tap out.
- Continue with implant installation until desired position achieved using max. 45 Ncm installation torque.



Low speed 25 rpm

For more information about the use of a Screw Tap, please refer to [page 18](#).

# Implant insertion

## 1 Unpack implant

Each implant is packaged in a double sterile vial system. The outer package has a printed label with product data including diameter and length. Its cap is color-coded to identify the implant diameter. The inner casing is also marked with implant diameter and length.

- Pull the red tab to disengage the plastic shrink-rap film and unscrew the color-coded lid.
- Take out the sterile inner casing and lift off the plastic cap to gain access to implant.
- Record the implant size and LOT number on the patient's chart with the two peel-off labels from the outer vial.



a) Inner vial      b) Plastic vial      c) Blister



d) Implant card

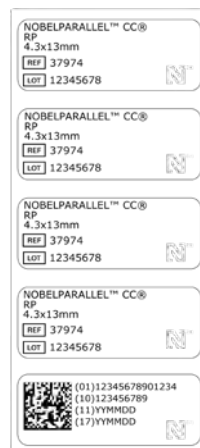

e) Patient record labels



f) Cardboard box

The color of the implant vial cap refers to the diameter of the implant.

## 2 Choose insertion instrument

The implants are ideally installed with low speed, max. 25 rpm, using a drilling device.

- a) With a drilling unit and contra-angle
- b) With Manual Torque Wrench Surgical (optional)

**Note** It is possible to start the implant insertion manually, using the Manual Torque Wrench.

**Caution** Never exceed insertion torque of 45 Ncm for the implants. Overtightening an implant may lead to damage of the implant, fracture or necrosis of the bone site. If a Surgical Driver is used to insert the implant, special care needs to be taken to avoid overtightening.



a) Drilling unit with contra-angle



b) Manual Torque Wrench Surgical

## 3 Pick up implant

Connect the appropriate Implant Driver to the insertion instrument.

Pick up the implant from the inner casing by applying light pressure on the implant driver and carefully turning the casing counter-clockwise until the Implant Driver is fully seated.

**Tip** The Implant Drivers have markings to facilitate the insertion of the driver into the implant.

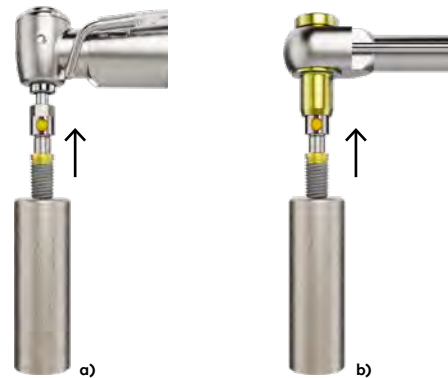

**Tip** Make sure that the Implant Driver is fully seated.

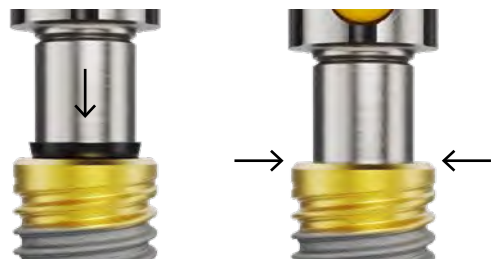

---

#### 4 Machined implant placement

- Begin inserting the implant into the osteotomy.
- When using a drilling unit, start inserting the implant using low speed.

Low speed 25 rpm / Max. torque 45 Ncm

#### Note

- **Caution** Never exceed insertion torque of 45 Ncm for the implants. Overtightening an implant may lead to damage of the implant, fracture or necrosis of the bone site. If a Surgical Driver is used to insert the implant, special care needs to be taken to avoid overtightening.
- **Caution** If the implant gets stuck during implant installation or 45 Ncm of insertion torque is achieved before it is fully seated, rotate the implant counterclockwise using drilling device (reverse mode) or Manual Torque Wrench and remove the implant from site. Replace the implant back into the inner casing before proceeding further.
- Use Screw Tap to widen the osteotomy as outlined in step 8 ([page 23](#)) of the drill section.
- Pick up and insert the implant again as outlined in steps 3 and 4 above.



## 5 Manual implant placement

- Connect the Manual Torque Wrench Surgical to the Manual Torque Wrench Adapter and place the implant to final depth.
- For immediate function, the implant should withstand a final insertion torque of at least 35 Ncm. Do not exceed 45 Ncm.
- Remove Implant Driver.
- If the Implant Driver is difficult to remove, slightly rotate it counter-clockwise before disengaging.



## If experiencing strong resistance

Excessive torque while inserting the implant must be avoided. It can cause deformation of the implant or connection and may result in excessive compression of the bone.

If strong resistance (max 45 Ncm) is encountered at any point during insertion, remove the implant and place it back into the inner casing. Widen the implant site according to the drill protocol or use Screw Tap matching the diameter of the implant.



Markings for 15 Ncm, 35 Ncm and 45 Ncm.

## 6 Final implant placement (optional)

- For maximum esthetic results, place the implant on the level of the buccal bone or 0.5 – 1 mm below (A).
- When placing the implant, align one of the black hex indicators on the implant driver parallel to the buccal wall. This ensures that one of the flat sides of the hexagon is parallel to the buccal side (B), ensuring preferred prosthetic abutment orientation.

**Note** The implant driver has a 3 mm height indicator to facilitate vertical implant positioning and six black lines correlating to the flat sides of the implant hexagon (C).



a)

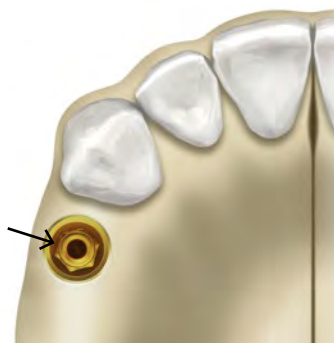

b)

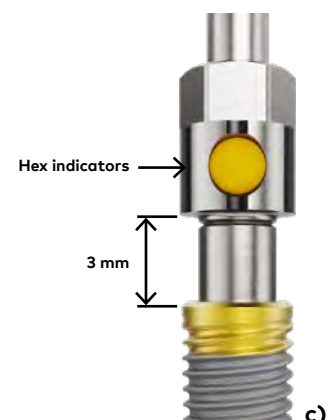

c)





---

# Restorative procedure

Important considerations	30
Finalization of implant surgery and temporary restorations	34
Two-stage early/delayed function	35
One-stage early/delayed function	35
One-stage Immediate Function procedures	36
NobelParallel Conical Connection TiUltra WP posterior solution	40

# Important considerations

## Prosthetic interface

- Dual-function prosthetic connection: internal conical connection for abutments and external platform for implant-level bridge restorations.
- Built-in platform shift



Conical seal for abutments



Shoulder seating for NobelProcera Implant Bridge

## Multiple-unit restorations

When restoring with a NobelProcera Implant Bridge, or any other full-arch solution, Healing Abutments Bridge and Impression Copings Bridge must be used for placement, uncovering and impression taking.



## Impression coping seating

Proper seating of the impression coping is essential for a correct impression.

To verify that the impression copings are properly seated, check that the groove on the impression coping sits right at the level of the implant shoulder. Use a perpendicular radiograph if necessary.

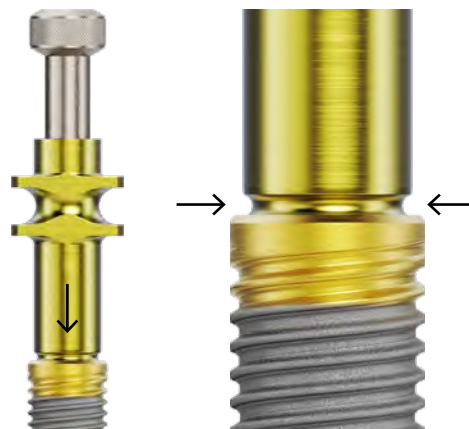

### Abutment seating

Correct positioning of the abutment is essential for the prosthetic outcome and long-lasting function. Verify correct vertical abutment seating by using radiographic imaging.

- Position the abutment into the implant head and make sure the hexagonal extension engages properly by gently turning and pushing.
- Make sure the abutment feels secure in place horizontally and vertically.
- Tighten the screw, but not to full torque.
- Take a radiograph to verify proper and full abutment seating:
  - No apparent bone interference
  - Alignment of long axes of implant and abutment
  - No gap in conical interface
- Space at the bottom of the connection should appear parallel and measure less than 1 mm.
- Tighten the abutment screw to final torque. Tightening torque for NP, RP and WP abutments is 35 Ncm.

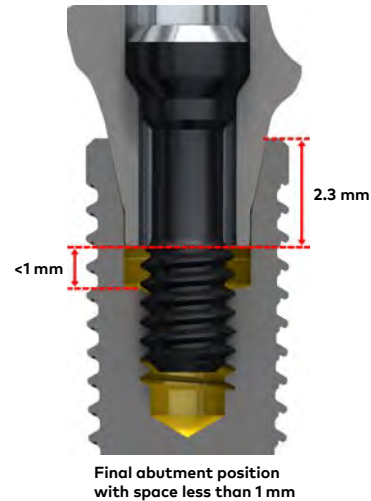

**Note** This surgical procedures manual does not replace the Instructions For Use (IFU). Please review the Instructions For Use, including Indications For Use, Contraindications, Warnings and Cautions before using all products.

Reference images show NobelActive®. Same applies to NobelParallel CC TiUltra.

### Example 1

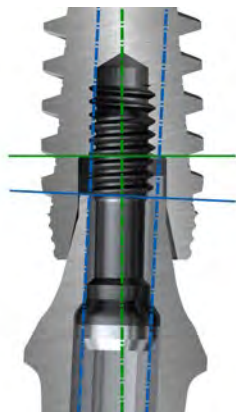

Abutment not fully seated due to interfering bone. Long axes are not aligned. Gap in conical interface. Bottom space is not parallel and is larger than 1 mm.

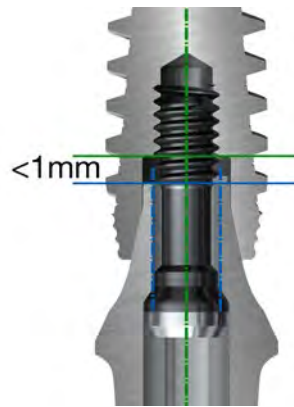

Abutment fully seated. All above parameters are verified.

### Example 2

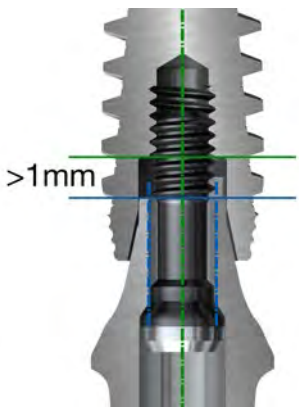

Abutment seems to be aligned with implant but space is larger than 1 mm.

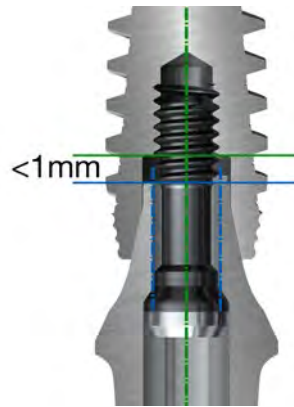

Abutment is fully seated.



# Finalization of implant surgery and temporary restorations

There are three options for finalizing the implant surgery.



## Two-stage early/delayed function

Use Screwdriver UniGrip to connect a cover screw to the implant. Suture the tissue flap using the desired technique.



## One-stage early/delayed function

Place the On1 Base Seal and connect the On1 Healing Cap to it. Or connect a healing abutment directly to the implant. If applicable, suture back the soft tissue.

For further information on this option, please check the [On1 concept Quick guide](#)



## One-stage Immediate Function

Provisionalize the implant for immediate esthetics and function, using Nobel Biocare On1 Temporary Abutments or implant-level temporary abutments.

**Note** If the final restoration is an implant-level NobelProcera Implant Bridge, non-engaging Universal Abutment or non-engaging GoldAdapt Abutment, use a Healing Abutment Bridge to prevent tissue overgrowth on the horizontal implant platform.

# Two-stage early/delayed function

## 1 Uncover the implant

- Make an incision to expose the cover screw or use the Soft Tissue Punch if there is a sufficient amount of attached mucosa.
- Remove the cover screw using a Screwdriver Manual Unigrip.

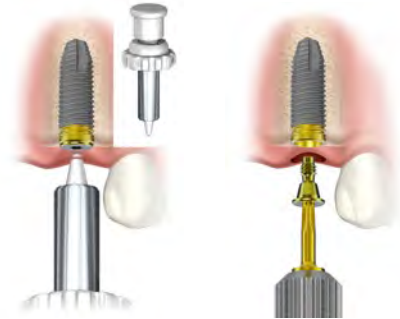

## 2 Remove bone overgrowth

- In cases of bone growing over the cover screw, remove the bone with a rotating instrument and/or a curette. Be careful not to damage the seating for the Screwdriver Manual Unigrip.
- After removing the cover screw, remove any bone around the implant platform that will hinder an abutment being fully seated on the implant platform. This is often the case when the implant has been placed below the bone crest. For bone removal, use the Bone Mill Guide and Bone Mill for the corresponding platform.
- The Bone Mill can be handled either manually (with the handle for machine instruments) or with the drilling machine.



# One-stage early/delayed function

## 1 Connect healing abutment

- Connect a suitable healing abutment to the implant using the Screwdriver Manual Unigrip.
- If a flap is prepared, suture back the soft tissue.

**Alternative** If possible, connect the final abutment using corresponding screwdriver.

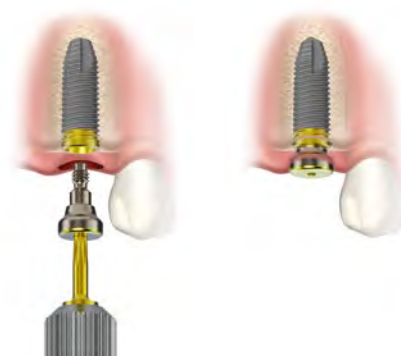

# One-stage Immediate Function procedures

## Implant level, temporary single-unit restoration

The following illustrations show the use of the Temporary Snap Abutment Engaging (for single-unit restorations).

Provisionalization must be done in Immediate Function cases and is also a common option to altering the soft tissue after a healing abutment has been used (soft tissue management).

### 1 Connect abutment to implant

- Attach the abutment onto the implant, check inter-occlusal space and adjust for height and clearance if necessary.
- Modifications of the abutment can be performed with a carborundum disk or carbide bur using copious irrigation. Extraoral modification of abutment is recommended.
- Place the abutment onto the implant and block the screw channel. Do not insert the screw, as the abutment is retained by the retention elements.



### 2 Fabricate the temporary crown conventionally (Option A)

- Using the acrylic mold, create the temporary crown, filling it with dental acrylic or composite material, and seat it over the temporary abutment.
- Follow the material manufacturer's instructions regarding curing.
- Finalize the restoration following the conventional procedure. It is important to have a smooth surface adjacent to the surrounding soft tissue.
- Create the screw access hole using the Apical Drill and Protection Analog/Drill Guide.

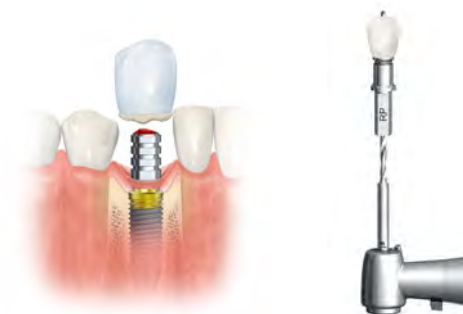

OR



---

## 2 Fabricate the temporary crown with a TempShell (Option B)

- Use a TempShell to convert it into an individualized provisional restoration designed prior to surgery.
- Try-in the fit of the temporary crown seating the wings on the neighboring teeth.
- Apply small amount of acrylic or composite into the crown and reposition it in the patient's mouth.
- Let the acrylic or composite cure and pick up the restoration.
- Finalize the crown by filling the shell with the acrylic/composite, remove the wings and polish the restoration. It is important to have a smooth surface adjacent to the surrounding soft tissue.
- Create the screw access hole using the Apical Drill and Protection Analog/Drill Guide.

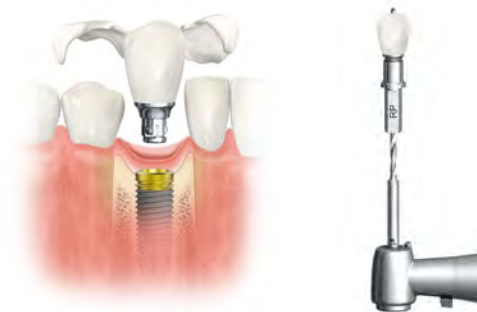

---

## 3 Connect temporary restoration

- Connect the restoration and tighten it to 35 Ncm using the clinical screw and Screwdriver UniGrip.
- Block the screw access hole using Teflon tape and close it with composite.
- Fill the screw access hole with suitable material.

**Tip** The recommended tightening torque is max. 35 Ncm.

**Caution** Never exceed the recommended maximum tightening torque for the abutment screw. Overtightening of the abutment may lead to a screw fracture.



## Implant level, temporary multiple-unit restoration

The following illustrations show the use of the Temporary Abutment Non-Engaging (for multiple splinted restorations). For individual implants, use engaging abutments.

Provisionalization must be done in Immediate Function cases and is a common option for altering the soft tissue after a healing abutment has been used (soft tissue management).

### 1 Connect abutments to implants

- Attach the abutments onto the implants and adjust for height and clearance if necessary.
- Fasten the abutments with guide pins that extend beyond the occlusal plane with the Screwdriver Manual UniGrip.

**Note** Abutment screw is included with the abutment. The guide pin (available in two lengths: 20 mm [standard length] and 30 mm) has to be ordered separately.



### 2 Fabricate the temporary bridge using a TempShell (Option A)

- Use a TempShell to convert it into an individualized provisional restoration designed prior to surgery.
- Try-in the fit of the temporary bridge seating the wings on the neighboring teeth.
- Apply a small amount of acrylic or composite into the bridge and reposition it in the patient's mouth.
- Let the acrylic or composite cure and pick up the restoration.
- Finalize the bridge by filling the shell with the acrylic/composite, remove the wings and polish the restoration. It is important to have a smooth surface adjacent to the surrounding soft tissue.
- Create the screw access hole using the Apical Drill and Protection Analog/Drill Guide.

OR

---

## 2 Make acrylic template (Option B)

- Fabricate the template from acrylic or composite for chairside temporization.
- Make access holes to allow guide pins to protrude.
- If the laboratory has made a prefabricated provisional bridge, make access holes to allow the guide pins to protrude (if not already done) and adjust it to the abutments.
- Fill template with acrylic or composite and seat it over the temporary abutments.



---

## 3 Adjust temporary restoration

- After seating, loosen the guide pins to remove the restoration.
- Trim and polish the restoration. It is important to have a smooth surface adjacent to the surrounding soft tissue.

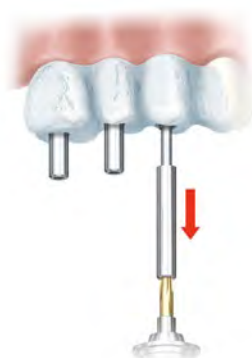

---

## 4 Connect temporary restoration

- Connect the provisional restoration with the supplied abutment screws.
- Tighten to 35 Ncm using Manual Torque Wrench Prosthetic and Screwdriver Machine UniGrip.
- Fill the screw access holes with suitable material.



# NobelParallel Conical Connection TiUltra WP posterior solution

## Temporary single-unit restoration, cement-retained (chairside procedure)

The following illustrations show the use of the Temporary Abutments Anatomical PEEK (available for Wide Platform only). Please see also Instructions For Use for Anatomical PEEK Healing/Temporary Abutment.

### Indications

Temporary Abutments Anatomical PEEK are indicated for use with single-unit and multiple-unit cement-retained temporary dental prostheses placed on endosseous dental implants in the maxilla and mandible, for up to 180 days.

### Provisionalization

Provisionalization must be done in Immediate Function cases and is also a common option for altering the soft tissue after a healing abutment has been used (soft tissue management).

---

#### 1 Connect abutment to implant and modify if necessary, outside of the patient mouth

- Select appropriate temporary abutment and check interocclusal space. Height and gingival margin may be adjusted by the use of rotary instrument (e.g. carbide or acrylic bur).
- Cut a small axial 'flat' or 'groove' into the temporary abutment to assure correct position of temporary crown during cementation.
- Attach the abutment onto the implant and tighten with the Screwdriver Manual Unigrip.



**Note** The recommended tightening torque is 35 Ncm.

**Caution** Never exceed the recommended maximum tightening torque for the abutment screw. Overtightening of the abutment may lead to a screw fracture.

---

## 2 Block the screw access hole

- Place a resilient material of choice (gutta-percha, silicone or temporary filling material) into the screw access hole and fill the remaining channel with composite or another material of choice. This allows for easy access to the abutment screw in the future.
- Apply a separating solution onto the plastic abutment in preparation for fabricating the temporary crown.



---

## 3 Fabricate temporary crown

- Try-in the shell crown and modify following conventional procedures.
- Fill the shell crown with acrylic in preparation for doing a reline.
- Remove the excess acrylic and polish modified areas.





---

## 4 Cement the temporary crown

Make final adjustments, polish and secure with temporary cement.

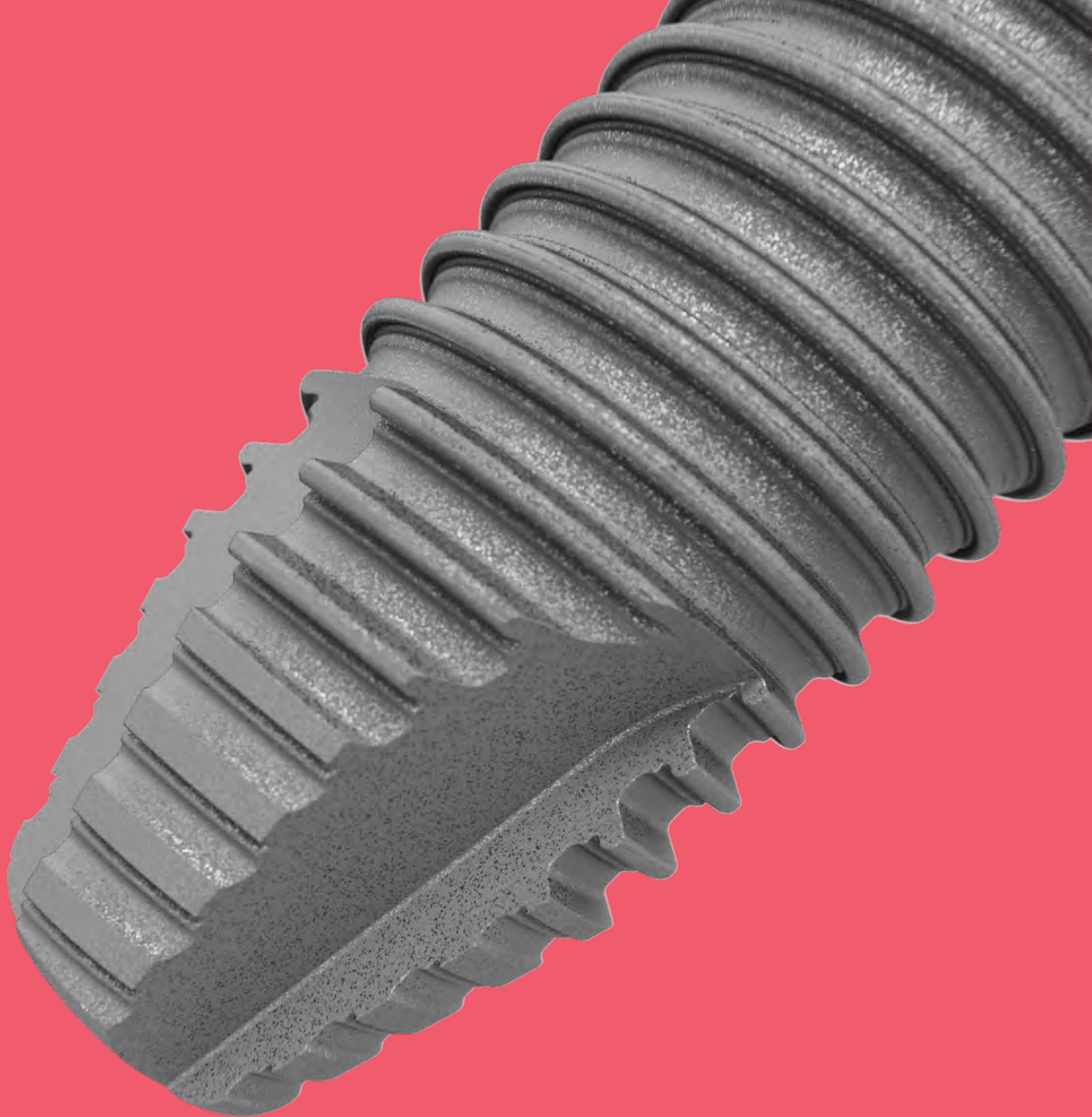

**Caution** In a fresh/open wound, avoid getting any cement below the soft tissue or remove it carefully. Consider using rubber dam or other options to prevent excess cement.



---

# PureSet™

Wallchart 44





Depth Probe 7-18 mm  
37791



Precision Drill  
36118



**Bone Mill (with Guide) CC**  
NP Ø4.4 37863  
NP Ø5.2 37864  
RP Ø5.2 37866  
RP Ø6.2 37867  
WP Ø6.7 37869



**Bone Mill Guide CC**  
NP 37865  
RP 37868  
WP 37870

NobelActive®/  
NobelParallel™ CC  
PureSet™ Tray  
PUR0200



Direction Indicator  
32112



Screwdriver  
Manual UniGrip 28 mm  
29149\*

**SINGLE USE ONLY**

**N™**

**Precision**  
Ø1.5    Ø2.0

**#1**    **#2**

**Guide**  
Ø4.0    Ø2.4/2.8

**#3**

**Direction Indicator**

**Screw Tap**  
Ø3.0    Ø3.5

**Bone Mill**  
Ø5.2    Ø3.2/3.6

**#4**    **#5**

**Guide**  
Ø5.2    Ø3.8/4.2

**#6**

**Cortical Drill**  
Ø3.75

**Screw Tap**  
Ø4.2/4.6

**#7**

**Implant Driver**  
3.0    NP

**#8**  
Ø4.2/5.0

# Wallchart



**Twist Drills**

- Ø 2.0(7-10) 32296
- Ø 2.0 (7-15) 32297
- Ø 2.0(10-18) 32299

**Twist Step Drills**

- 7-10 mm**
- Ø 2.4/2.8 (#3) 32260
- Ø 2.8/3.2 (#4) 37873
- Ø 3.2/3.6 (#5) 32263
- Ø 3.8/4.2 (#6) 32275
- Ø 4.2/4.6 (#7) 37874
- Ø 4.2/5.0 (#8) 37875

**7-15 mm**

- Ø 2.4/2.8 (#3) 32261
- Ø 2.8/3.2 (#4) 34638
- Ø 3.2/3.6 (#5) 32264
- Ø 3.8/4.2 (#6) 32276
- Ø 4.2/4.6 (#7) 34582
- Ø 4.2/5.0 (#8) 37876

**10-18 mm**

- Ø 2.4/2.8 (#3) 32262
- Ø 2.8/3.2 (#4) 34639
- Ø 3.2/3.6 (#5) 32265
- Ø 3.8/4.2 (#6) 32277
- Ø 4.2/4.6 (#7) 34583



Drill Extension Shaft  
29164

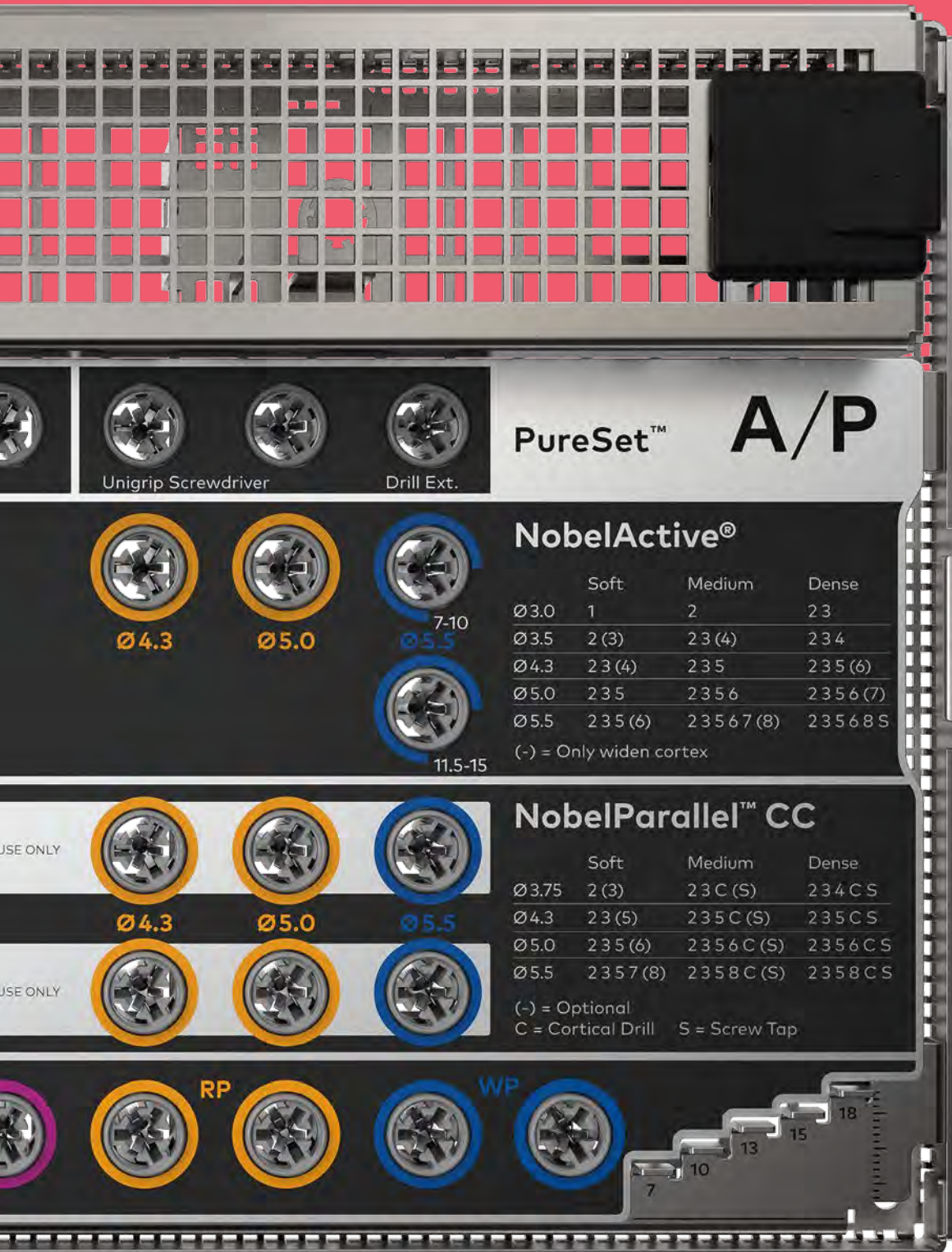

NobelReplace Manual  
Torque Wrench Surgical  
28839

PureSet™ A/P

Unigrip Screwdriver

Drill Ext.

NobelActive®



	Soft	Medium	Dense
Ø3.0	1	2	23
Ø3.5	2 (3)	23 (4)	234
Ø4.3	23 (4)	235	235 (6)
Ø5.0	235	2356	2356 (7)
Ø5.5	235 (6)	23567 (8)	23568 S

(-) = Only widen cortex

NobelParallel™ CC



	Soft	Medium	Dense
Ø3.75	2 (3)	23 C (S)	234 C S
Ø4.3	23 (5)	235 C (S)	235 C S
Ø5.0	235 (6)	2356 C (S)	2356 C S
Ø5.5	2357 (8)	2358 C (S)	2358 C S

(-) = Optional  
C = Cortical Drill S = Screw Tap



**Cortical Drill**  
NP 3.75 38000  
RP 4.3 38001  
RP 5.0 38002  
WP 5.5 38003



**Screw Tap**  
NP 3.75 (7-13) 37990  
NP 3.75 (7-18) 37991  
RP 4.3 (7-13) 37992  
RP 4.3 (7-18) 37993  
RP 5.0 (7-13) 37994  
RP 5.0 (7-18) 37995  
WP 5.5 (7-10) 37996  
WP 5.5 (7-15) 37997



**Implant Driver NP**  
28 mm 36718  
37 mm 36719



**Implant Driver RP**  
28 mm 36720  
37 mm 36721



**Implant Driver WP**  
28 mm 37859  
37 mm 37860

\* Available in other lengths

**NobelParallel™ Conical Connection PureSet™ 87295**

(The articles below can also be purchased individually)

NobelActive /NobelParallel CC PureSet Tray	PUR0200
Implant Driver Conical Connection NP 28 mm	36718
Implant Driver Conical Connection NP 37 mm	36719
Implant Driver Conical Connection RP 28 mm	36720
Implant Driver Conical Connection RP 37 mm	36721
Implant Driver Conical Connection WP 25 mm	37859
Implant Driver Conical Connection WP 37 mm	37860
Screwdriver Manual Unigrip™ 28 mm	29149
Drill Extension Shaft	29164
Direction Indicator Ø2/Ø2.4–2.8 mm (4x)	32112
Implant/Prosthetic Organizer	29532
NobelReplace® Manual Torque Wrench Surgical	28839
Depth Probe 7–18mm Z-shaped	37791
Implant Sleeve Holder	29543
NobelParallel™ CC Radiographic Template	37792
NobelActive / NobelParallel CC PureSet Wall Chart	300565

**Note** Drills and Screw Taps are available for separate purchase and are not included in the kit.

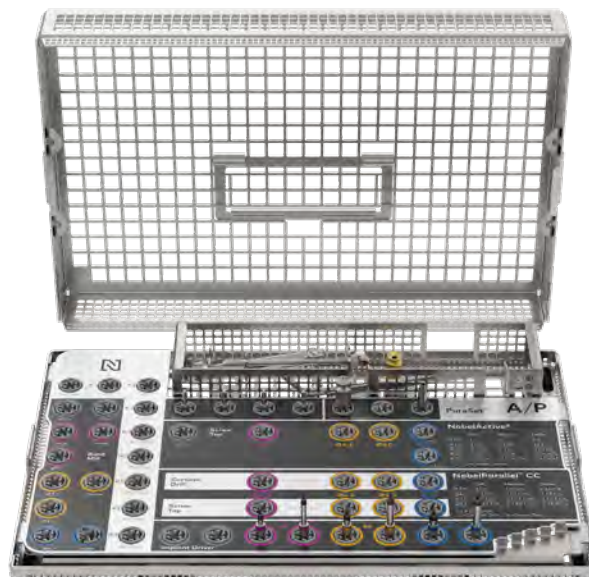
**Bone Mill with Guide Conical Connection**

(To be accommodated in the PureSet™)

Bone Mill with Guide Conical Connection NP Ø4.4	37863
Bone Mill with Guide Conical Connection NP Ø5.2	37864
Bone Mill with Guide Conical Connection RP Ø5.2	37866
Bone Mill with Guide Conical Connection RP Ø6.2	37867
Bone Mill with Guide Conical Connection WP Ø6.7	37869



For more information regarding the product portfolio see the 'Product Overview - Conical Connection Implants & Prosthetics'.





---

# Appendices

Manual Torque Wrench 50

Cleaning and sterilization 52



# Manual Torque Wrench

For the surgeon, the torque required to place implants provides insight into the primary stability of the implant. For restorative procedures, tightening the abutment and prosthetic screws to the recommended torque specifications will more effectively control screw-joint integrity during patient function.

## Manual Torque Wrench – Surgical

Manual Torque Wrenches Surgical are indicated for use with Nobel Biocare dental implant drivers to ensure that the desired torque is achieved during implant placement. They are also indicated to be used with implant retrieval instruments and abutment screw retrieval instruments. Manual Torque Wrenches Surgical can be used as an alternative to machine torque wrenches.

- Indicating torque values 15 Ncm and 35 Ncm
- Insert Implant Driver Conical Connection



## Manual Torque Wrench – Prosthetic

Manual Torque Wrenches Prosthetic are indicated for use with Nobel Biocare abutments and abutment screws to ensure that the desired torque is achieved during placement or removal of the abutment or screw. Manual Torque Wrenches Prosthetic can be used as an alternative to machine torque wrenches.

- Indicating torque values 15 Ncm and 35 Ncm
- Compatible with all machine screwdrivers.
- Insert the applicable driver



### Use of the Manual Torque Wrench Surgical

- Select the corresponding Manual Torque Wrench Adapter Surgical and insert the corresponding Implant Driver into the adapter.
- To tighten an implant
  - Twist the knob to ensure that the arrow is pointing in clockwise direction before tightening.
  - Rotate the wrench clockwise as far as possible, and then release the handle in counterclockwise direction (indicated by noise of ratchet)
- To loosen an implant, adjust the direction indicator in the reverse (counter clockwise) direction. Pull the knob and simultaneously rotate it so that the arrow is pointing counter clockwise direction.

**Note** Using the wrench body instead of the level arm may result in excessive torque being transferred to the screw and/or implant site.

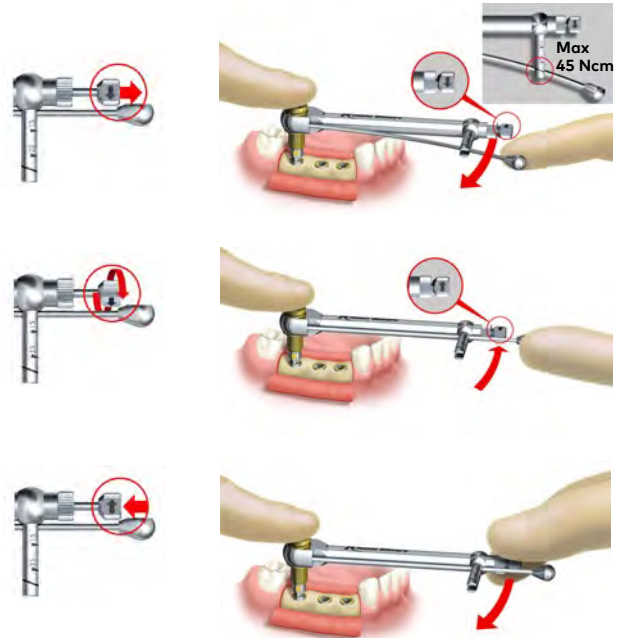

# Cleaning and sterilization

## Sterile components

Refer to the Instructions For Use (IFU1078) for NobelParallel CC TiUltra for detailed cleaning and sterilization instructions.

[ifu.nobelbiocare.com](http://ifu.nobelbiocare.com)

**Note** Implants must never be resterilized or reused.

### Implants

Implants are delivered sterile, are for single use only, and must be used prior to the labeled expiration date. Do not use implants if the packaging has been damaged or previously opened.

**Warning** Do not use device if the packaging has been damaged or previously opened.

**Caution** NobelParallel CC TiUltra implants are single use products and must not be reprocessed. Reprocessing could cause loss of mechanical, chemical and / or biological characteristics. Re-use could cause cross contamination.

### Twist and Twist Step Drills, Precision Drill and Screw Taps

Twist Drills and Twist Step Drills are delivered sterile and for single use only. Screw Taps are delivered sterile and reusable.

**Note** This surgical procedures manual does not replace the Instructions For Use (IFU). Please review the Instructions For Use, including Indications For Use, Contraindications, Warnings and Cautions before using all products.





## Non-sterile components

**Caution** Care and maintenance of instruments are crucial for a successful treatment. Sterilized instruments not only safeguard your patients and staff against infection but are also essential for the outcome of the total treatment.

Refer to the Instructions For Use for pureset for detailed cleaning and sterilization instructions.

[ifu.nobelbiocare.com](http://ifu.nobelbiocare.com)



### Abutments and plastic copings

Refer to the Instructions For Use for the abutment or coping for detailed cleaning and sterilization instructions.

[ifu.nobelbiocare.com](http://ifu.nobelbiocare.com)

**Note** If any temporary abutment or coping is modified after initial cleaning and sterilization, the device must be cleaned and sterilized again prior to intraoral use.



---

### Order online

Order our complete range of implants and prefabricated prosthetics 24 hours a day through the Nobel Biocare online store.

[store.nobelbiocare.com/us/en](https://store.nobelbiocare.com/us/en)

---

### Order by phone

Contact your sales representative or call our customer service team.

800 322 5001

---

### Lifetime warranty

The warranty covers all Nobel Biocare implants including prefabricated prosthetic components.

[nobelbiocare.com/warranty](https://nobelbiocare.com/warranty)



[nobelbiocare.com/en-us/nobelparallel](https://nobelbiocare.com/en-us/nobelparallel)

