

Procedures manual



NobelPearl™



The scope of this surgical procedures manual is to provide a comprehensive overview of the surgical steps and options during the placement of NobelPearl™. This surgical procedures manual does not replace the Instructions For Use (IFU). Please review the Instructions For Use, including Indications For Use, Contraindications, Warnings and Cautions before using the products. Instructions For Use are available at:

ifu.nobelpearl.zeramex.com

For a full list of article numbers and for ordering information, refer to nobelbiocare.com or contact a Nobel Biocare representative.

Note In order to improve readability, Nobel Biocare does not use ™ or ® in the running text. By doing so, however, Nobel Biocare does not waive any right to the trademark or registered mark and nothing herein shall be construed to the contrary.

Disclaimer Some products may not be regulatory cleared, released or licensed for sale in all markets. Please contact the local Nobel Biocare sales office for current product assortment and availability.

Contents

Introduction 5

Implant specifications 6

Surgical procedure 11

Case planning in five steps 12

Distances at bone level 13

Depth measurement 14

Drill sequence 15

Implant insertion 21

Restorative procedure 25

Soft tissue management 26

Digital impression taking 28

Conventional impression taking 30

Prosthetic workflow 34

Screw-retained prosthetic restoration 35

Cement-retained prosthetic restoration 39

Platform switching 40

Screw-retained prosthetic restoration CAD/CAM 41

NobelPearl Docklocs® Abutments 44

Technical data for NobelPearl abutments 46

Grinding Standard Abutments 48

Technical data for NobelPearl screws 50



Introduction

Implant specifications 6

Two-piece flexibility

NobelPearl offers greater restorative flexibility compared with one-piece or cemented ceramic implants. This is thanks to the two-piece, reversible, cement-free internal connection design.

Internal connection designed for ceramics

The abutment's simple placement and secure seating is enabled by the connection's high-precision geometry. The slightly beveled contact surface of the implant platform is designed to facilitate centering of the prosthetic components while the four interlocks prevent abutment rotation within the implant. The interlocks remain unloaded.

Precision manufacturing

NobelPearl implants and abutments are milled from hot isostatic-pressed (HIP) zirconium dioxide ATZ blanks, which are proven to be strong. No thermal process (sintering) or finishing takes place after the final shaping of the external and internal implant geometry. This manufacturing method enables a high level of dimensional precision and accuracy.

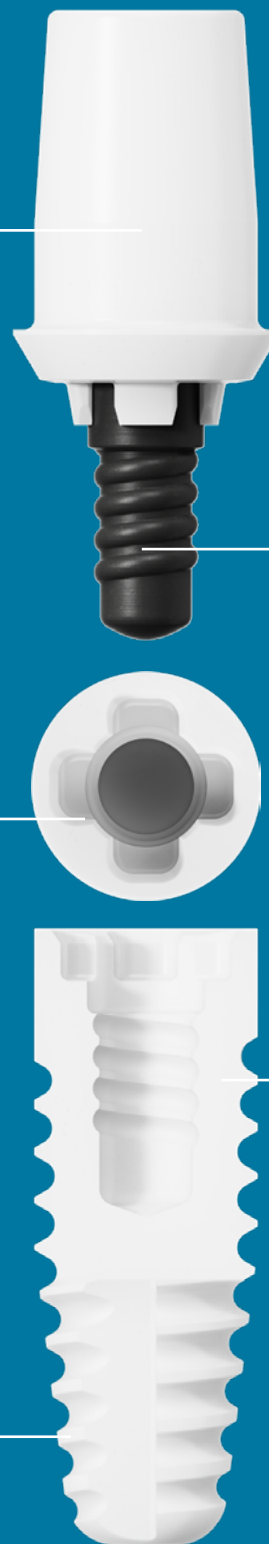

Implant

specifications

High performance metal-free screw

The innovative metal-free VICARBO® screw is made of carbon fiber-reinforced polymer and designed for a strong ceramic-to-ceramic connection.

- Metal-free – no metal inserts or metal abutment screws
- Cement-free* – avoiding the risks of intraoral cementation



Screw head Ø 2.8 mm

Proven ZERAFIL™ surface

The hydrophilic sand-blasted and acid-etched ZERAFIL™ surface, combined with a partially machined collar, is proven to osseointegrate.

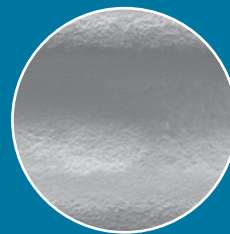

500 µm

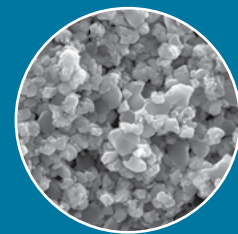

2 µm

Engineered for primary stability

The thread design and tapered implant shape combined with the tapered drill protocol are designed to achieve high primary stability. The reservoir for bone chips at the apex of the implant is designed to facilitate implant insertion.

* Cement-free internal connection, screw-retained prosthetics available.

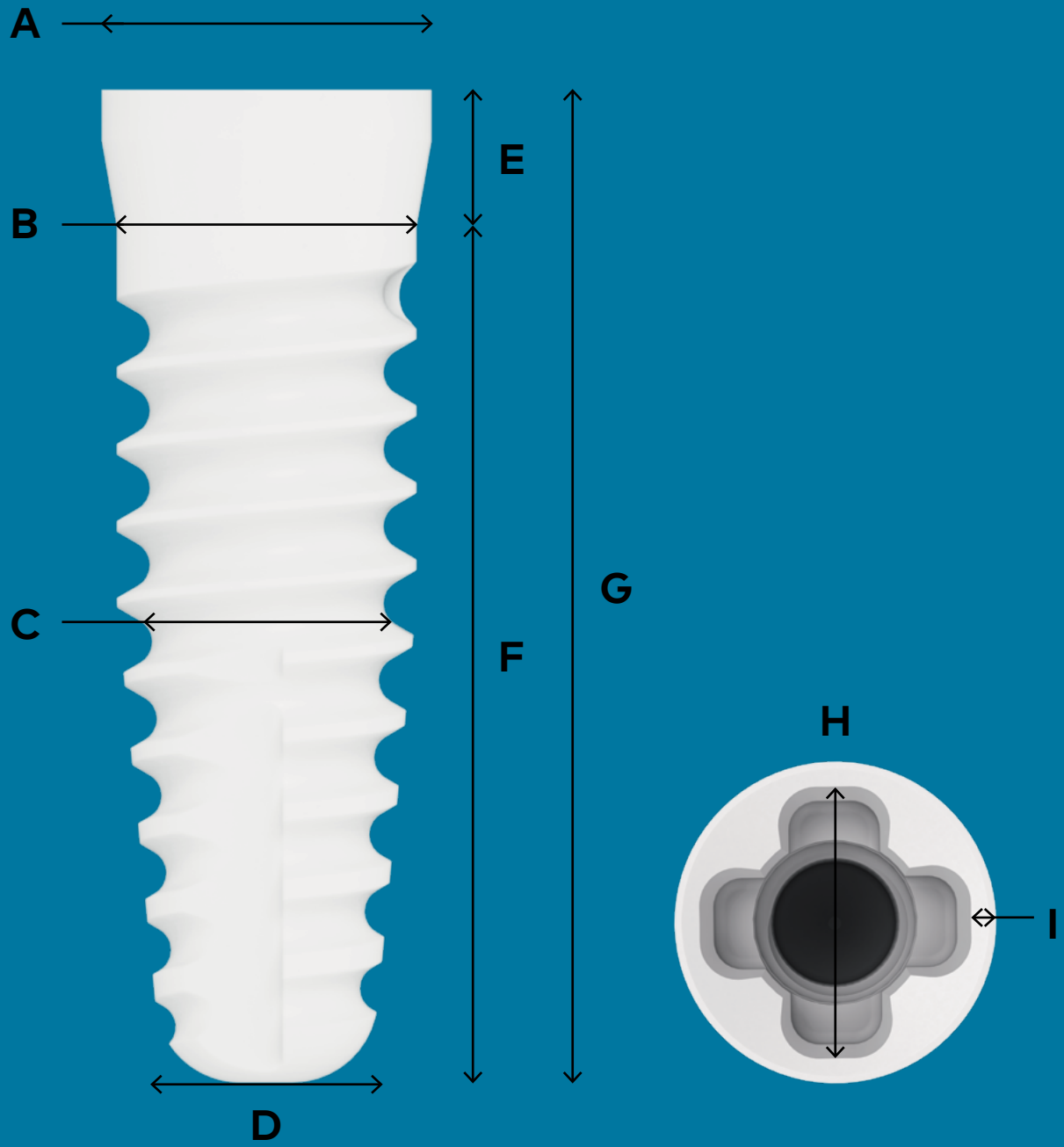

**NP
3.5**



**RP
4.2**



**WP
5.5**



Platform		A Platform diameter	B Major diameter	C Body diameter	D Apex diameter	E Collar height	F Thread height	G Total length	H Abutment interface	I Flat ring
NP 3.5	3.5 × 8 mm	3.85	3.5	2.7	2.4	1.6	8	9.8	3	0.25
	3.5 × 10 mm	3.85	3.5	2.7	2.4	1.6	10	11.6	3	0.25
	3.5 × 12 mm	3.85	3.5	2.7	2.4	1.6	12	13.6	3	0.25
RP 4.2	4.2 × 8 mm	4.2	4.2	3.4	2.9	1.6	8	9.6	3	0.65
	4.2 × 10 mm	4.2	4.2	3.4	2.9	1.6	10	11.6	3	0.65
	4.2 × 12 mm	4.2	4.2	3.4	2.9	1.6	12	13.6	3	0.65
	4.2 × 14 mm	4.2	4.2	3.4	2.9	1.6	14	15.6	3	0.65
WP 5.5	5.5 × 8 mm	5.5	5.5	4.7	3.5	1.6	8	9.6	3	1.25
	5.5 × 10 mm	5.5	5.5	4.7	3.5	1.6	10	11.6	3	1.25
	5.5 × 12 mm	5.5	5.5	4.7	3.5	1.6	12	13.6	3	1.25

All measurements in millimeters.

Surgical procedure

Case planning in 5 steps 12

Distances at bone level 13

Depth measurement 14

Drill sequence 15

Implant insertion 21

Case planning in five steps

1 Preparation phase

As with any surgical procedure, implantation also requires proper professional preparation. Preparation includes a thorough dental and general health examination which includes taking X-ray images and a detailed discussion with the patient regarding their prior medical history. Conventional, prosthetic and periodontal preparatory treatment should be completed before initiating the implant therapy. The options and intentions for later prosthetic restoration (item 5) should be included in the discussion from the start. Use this baseline to work out the individual therapy plan and create a protocol. CT and DVT can be used to gather information about bone conditions which are difficult to diagnose. The bone and its quality decide ultimately on the position and number of implants.

2 Implant selection

Implant length and diameter are based on X-ray images. Always use the implant with the largest possible diameter. The vestibular wall thickness must be at least 1 mm, however, to preserve adequate blood circulation. If this is not possible, bone grafting will be necessary.

3 Bone preparation

It is essential to follow the drilling protocol starting on page 18. You must provide constant cooling during drilling because temperatures higher than 42 °C may alter bone structure and affect osseointegration!

Important Insert the drill only to the specified marking. The implant is not self-tapping; always use a screw tap. If the cortical bone is very hard, use the NobelPearl Tapered Dense Bone Drill. Follow the corresponding drilling protocols. Replace drills after about 20 implantations or in case of reduced cutting performance.

4 Implant insertion

We recommend tightening the implant by hand and not tightening at more than 15 rpm. The implant is placed 1.6 mm supracrestal, but can optionally be sunk deeper (0.6 mm supracrestal). The edge of the implant must be easily accessible in order to correctly tighten the abutment after the initial healing phase. Very good primary stability is important. Use a healing cap to cover the implant after the placement and close the gums. A healing abutment can be used directly in exceptional cases. The minimum required healing period is 3 months for the lower jaw and 6 months for the upper jaw.

Do not over-tighten We recommend a screw-in torque of 20–30 Ncm. The maximum torque for NP Ø 3.5 mm implants is 35 Ncm. For RP Ø 4.2 mm and WP Ø 5.5 mm implants, the maximum torque is 45 Ncm. Never exceed this torque. The required torque is always less than the maximum torque, depending on the bone quality (soft bone → less torque) and implant length (short implants → less torque).

5 Prosthetic restoration

A range of standard and NobelPearl Docklocs® abutments for removable prostheses is available for prosthetic restorations. Find out more on page 26 onwards (Restorative procedure).

Distances at bone level

Distance to adjacent tooth at bone level

A minimum distance of **1.5 mm** between the implant shoulder and the adjacent tooth is required at bone level (mesial and distal).

Distance to adjacent implant at bone level

A minimum distance of **3 mm** between two adjacent implant shoulders (NP/RP/WP) (mesiodistal) is required.

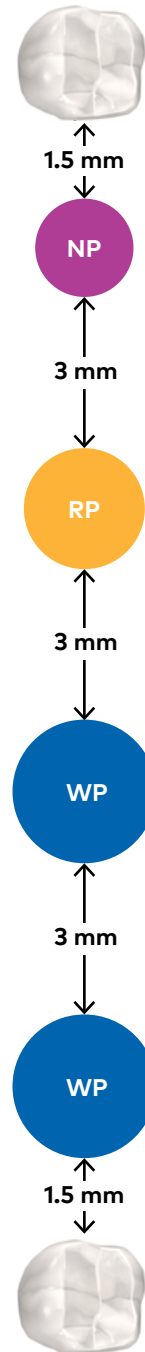

Depth measurement



Diameter

The diameter is indicated on each tool by a color code.



Example of implant

NobelPearl™ Tapered RP 4.2x8mm, 1.6 mm supracrestal

Caution The drilling depth is up to 1 mm deeper than the corresponding implant.

Sterilization before surgery

Surgical preparation includes steam sterilization of the surgical tray (surgical instruments) at 132 °C / 270 °F or 134 °C / 274 °F / for: 18 minutes

Important If the drills and instruments are used more than once, place them in the saline solution during the treatment.

Drill Sequence

Planning the insertion depth with the drill stop

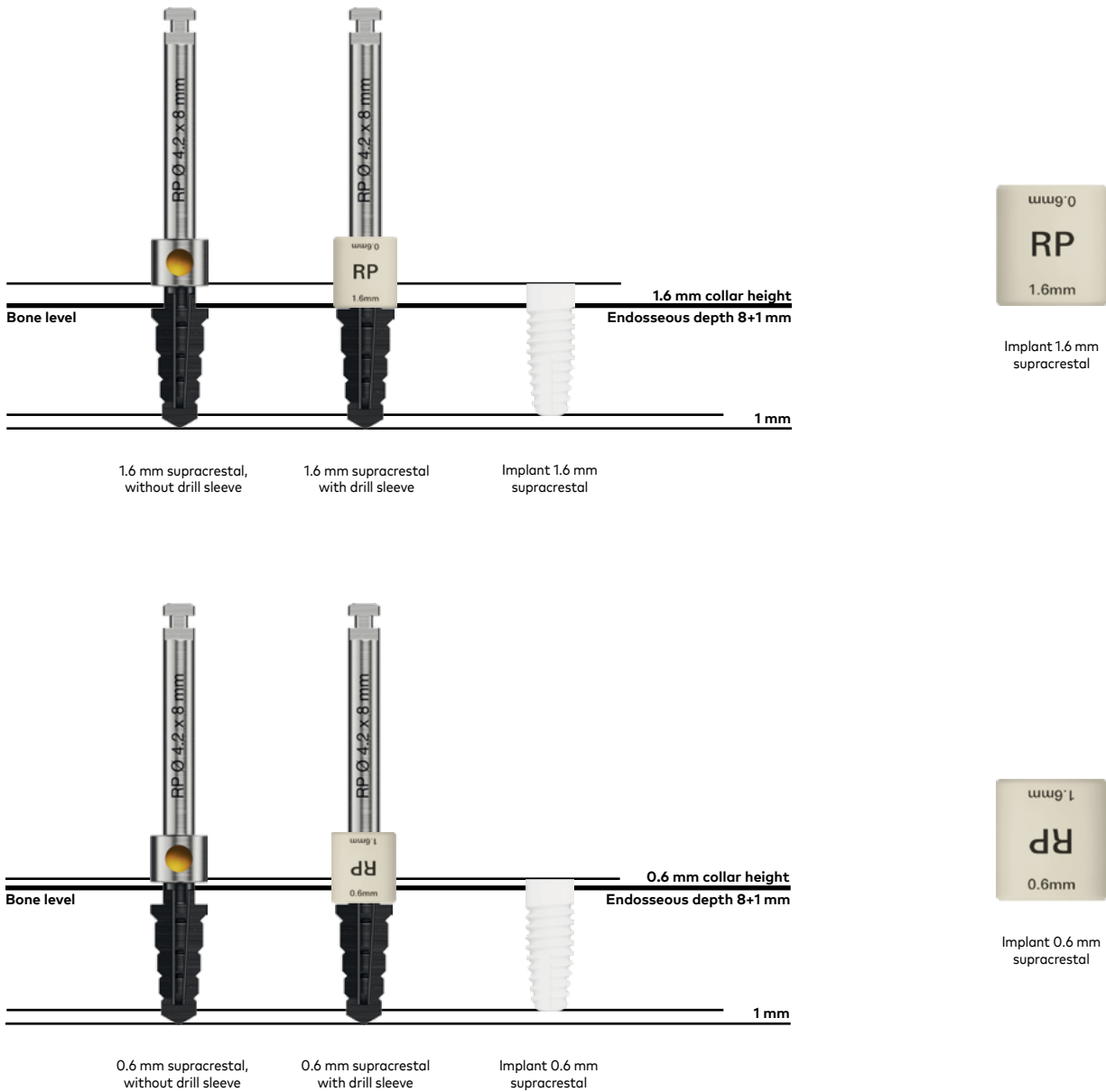

Drill stop

The NobelPearl™ Tapered Drill Stop allows the drilling depth to be precisely controlled. The NobelPearl™ Tapered Drill Stop is placed on the drill sleeve. It allows you to insert the implant 1.6 mm or 0.6 mm supracrestal.

Drill protocol NP 3.5 mm (1.6 mm supracrestal)

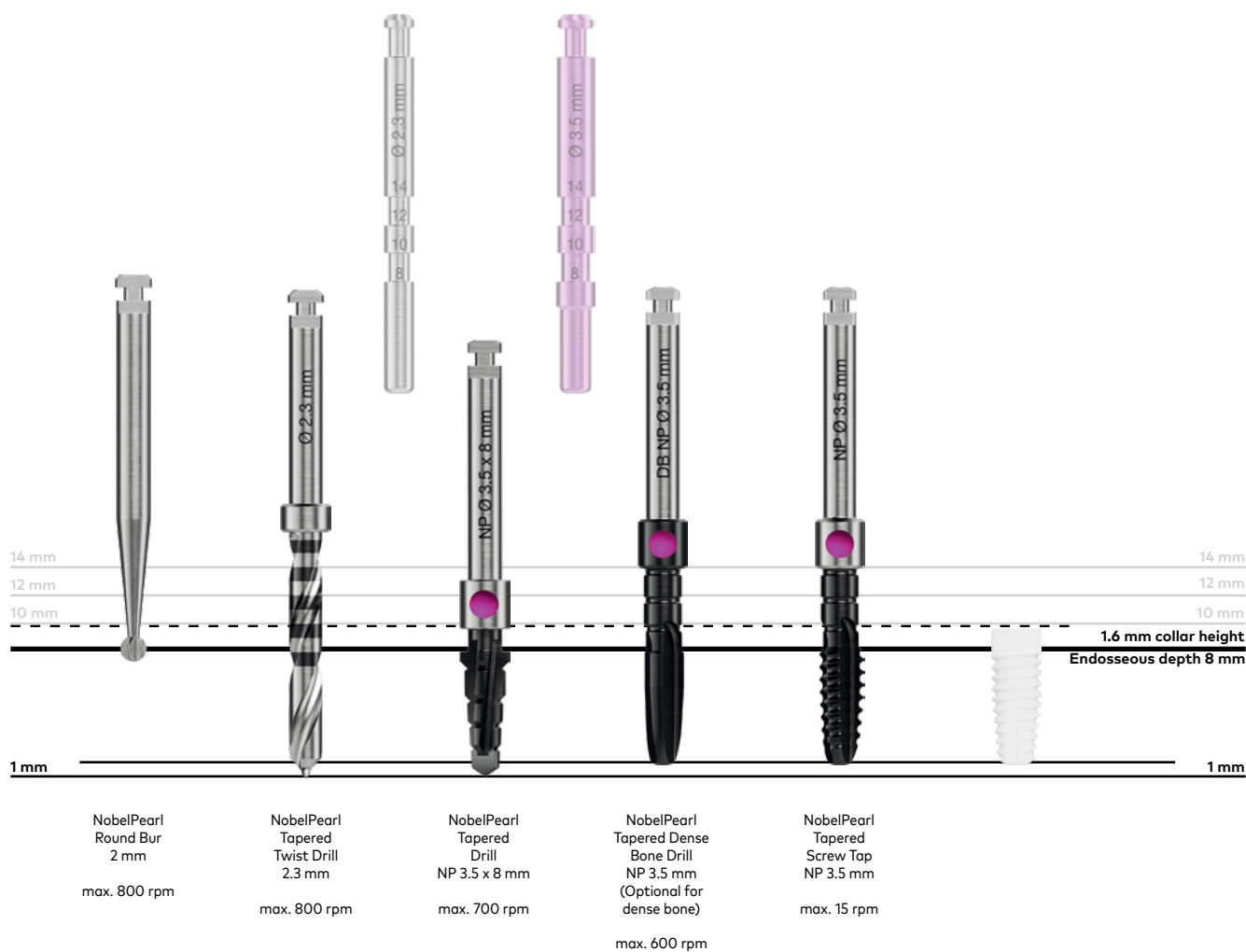

Example of implant

NobelPearl™ Tapered NP 3.5x8mm

Information The NP platform implants may only be used in the anterior teeth in the lower jaw and lateral incisor in the upper jaw. (See indications in the Instructions For Use)

Note Optionally, the implant can also be positioned 0.6 mm supracrestal (instead of 1.6 mm). Drill 1 mm deeper in this case. The NobelPearl™ Tapered Cortical Drill NP is also required.

Important With NobelPearl™ Tapered NP implants, do not exceed a torque of 35 Ncm.

Caution Always use the NobelPearl™ Tapered Screw Tap NP to full depth.

Drill protocol NP 3.5 mm (0.6 mm supracrestal)

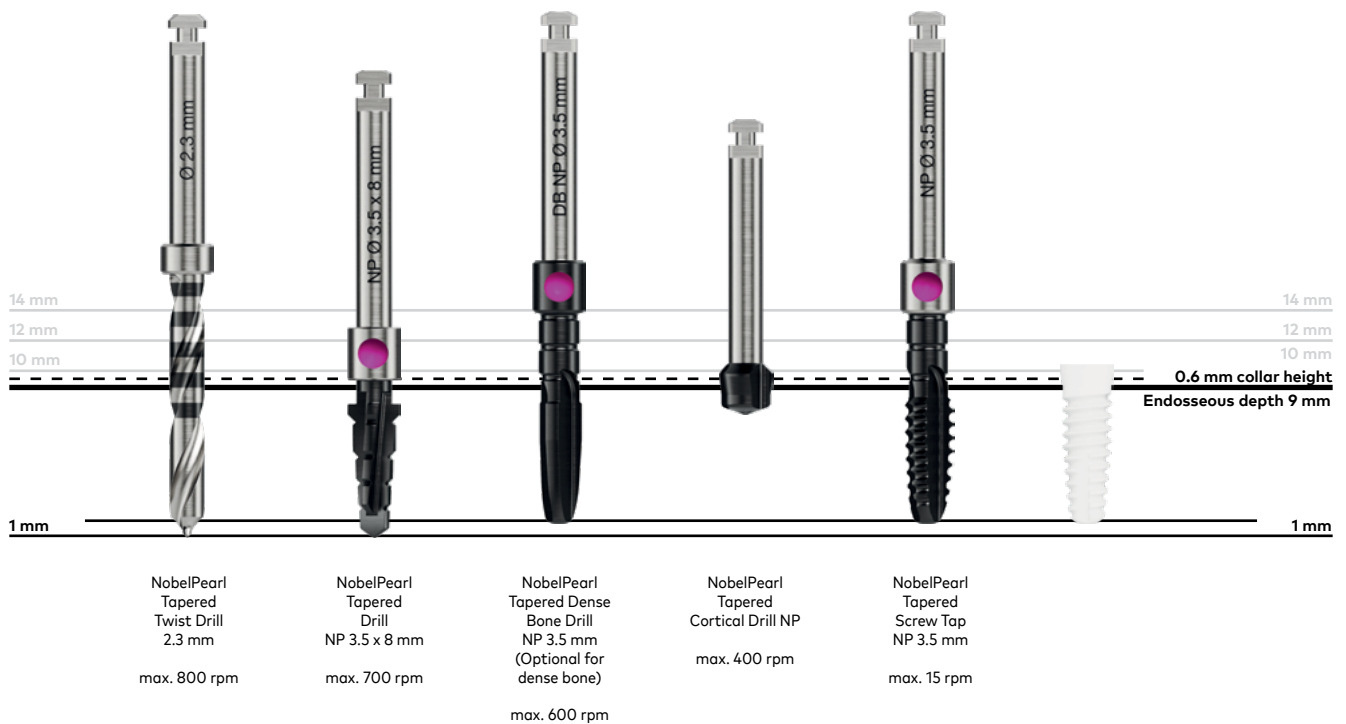

Example of implant

NobelPearl™ Tapered NP 3.5x8mm

Information The NP platform implants may only be used in the anterior teeth in the lower jaw and lateral incisor in the upper jaw. (See indications in the Instructions For Use)

Note If the implant is placed 0.6 mm supracrestal, the drill and screw tap must be inserted 1 mm deeper. A cortical drill is also required.

Important With NobelPearl™ Tapered NP implants, do not exceed a torque of 35 Ncm.

Caution Always use the NobelPearl™ Tapered Screw Tap NP to full depth.

Drill protocol RP 4.2 mm (1.6 mm supracrestal)

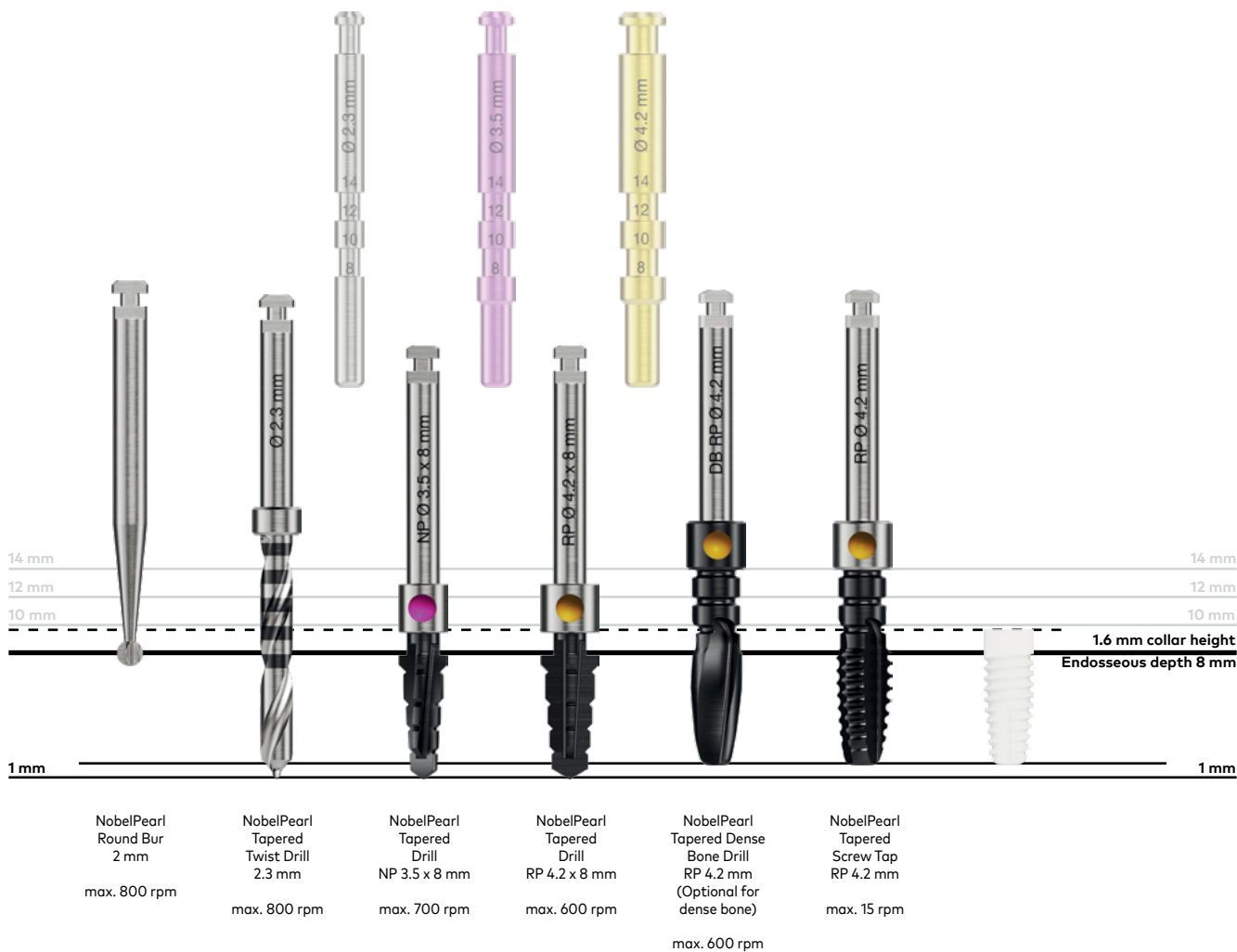

Example of implant

NobelPearl™ Tapered RP 4.2x8mm

Note Optionally, the implant can also be positioned 0.6 mm supracrestal (instead of 1.6 mm). The drill and screw tap must be inserted 1 mm deeper in this case.

Important With NobelPearl™ Tapered RP implants, do not exceed a torque of 45 Ncm.

Caution Always use the NobelPearl™ Tapered Screw Tap RP to full depth.

Drill protocol RP 4.2 mm (0.6 mm supracrestal)

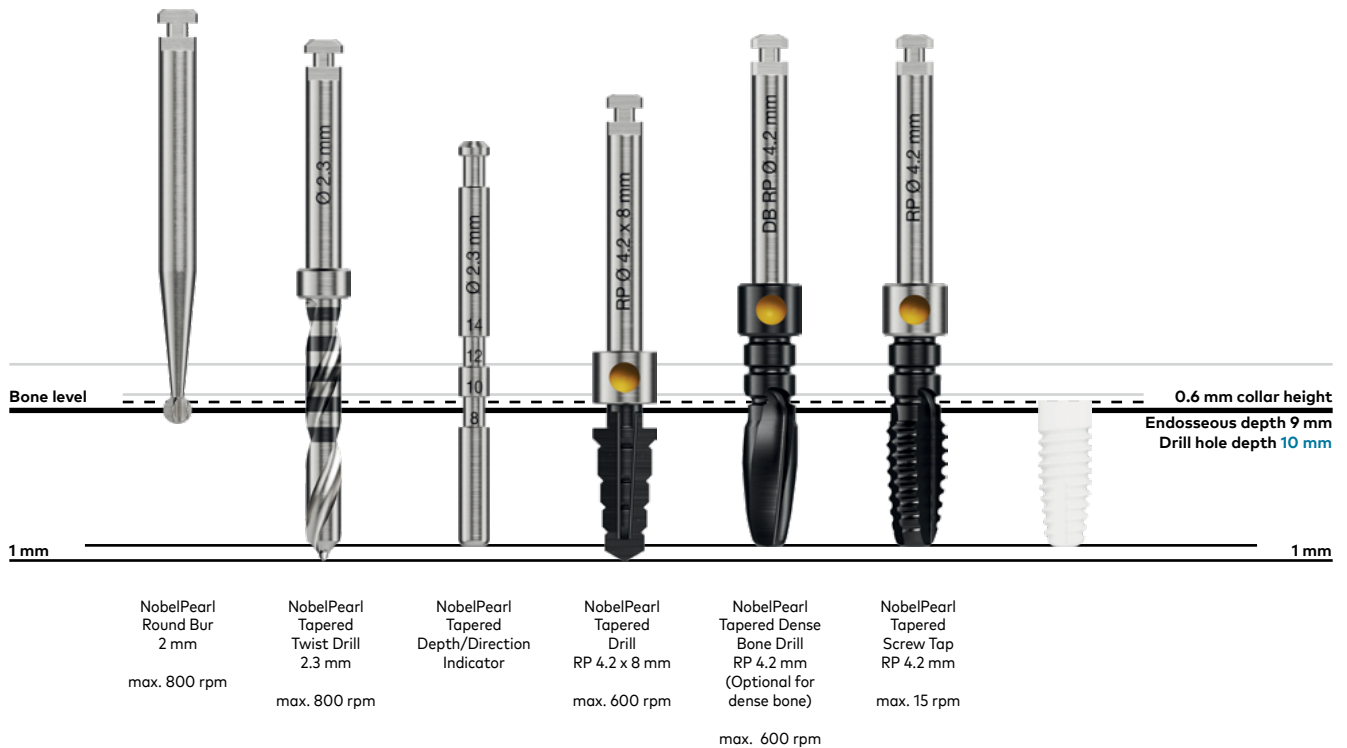

Example of implant

NobelPearl™ Tapered RP 4.2x8mm

Important The effective drilling depth is up to 2 mm longer than the defined implant length.

Platform	Selected implant length	Pilot Drill drill hole depth	NobelPearl Tapered Drill	NobelPearl Tapered Dense Bone Drill	NobelPearl Tapered Screw Tap	Screw-in depth	Effective hole depth
RP 4.2	8 mm	9 mm	Up to sleeve	9 mm	9 mm	0.6 mm Supracrestal	10 mm
	10 mm	11 mm	Up to sleeve	11 mm	11 mm	0.6 mm Supracrestal	12 mm
	12 mm	13 mm	Up to sleeve	13 mm	13 mm	0.6 mm Supracrestal	14 mm
	14 mm	*	*	*	*	*	*

*For a length of 14 mm, we recommend that the implant is not placed 0.6 mm supracrestal.

Drill protocol WP 5.5 mm (1.6 mm supracrestal)

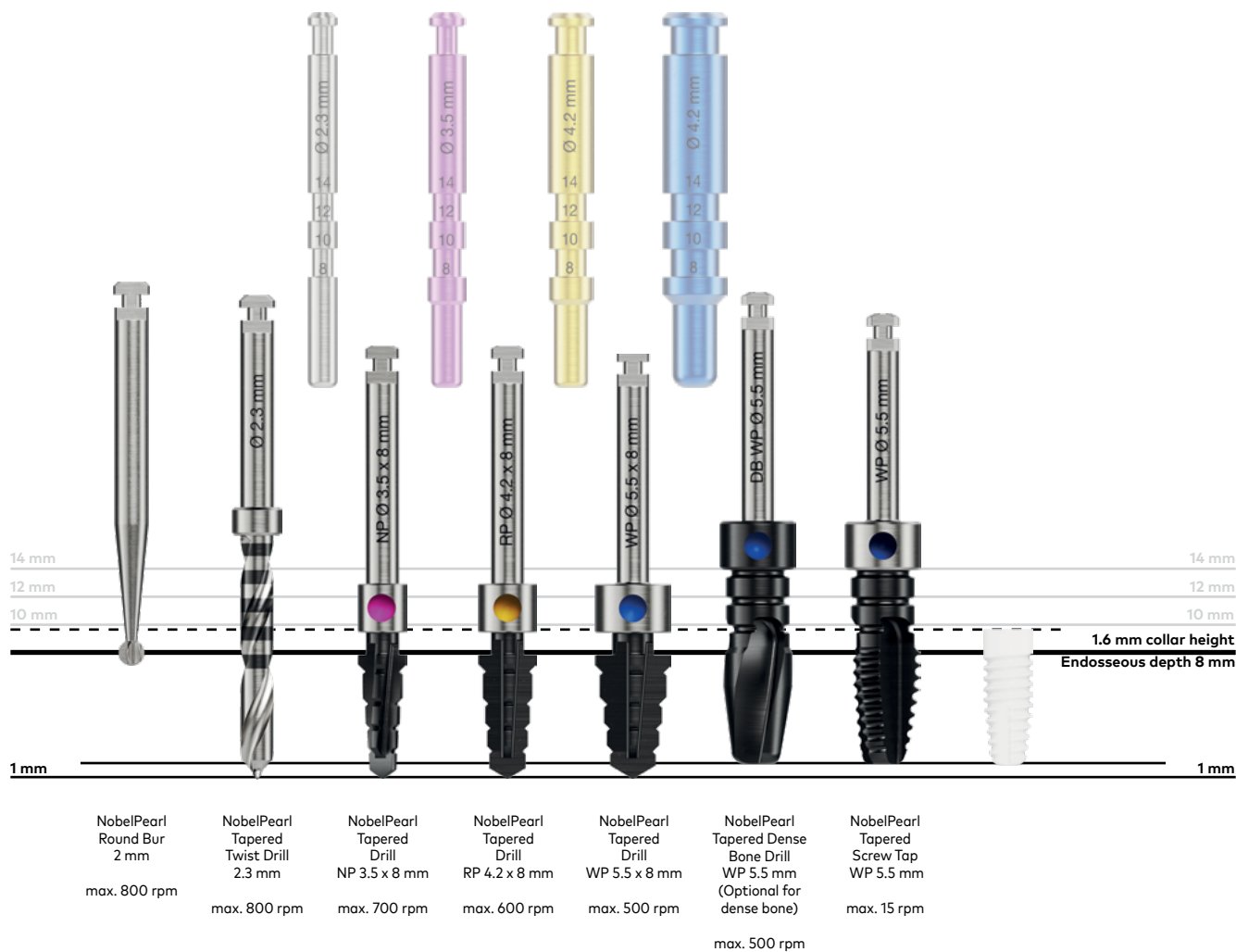

Example of implant

NobelPearl™ Tapered WP 5.5x8mm

Note Optionally, the implant can also be positioned 0.6 mm supracrestal (instead of 1.6 mm). The drill and screw tap must be inserted 1 mm deeper in this case.

Important With NobelPearl™ Tapered WP implants, do not exceed a torque of 45 Ncm.

Caution Always use the NobelPearl™ Tapered Screw Tap WP to full depth.

Implant insertion

Handling

1 Contents

Box contents: Implant in spherical packaging with corresponding cover screw.



Important Check the required implant dimensions before opening the package.

2 Open Sphere

Open the sphere by twisting.

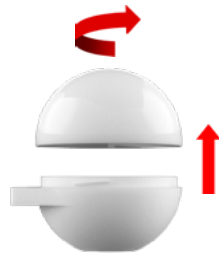

3 Remove

Remove the sterile secondary blisters (low microbial contamination) and patient labels from the sphere.



4 Open blister

Break the seal shortly before use (interior is sterile).



Important The cover screw corresponding to the implant is also included in the sterile secondary blister in the designated cavity.

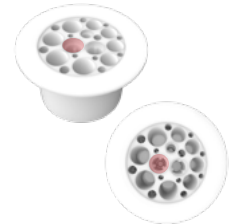

5 Pick up implant

Pick up the implant using the NobelPearl™ Implant Driver Inter-X (insert in the NobelPearl™ Manual Torque Wrench Adapter; snap in the square socket).



Insert

1 Screw in

Open the implant package and pick up the implant using the NobelPearl Implant Driver Inter-X. Place the implant into the osteotomy. The implants are ideally installed with low speed (maximum 15 rpm).

Important Never use the NobelPearl Rescue Driver Inter-X for insertion.

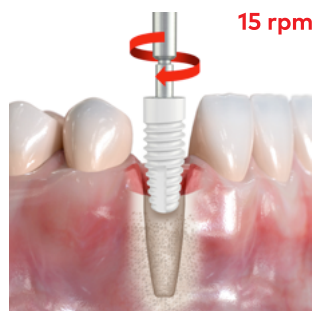

2 Tighten

Tighten the implant with the NobelPearl™ Manual Torque Wrench using 20–30 Ncm insertion torque. The maximum torque for RP and WP implants is **45 Ncm**. The maximum torque for all NP implants is **35 Ncm**. Do not exceed this torque. The NobelPearl Implant Driver Inter-X has a predetermined fracture point of approximately 50 Ncm. Maximum speed: **15 rpm**



Important Due to the conical design, torque is only exerted in the last two rotations.

3 Positioning

The arrows "►" show the possible positions of the angled abutment. Take this into account when inserting the implant.



Cover Screw

4 Cover Screw

Connect and tighten the NobelPearl™ Cover Screw Inter-X to the implant using the NobelPearl™ Implant Driver Inter-X or NobelPearl™ Screwdriver. Do not exceed the maximum torque of 5 Ncm.

Note NobelPearl Tapered implants are intended for delayed loading.

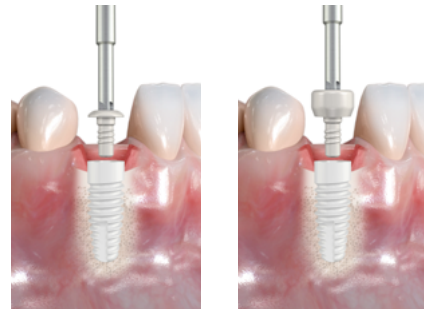

5a Version 1

Closed healing (recommended).



5b Version 2

Open healing; note closely adjacent gingiva.



Do not over-tighten

The maximum torque for all NP implants is **35 Ncm**. The maximum torque for RP and WP implants is **45 Ncm**. Never exceed this torque. The NobelPearl™ Implant Driver Inter-X has a predetermined breaking point of approximately 50 Ncm. Maximum speed: **15 rpm**.



Restorative procedure

Soft tissue management	26
Digital impression taking	28
Conventional impression taking	30
Prosthetic workflow	34
Screw-retained prosthetic restoration	35
Cement-retained prosthetic restoration	39
Platform switching	40
Screw-retained prosthetic restoration CAD/CAM	41
NobelPearl Docklocs® Abutments	44
Technical data for NobelPearl abutments	46
Grinding Standard Abutments	48
Technical data for NobelPearl screws	50

Soft tissue management

Healing abutment

1 Insert

Connect and tighten the NobelPearl™ Healing Abutment Inter X to the implant using the NobelPearl™ Screwdriver. Do not exceed the maximum torque of 5 Ncm.



Do not over-tighten Force does not need to be applied to insert the healing abutment. Carefully screw into the full depth.



2 Remove

To remove the healing abutment, insert the NobelPearl™ Screwdriver and turn counterclockwise.



Temporary restoration

1 Position

Position the NobelPearl™ Temporary Abutment Inter-X and tighten the NobelPearl™ Temporary Clinical Screw Inter-X with the NobelPearl™ Screwdriver (max. 15 Ncm).

Important The use of NobelPearl™ Temporary Abutment Inter-X is limited to 180 days.

General information Bear in mind that polymer prosthetic components have a different feel than metal to the user. Familiarize yourself with this beforehand.



2 Process

If necessary, work on the provisional extraorally and provide it with a provisional crown.

Processing the provisional restoration It is preferable to machine the polymer with fine-grain diamond-coated instruments at a high speed. This is done extraorally with slight pressure and effective cooling.



Digital impression taking

Intraoral scan

In the surgery

1 Positioning

Thoroughly clean the implant connection. Place the corresponding NobelPearl™ Position Locator Inter-X on the implant and ensure that the surface is clearly visible to the scanner during positioning.



2 Screw tight

Tighten the NobelPearl™ Position Locator Inter-X with the corresponding screw (**max. 5 Ncm**) and ensure it is firmly in place.



3 Taking an impression

Perform the scanning procedure according to the instructions of the system used. Send digital scan data to the laboratory to create the 3D print model with associated analogue cavity.



Information Alternatively, a master model can also be digitized in a 3D laboratory scanner for further processing.

Information Method suitable for common CAD/CAM systems.

In the laboratory

4 Connecting

Screw in the NobelPearl™ IOS Implant Replica Placer (insertion instrument) by hand in a clockwise direction.

Important Check the analogue cavity in the print model for structural defects and residues.



5 Fitting

Insert and center the NobelPearl™ IOS Implant Replica Inter-X into the cavity. Then press the NobelPearl™ IOS Implant Replica Inter-X down with sufficient pressure until it clicks into place. The basally visible surface should be flush with the print model. Check NobelPearl™ IOS Implant Replica Inter-X for tight fit.

Important Repeated removal and insertion of the NobelPearl™ IOS Implant Replica Inter-X in the same model may cause wear to the snap-in function.

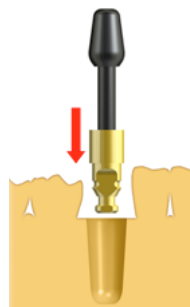

6 Restoration

The individual secondary part for occlusal screwed restorations (from page 36) is available for the digital workflow. Digital scan data can be processed directly in exocad and 3Shape software (complete integration).

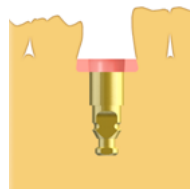

Conventional impression taking

Open tray

In the surgery

1 Positioning

Place the locking pin with the NobelPearl™ Impression Coping Open Tray Inter-X on the implant shoulder under slight pressure while turning until it snaps into the socket, rests securely on the implant shoulder, and can no longer be rotated.



2 Screw tight

Secure the NobelPearl™ Impression Coping Open Tray Inter-X with one hand. Tighten the locking pin clockwise by hand, and check the position for a firm fit. In case of doubt, take an X-ray.



3 Taking an impression

Create the impression with an open tray. Unscrew and remove the locking pin. Remove the impression and send with the locking pin to the dental technician.

Important The NobelPearl™ Impression Coping Open Tray Inter-X must be snapped into the inner edge and fit securely. To check, apply a slight counter-movement.

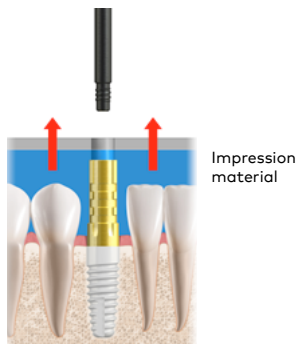

Information The four **retaining elements** of the implant must be correctly aligned when selecting an **angled abutment** (User Instructions Surgery, page 22, fig. 3), otherwise we recommend using a **customized abutment** instead (page 42).

In the laboratory

4 Connecting

Position the NobelPearl™ Impression Coping Open Tray Inter-X on the replica shoulder under slight pressure while twisting until it snaps into the socket of the NobelPearl™ IOS Implant Replica Inter-X, rests securely on the shoulder and can no longer be rotated. Tighten the locking pin clockwise by hand.

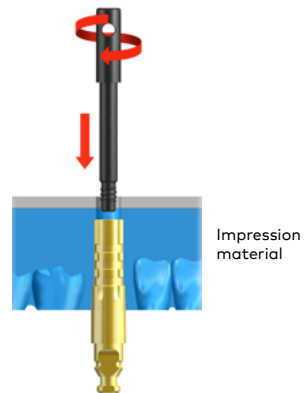

5 Creating model

Check that the NobelPearl™ Impression Coping Open Tray Inter-X with the screw-fitted NobelPearl™ IOS Implant Replica Inter-X is securely seated. Create master model. Remove the locking pin before removing the impression.



6 Restoration

Select an abutment based on the prosthetic requirements and the preferred surgical method. Straight and angled abutments and customized abutments are available, along with NobelPearl Docklocs® Abutments (from page 46).

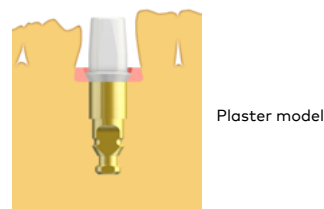

Closed tray

In the surgery

1 Positioning

Place the NobelPearl™ Impression Coping Closed Tray Inter-X on the implant shoulder under slight pressure while turning until it snaps into the socket, rests securely on the implant shoulder, and can no longer be rotated.



2 Tighten

Tighten the locking pin clockwise by hand, and check the position for a firm fit.



3 Taking an impression

Take an impression with a closed tray and remove. Unscrew the locking pin, remove the NobelPearl™ Impression Coping Closed Tray Inter-X from the implant and send to the dental technician with the impression.



Impression material

Important The NobelPearl™ Impression Coping Closed Tray Inter-X must be snapped into the inner edge and fit securely. To check, apply a slight counter-movement.

Caution Closed impression taking is not recommended for the front section of the maxilla or in the case of angulation greater than 15°.

In the laboratory

4 Connecting

Position the transfer sleeve on the NobelPearl™ IOS Implant Replica Inter-X shoulder under slight pressure while twisting until it snaps into the socket of the digital NobelPearl™ IOS Implant Replica Inter-X, rests securely on the shoulder and can no longer be rotated. Tighten the locking pin clockwise by hand.

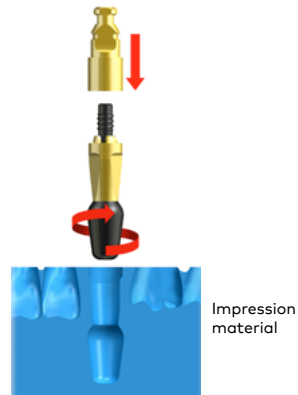

5 Repositioning and creating model

Reposition the NobelPearl™ Impression Coping Closed Tray Inter-X with the screw-fitted digital NobelPearl™ IOS Implant Replica Inter-X and check that it is securely seated. Create master model.

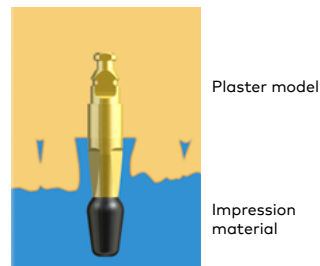

6 Restoration

Select an abutment based on the prosthetic requirements and the appropriate surgical method. Straight and angled abutments, CAD/CAM and customized abutments are available, along with NobelPearl Docklocs® Abutments (from page 46).

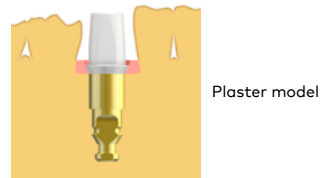

Prosthetic workflow

1 Preparation phase

Prosthetic restoration is governed by the overall approach for achieving the best possible results. Integral functionality, esthetics and patient comfort are the primary considerations. A detailed dental analysis (including X-rays) taking into account the patient's medical history is the foundation for this. Create the treatment plan based on the main considerations.

2 Soft-tissue management

A "pink" appearance reflects healthy gums. It is essential to treat any gum disorders in advance. Soft tissue grows well around zirconia, which is of great relevance, especially in the anterior region. A natural emergence profile is individually created using a healing abutment or a provisional, and the "black triangle" is a thing of the past.

NP 3.5 The prosthetic components marked with magenta color-coding are for the NP platform (3.5 mm implant).

RP 4.2 The prosthetic components marked with yellow color-coding are for the RP platform (4.2 mm implant).

WP 5.5 The prosthetic components marked with blue color-coding are for the WP platform (5.5 mm implant).

3 Abutment/implant connection

There are two basic pathways to metal-free, esthetically and biologically flawless restoration:

- Screw-retained prosthetic restoration (page 34)
- Cemented prosthetic restoration (page 38)

The range of metal-free prosthetics is extensive and satisfies the stringent requirements with regards to esthetics and functionality. The NobelPearl implant with its various abutments is ideal for nearly every situation.

4 Workflow

The NobelPearl implant system seamlessly integrates with conventional procedure using manual, direct and indirect impressions.



Note The exceptions are the screws. Definitive clinical screw, temporary clinical screw, lab screw and position locator screw. Please note the information on pages 48-50.

Screw-retained prosthetic restoration

Fabricating supraconstructions in the laboratory

Everything you need for the laboratory at a glance

- Every abutment is supplied with the corresponding NobelPearl™ Definitive Clinical Screw Inter-X.
- Every NobelPearl™ Definitive Clinical Screw Inter-X screw may only be tightened once up to the maximum torque.
- The torque for the NobelPearl™ Definitive Clinical Screw Inter-X is always **min. 20 Ncm / max. 25 Ncm!**
- For work in the laboratory, we offer the NobelPearl™ Lab Screw Inter-X that may not be tightened more than **5 Ncm**.
- Adapt your approach to the anatomical situation and do not use over-dimensioned crowns or connections to natural teeth (hybrid restoration).
- Do not use "floating crown attachments" with an abutment.
- When grinding the abutment, an additional NobelPearl™ IOS Implant Replica Inter-X can be used as a holder. Counterpressure with the fingers reduces vibration.

Tip Use an individual positioning wrench for angled abutments or complex restorations.

Important It is essential to consider the minimum layer thickness according to the manufacturer's instructions for the specific crown material.

1 Select the suitable abutment.

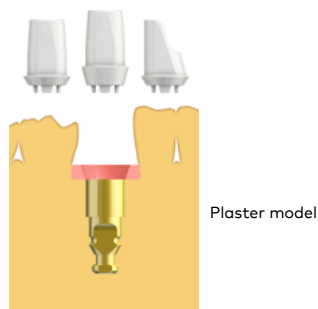

2 If necessary, individually machine the abutment. Only process the abutment under sufficient, continuous cooling with slight pressure. Local overheating causes micro-fissures and destruction of the abutment.



Important Please note the information on machining abutments on page 47!

3a All abutments are approved for the following: Adhesion, milling and pressing. You can choose a monolithic crown (C1) or a full-ceramic crown on a zirconia cap (C2).



3b Monolithic crowns made of various optimized polymers or zirconia.

3c All-ceramic crowns made of layered or pressed ceramic on a zirconia cap.



Optimal design of screw channel

Restoration with placeholders

When using placeholders, make sure that the screw channel diameter allows the NobelPearl™ Definitive Clinical Screw Inter-X to be inserted into and removed from the abutment and crown at any time, even when the crown is already tightly cemented to the abutment.

You can make your own positioning aids/placeholders:
NP/RP/WP platform: > 2.8 mm



The diameter of the screw channel for the NobelPearl™ Definitive Clinical Screw Inter-X **must be > 2.8 mm.**

Screw channel with a reduced diameter

You can also use screw channels with a reduced diameter instead of placeholders. With this, the screw channel diameter can be reduced to **> 2.2 mm**. The NobelPearl™ Screwdriver can be used as a placeholder.

Important

- When a screw channel with a reduced diameter is planned, the NobelPearl™ Definitive Clinical Screw Inter-X must be inserted into the abutment in the laboratory before the crown is secured onto the abutment.
- The NobelPearl™ Definitive Clinical Screw Inter-X cannot be screwed in or out after the crown has been cemented.
- When cementing the crown, excess cement must not enter the screw channel of an inserted screw (insert cotton wad or a similar placeholder that can be removed from the screw channel).
- If the abutment is shortened, make sure that the NobelPearl™ Definitive Clinical Screw Inter-X has sufficient vertical space to be screwed in and out.



The diameter of the screw channel for the reduced-diameter version **must be > 2.2 mm.**

Caution When sealing the screw channel, do not use any gels or liquids containing chlorine.

Insertion of screw-retained, finalized crown in the patient's mouth

1a Insertion of screw

The cap can be veneered by pressing or layering. Select the diameter of the screw channel for later screwing depending on the procedure:

- NP/RP/WP abutments: > 2.8 mm
- **Reduced diameter: > 2.2 mm***

Important *When using reduced-diameter screws, the screw must be inserted into the abutment before the crown is cemented onto the abutment. Please note the information on [page 36](#).

Do not overtighten The unique torque for the NobelPearl™ Definitive Clinical Screw Inter-X for all platforms is **(NP/RP/WP): min. 20 Ncm / max. 25 Ncm.**

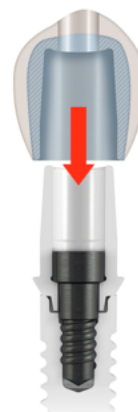

1b Placement of finalized crown

Place the abutment with the cemented crown on the implant. Apply slight pressure to fit the abutment/crown until it snaps into place in the correct position. Hold the abutment/crown and tighten the screw in the screw channel by applying pressure from the occlusal direction. **Use the NobelPearl™ Screwdriver and the NobelPearl™ Manual Torque Wrench (NP/RP/WP: min. 20 Ncm / max. 25 Ncm).** Use a probe and/or X-ray to check if the abutment is correctly seated.



Cement-retained prosthetic restoration

Cementing the crown in the patient's mouth

Note If a screw channel is not possible or required, the crown can be produced in the laboratory without a screw channel.

Do not overtighten The unique torque for the NobelPearl™ Definitive Clinical Screw Inter-X for all platforms is **(NP/RP/WP): min. 20 Ncm / max. 25 Ncm.**

1 Insertion of screw

The NobelPearl™ Definitive Clinical Screw Inter-X is picked up with the NobelPearl™ Screwdriver and inserted into the abutment. The abutment can now be transferred onto the implant with the NobelPearl™ Screwdriver.

Note Hold the abutment and screw tight > No locking! Before tightening the screw, press it downward. Use the NobelPearl™ Screwdriver and the NobelPearl™ Manual Torque Wrench to tighten the screw. **(NP/RP/WP: min. 20 Ncm / max. 25 Ncm).** Use a probe and/or X-ray to check if the abutment is correctly seated.

Note An individual positioning wrench may need to be made.

2 Placement of finalized crown

The cap can be veneered by pressing or layering. Cement the finished crown onto the tightly screwed abutment, and remove any excess cement.

Note There is a specific NobelPearl Screw for each abutment. Please refer to pages 46-47 for technical data on NobelPearl screws.



Platform switching

Platform Switching options

To prevent potential crestal bone loss or to increase the soft tissue volume around the implant platform, the excellent prosthetic flexibility of the NobelPearl system allows platform switching with two options available.

It is possible to place an NP abutment

**NP
3.5**

**NobelPearl
NP Abutments**
Straight 1 mm, Straight 2 mm and
Angular 1 mm



**NobelPearl
NP Implants**

It is possible to place an RP abutment

**RP
4.2**

**NobelPearl
RP Abutments**
Straight 1 mm, Straight 2 mm and
Angular 1 mm



**NobelPearl
RP Implants**

**RP
4.2**

Examples
NP Abutment Straight 1 mm
RP Implant 10 mm

**WP
5.5**

Examples
RP Abutment Straight 1 mm
WP Implant 10 mm

Caution There is no option for platform switching for NobelPearl WP implants with NobelPearl NP abutments.

Screw-retained prosthetic restoration CAD/CAM

NobelPearl Ceramic Base for customized abutments

NobelPearl™ Ceramic Base Engaging Inter-X for crowns. The four interlocks secure the position on the implant.

NobelPearl™ Ceramic Base Non-Engaging Inter-X for bridges and bars. No protection against rotation

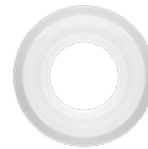
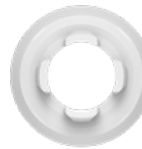

NobelPearl™ Ceramic Base Engaging Inter-X

NobelPearl™ Ceramic Base Non-Engaging Inter-X

NobelPearl™ Position Locator Inter-X

- Stable polymer for multiple use in the laboratory
- Position locator tightening torque: **max. 5 Ncm**

Note Please do not grind the NobelPearl™ Position Locator Inter-X. There is a possibility that the system could no longer recognize it.



NobelPearl™ Position Locator Inter-X

Work processes

The NobelPearl Ceramic Base Abutment allows you to work using your preferred work process.

Conventional work process

- Creating wax-up for molded or milled restorations.

Digital work process (digital design in DTX, exocad or 3Shape software)

- Modified abutment → scanning without Scanbody and designing in the software.
- Non-modified abutment → scanning in Scanbody and designing in the software.

Production

The cap or crown will be milled in your laboratory, in the milling center of your choice or chairside.

Leading software

The NobelPearl Ceramic Base Abutments are integrated in the market-leading systems: DTX, exocad and 3Shape.

exocad: The library will be updated automatically to include the NobelPearl Ceramic Base and Abutments.

Exception: Systems from Zirkozahn and Amann Girschbach require manual importation of the file.

3Shape: Please download the files from our website and import them into your system.



Information You can find more information on our website nobelbiocare.com/nobelpearl

Processing information & material

Processing information

- Conical part can be **shortened by max 3 mm for the NobelPearl Ceramic Base.**
- Only machine under good, continuous cooling with slight pressure
- Use high speed (turbines) and fine grain size (red-ring diamond, smaller than 50 µm).
Important: Please note the information on machining abutments on page 47!
- Final tightening torque of abutment with Vicarbo® screw: NP, RP and WP: **min. 20 Ncm / max. 25 Ncm** (in lab, use lab screws: **max. 5 Ncm**)
- CTE for ZrO₂ ATZ: $9 \times 10^{-6}/K$
- Adhesion using commercially-available adhesives

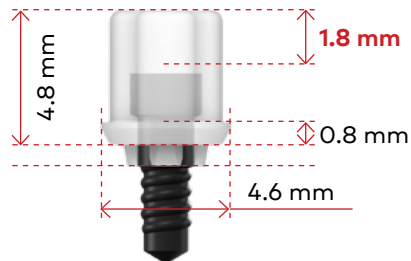

Example of NobelPearl
301264

Material

- NobelPearl Ceramic Base Abutments: zirconia, ATZ
- NobelPearl™ Position Locator Inter-X: PEEK
- NobelPearl™ Definitive Clinical Screw Inter-X: Vicarbo® (carbon-fiber reinforced PEEK)

NobelPearl™ Docklocs® Abutments

NobelPearl™ Docklocs® is a pre-finished connection system to secure removable restorations based on a snap connection.

NobelPearl™ Docklocs® Abutments are available in three heights (2 mm/3 mm/4 mm) and fit on all platforms (NP/RP/WP).

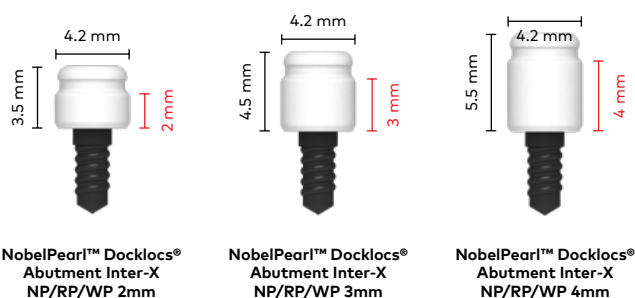

Divergences

The NobelPearl™ Docklocs® system offers the option of integrating a dental prosthesis for implantation that diverges by up to 20°. This means that deviations between two implants of **up to 40°** can be corrected.

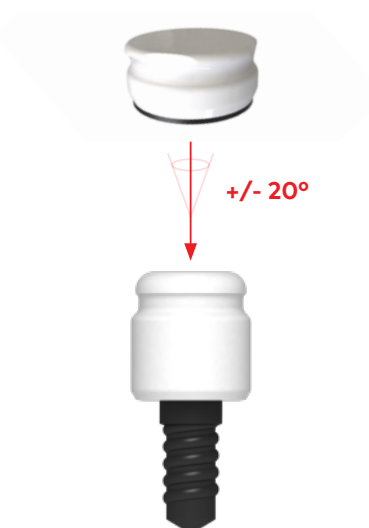

1 Insert the NobelPearl™ Docklocs® Abutment

Ensure that the implant shoulder is not covered by hard or soft tissue. Screw the NobelPearl™ Docklocs® Abutment with the NobelPearl™ Docklocs® Latch Handpiece Driver into the implant and tighten by hand. Tighten the abutment with the NobelPearl™ Manual Torque Wrench, the NobelPearl™ Manual Torque Wrench Adapter adapter and the NobelPearl™ Docklocs® Insertion Instrument to **15 Ncm**.

Note Horizontal alignment of all NobelPearl™ Docklocs® Abutments makes the insertion of the prosthesis easier for the patient.



NobelPearl™ Docklocs® Latch Handpiece Driver

Do not overtighten

The unique torque for the NobelPearl™ Definitive Clinical Screw Inter-X of the NobelPearl™ Docklocs® Abutments for all platforms (NP/RP/WP) is: **max. 15 Ncm**.

Docklocs® is a registered trademark of MEDEALIS GmbH, DE.

For the further steps to create the prosthesis the products from the LOCATOR® abutment portfolio can be used. There are metal-free Docklocs® housings available.

Technical data for NobelPearl abutments

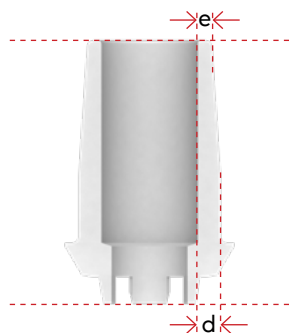
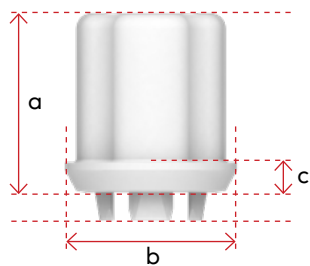
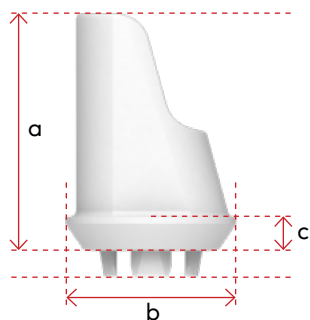
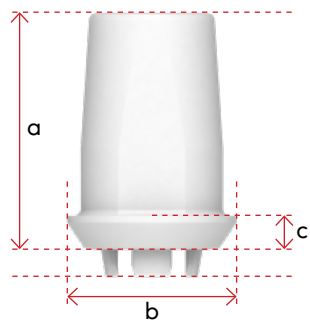

NP
3.5

		a	b	c	d	e
300663	NobelPearl™ Abutment Straight Inter-X NP 1mm	7.0	4.6	1.0		
300666	NobelPearl™ Abutment Straight Inter-X NP 2mm	8.0	4.6	2.0	0.7	0.6
300669	NobelPearl™ 15° Abutment Inter-X NP 1mm	7.0	4.6	1.0		
301263	NobelPearl™ Ceramic Base Engaging Inter-X NP	4.8	4.6	0.8	0.4	—
301285	NobelPearl™ Ceramic Base Non-Engaging Inter-X NP	4.8	4.6	0.8		

RP
4.2

		a	b	c	d	e
300664	NobelPearl™ Abutment Straight Inter-X RP 1mm	7.0	5.0	1.0		
300667	NobelPearl™ Abutment Straight Inter-X RP 2mm	8.0	5.0	2.0	0.7	0.6
300670	NobelPearl™ 15° Abutment Inter-X RP 1mm	7.0	5.0	1.0		
301264	NobelPearl™ Ceramic Base Engaging Inter-X RP	4.8	4.6	0.8	0.4	—
301286	NobelPearl™ Ceramic Base Non-Engaging Inter-X RP	4.8	4.6	0.8		

WP
5.5

		a	b	c	d	e
300665	NobelPearl™ Abutment Straight Inter-X WP 1mm	7.0	6.0	1.0		
300668	NobelPearl™ Abutment Straight Inter-X WP 2mm	8.0	6.0	2.0	0.7	0.6
300671	NobelPearl™ 15° Abutment Inter-X WP 1mm	7.0	6.0	1.0		
301265	NobelPearl™ Ceramic Base Engaging Inter-X WP	4.8	5.6	0.8	0.4	—
301287	NobelPearl™ Ceramic Base Non-Engaging Inter-X WP	4.8	5.6	0.8		

Grinding Standard Abutments

Do not overtighten

The unique torque for the NobelPearl™ Definitive Clinical Screw Inter-X for all platforms is
(NP/RP/WP): min. 20 Ncm / max. 25 Ncm.

Example of abutment

NobelPearl Abutment Straight RP 1 mm

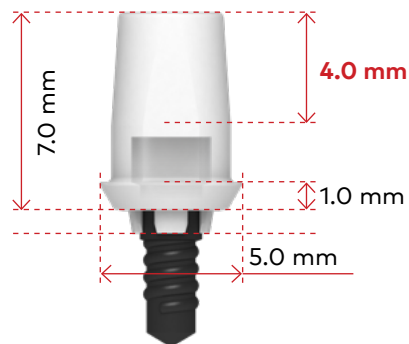

Example of abutment
NobelPearl Abutment Straight RP 1 mm

Material

ZrO₂ ATZ-HIP

Composition:

- ZrO₂: 76%
- Al₂O₃: 20%
- Y₂O₃: 4%

Flexural strength: 2,000 MPa

CTE for ZrO₂ ATZ: 9 × 10⁻⁶/K

Procedure

- Conical part (**4.0 mm**) may be shortened.
- Only process under sufficient, continuous water cooling with slight pressure.
- Use high speed (**water-cooled turbine**) and fine grain size (red-ring diamond, smaller than 50 µm).

1 Marking

Marking (record) of the preparation process.



2 Cutting

Adequate procedure with handpiece: Lightly encircle the preparation position, then expand it in a vertical, V-shaped movement until it is cut through.

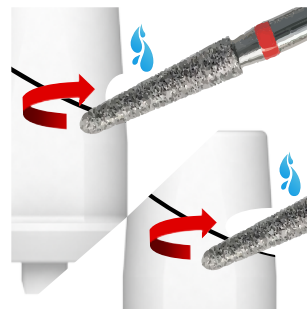

Caution Do not cut through zirconia dioxide that is the same thickness of the instruments or grinding tool.

Risk of overheating!

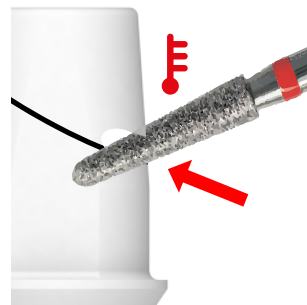

Technical data for NobelPearl screws

Important distinguishing feature of NobelPearl screws

- The NobelPearl™ Lab Screw Inter-X and NobelPearl™ Definitive Clinical Screw Inter-X have no grooves on the screw head and are 1.2 mm shorter than NobelPearl™ Temporary Clinical Screw Inter-X and position locator screws.
- The screw head diameter for all screws is 2.8 mm.
- All screws are suitable for NP, RP and WP.

NobelPearl™ Definitive Clinical Screw Inter-X

Matches	NP/RP/WP Abutment
Distinguishing feature	Length: 7.4 mm No grooves on screw head Black
Tightening torque	min. 20 Ncm max. 25 Ncm
Material	Vicarbo® (carbon-fiber reinforced PEEK)
Technical specifications	Modulus of elasticity: > 160 GPa Flexural strength: > 1,100 MPa Tensile strength: 2,000 MPa
Caution	This screw is intended for the final treatment and may only be used once! It can be tried on with a max. 15 Ncm torque.



NobelPearl™ Lab Screw Inter-X

Matches	NP/RP/WP Abutment
Distinguishing feature	Length: 7.4 mm No grooves on screw head Yellow
Tightening torque	5 Ncm
Material	PEEK
Caution	This screw may only be used in the laboratory and not for the definitive fit!

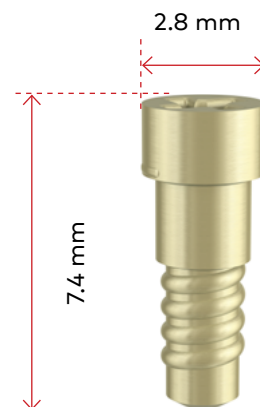

NobelPearl™ Temporary Clinical Screw Inter-X

Matches	NP/RP/WP Temporary Clinical
Distinguishing feature	Length: 8.6 mm Ring on screw head Black
Tightening torque	15 Ncm
Material	Vicarbo® (carbon-fiber reinforced PEEK)
Caution	This screw may only be used for the temporary restoration!



NP



Temporary Abutment

RP



Temporary Abutment

WP



Temporary Abutment

Position Locator Screw

Matches	NP/RP/WP Position Locator
Distinguishing feature	Length: 8.6 mm Ring on screw head Black
Tightening torque	5 Ncm
Material	PEEK-CW30
Caution	This screw may only be used for the position locators!



NP



Position locator

RP



Position locator

WP



Position locator

Order online

Order our complete range of implants and prefabricated prosthetics 24 hours a day through the Nobel Biocare online store.

nobelbiocare.com/store

Order by phone

Call our customer service team or contact your sales representative.

nobelbiocare.com/contact

Lifetime warranty

The warranty covers all Nobel Biocare implants including prefabricated prosthetic components.

nobelbiocare.com/warranty



nobelbiocare.com/nobelpearl

